

DEC 30 1965

LMA790-1

LUNAR EXCURSION MODULE FAMILIARIZATION MANUAL

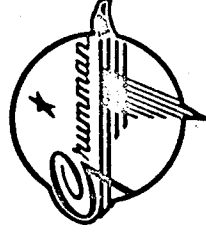

NAS 9-1100

EXHIBIT E, PARAGRAPH 10.2
PRIMARY NO. 830
LINE ITEM 021

(NASA-CR-129890) LUNAR EXCURSION MODULE
FAMILIARIZATION MANUAL (Grumman Aircraft
Engineering Corp.) 15 Oct. 1965 140 p

N73-70028

00/99
Unclas
39257

THIS MANUAL SUPERSEDES LMA790-1 DATED 15 MARCH 1965

PUBLICATIONS SECTION/SERVICE AND PRODUCT SUPPORT DEPARTMENT/GRUMMAN AIRCRAFT ENGINEERING CORPORATION/BETHPAGE/NEW YORK

LMA790-01001C

15 OCTOBER 1965

Technical Library, Bellcomm, Inc.

LIST OF EFFECTIVE PAGES

INSERT LATEST CHANGED PAGES. DESTROY SUPERSEDED PAGES.

NOTE: The portion of the text affected by the changes is indicated by a vertical line in the outer margins of the page.

TOTAL NUMBER OF PAGES IN THIS PUBLICATION IS 138 CONSISTING OF THE FOLLOWING:

Page No.	Issue
Title Page	15 October 1965
"A" Page	15 October 1965
i thru v	15 October 1965
1-1 thru 1-12	15 October 1965
2-1 thru 2-9	15 October 1965
3-1 thru 3-87	15 October 1965
4-1 thru 4-5	15 October 1965
5-1 thru 5-15	15 October 1965
A-1 thru A-4	15 October 1965

*The asterisk indicates pages changed, added, or deleted by the current change

NASA

Manuals will be distributed as directed by the NASA Apollo Project Office. All requests for manuals should be directed to the NASA Apollo Spacecraft Project Office at Houston, Texas.

15 October 1965

Table of Contents

Paragraph	Title	Page
SECTION I - MISSION DESCRIPTION		
1-1	General	1-1
1-2	Flight Development Test Program	1-1
1-7	LEM FDTP Development Flight Instrumentation Equipment	1-1
1-14	LEM Pre-Mission Checks	1-2
1-15	Mission Description	1-2
SECTION II - LEM STRUCTURE		
2-1	General	2-1
2-2	Ascent Stage	2-1
2-11	Descent Stage	2-6
2-13	Interstage Attachments, Umbilicals, and Separations	2-8
SECTION III - OPERATIONAL SUBSYSTEMS		
3-1	General	3-1
3-2	Commander's Displays and Controls	3-1
3-25	System Engineer's Displays and Controls	3-10
3-34	Guidance, Navigation and Control Subsystem	3-11
3-60	Reaction Control Subsystem	3-35
3-66	Propulsion Subsystem	3-41
3-73	Instrumentation Subsystem	3-50
3-79	Communications Subsystem	3-55
3-99	Electrical Power Subsystem	3-66
3-116	Environmental Control Subsystem	3-72
3-122	Crew Provisions	3-79
3-152	Electroexplosive Devices Subsystem	3-84
SECTION IV - PRELAUNCH OPERATIONS		
4-1	General	4-1
4-2	Prelaunch Tests and Operations	4-1
4-3	Acceptance Checkout Equipment - Spacecraft	4-1
4-4	Prelaunch Checkout	4-2
SECTION V - GROUND SUPPORT EQUIPMENT		
5-1	General	5-1
5-2	ACE-S/C Carry-on Equipment and Peripheral Equipment	5-1
5-7	Equipment for Control and Checkout of Spacecraft and Servicing Equipment	5-3
5-34	Servicing Equipment	5-7
5-63	Handling Equipment and Fixtures	5-10
5-84	Bench Maintenance Equipment	5-13
APPENDIX A - LEM SUPPORT MANUALS		
A-1	General	A-1
A-2	Ground Support Equipment Manuals	A-1
A-3	Special Test Equipment Manuals	A-1
A-4	General Purpose Handbooks and Manuals	A-2

List of Illustrations

Figure	Title	Page
SECTION I - MISSION DESCRIPTION		
1-1	Saturn V Launch Vehicle and Payload	1-3
1-2	Mission Profile (3 Sheets)	1-5/1-6
SECTION II - LEM STRUCTURE		
2-1	LEM Structure	2-2
2-2	LEM Dimensions	2-3
2-3	Ascent Stage (2 Sheets)	2-4
2-4	Descent Stage	2-7
2-5	LEM Interface and Explosive Devices Locations	2-9/2-10
SECTION III - OPERATIONAL SUBSYSTEMS		
3-1	LEM Controls and Displays	3-3/3-4
3-2	Commander's and Systems Engineer's Controls and Displays	3-5/3-6
3-3	Primary Guidance Path Simplified Block Diagram	3-13/3-14
3-4	Abort Guidance Path Block Diagram	3-15/3-16
3-5	Primary Guidance and Navigation Section Block Diagram	3-21/3-22
3-6	Landing Radar Block Diagram	3-23/3-24
3-7	Rendezvous Radar Velocity Components	3-25
3-8	Rendezvous Radar Block Diagram	3-27/3-28
3-9	Abort Guidance Section Block Diagram	3-31/3-32
3-10	Control Electronics Section Block Diagram	3-33/3-34
3-11	Reaction Control Subsystem Installation	3-37/3-38
3-12	Reaction Control Subsystem Schematic	3-39/3-40
3-13	RCS Thruster Schematic	3-42
3-14	Descent Propulsion Propellant Supply Sections Schematic	3-44
3-15	Descent Engine Injector and Valves	3-48/3-48
3-16	Ascent Propulsion Propellant Supply Section Schematic	3-49
3-17	Ascent Engine Injector and Valves	3-51/3-52
3-18	Instrumentation Subsystem Block Diagram	3-53/3-54
3-19	Communications Subsystem Block Diagram	3-57/3-58
3-20	In-Flight Communications (Earth Side)	3-60
3-21	In-Flight Communications (Far Side)	3-61
3-22	LEM Lunar Stay Communications	3-62
3-23	Electrical Power Subsystem Equipment Location	3-67/3-68
3-24	Electrical Power Subsystem Functional Block Diagram	3-69/3-70
3-25	Environmental Control Subsystem Installation	3-73/3-74
3-26	Environmental Control Subsystem Schematic	3-75/3-76
3-27	PLSS Donning Station	3-81
3-28	Zero-G Restraint	3-83
3-29	Explosive Devices Locations	3-85/3-86
3-30	Explosive Devices Block Diagram	3-87/3-88
SECTION IV - PRELAUNCH OPERATIONS		
4-1	EIR Checkout Test Summary Chart	4-3/4-4

List of Tables

Table	Title	Page
SECTION III - OPERATIONAL SUBSYSTEMS		
3-1	Primary Guidance Path Modes and Functions	3-17
3-2	Abort Guidance Path Modes and Functions	3-18
3-3	Scientific Instruments	3-56
3-4	Communications Links	3-59
SECTION V - GROUND SUPPORT EQUIPMENT		
5-1	Guidance and Navigation Section BME	5-13
5-2	Stabilization and Control Section BME	5-14
5-3	Electrical Power Subsystem BME	5-14
5-4	Communications Subsystem BME	5-15/5-16
5-5	Controls and Displays BME	5-15/5-16
5-6	Instrumentation Subsystem BME	5-15/5-16
APPENDIX A - LEM SUPPORT MANUALS		
A-1	Ground Support Equipment Manuals	A-1
A-2	Special Test Equipment Manuals	A-2
A-3	General-Purpose Handbooks and Manuals	A-3/A-4

LMA790-1



Artist Conception of Lunar Stay

FOREWORD

This Familiarization Manual provides a general operational description of all subsystems and major components of the LEM. The information contained herein is for orientation and indoctrination purposes. The scope of coverage describes the LEM mission, spacecraft structure, operational subsystems, prelaunch operations, and ground support equipment. A reference index of support manuals developed to date is included in Appendix A.

SECTION I

MISSION DESCRIPTION

1-1. GENERAL.

The Lunar Excursion Module (LEM) System consists of a manned vehicle (module) and related subsystems. The LEM System enables successful completion of the LEM mission, using the concept known as the Lunar Orbital Rendezvous (LOR) technique. The LEM mission, which is part of the overall Apollo mission, begins shortly after separation of the LEM from the Command/Service modules (CSM), continues through lunar descent, lunar stay, and lunar ascent, and ends at rendezvous with the orbiting CSM before the return to earth. Mission abort procedures can be exercised at any time during the mission should it become necessary.

1-2. FLIGHT DEVELOPMENT TEST PROGRAM

Before the LEM can be committed to the lunar mission, its ability to meet the operational requirements of the mission must be demonstrated to assure astronaut safety and mission success. The Flight Development Test Program (FDTP) is intended to provide this assurance by a series of developmental missions in the relative safety of earth orbit.

1-3. LEM-1/206A MISSION

The first developmental mission will consist of a full-up, unmanned LEM and CSM boilerplate No. 30 launched by a Saturn IB. The primary purpose of this mission will be to validate the operational characteristics and performance of the LEM Ascent and Descent Propulsion Subsystems and all flight controls in near-earth orbit.

1-4. LEM-2/207 MISSION

The second developmental mission will be the first manned flight of a complete spacecraft (Command module (CM), Service module (SM), and LEM). The primary purpose of the mission will be to determine the capability of the LEM to provide the environment required during space operations and to rendezvous and dock with the CSM under a variety of operational conditions. Because of the weight limitations imposed by the Saturn IB payload capability, LEM and CSM propellant will be highly offloaded.

1-5. LEM-3/503 MISSION

The third developmental mission will use the Saturn V, the lunar mission launch vehicle, which will enable the spacecraft (LEM, CM, SM) to be fully loaded. The primary purpose of this mission will be to demonstrate further LEM capabilities, confirm rates of consumable expenditures, and prove out proposed time lines for the lunar mission.

1-6. SUBSEQUENT MISSIONS

The missions for LEM-4 and subsequent LEM's are dependent on the success of the initial three LEM's and the manrating of the Saturn V launch vehicle. If the initial missions are successful, the lunar landing mission may be initiated by LEM-4 or soon after. Alternate missions are planned for each of the LEM's to provide for contingencies.

1-7. LEM FDTP DEVELOPMENT FLIGHT INSTRUMENTATION EQUIPMENT.

In support of the FDTP, the basic LEM configuration will be augmented by special equipment, unique to the developmental flights. This development flight instrumentation (DFI) equipment may be classified into three groups: (1) the LEM Mission Programmer (LMP), (2) the on-board DFI, and (3) the DFI tracking equipment.

1-8. LEM MISSION PROGRAMMER.

The LEM Mission Programmer (LMP) will provide the LEM with the capability of unmanned operations by activating functions which are normally performed by an astronaut to accomplish test objectives. The LEM has three modes of operation: prime, backup, and ground command.

1-9. Prime Mode. The prime mode provides command intelligence from a program stored in the LEM Guidance Computer (LGC), through the basic LEM subsystem interfaces and the Program Coupler Assembly (PCA), to the subsystems to provide vehicle control. It can provide all functions required to accomplish unmanned mission objectives and has the capability of open- or closed-loop or both, guidance as required by the mission profile.

1-10. Backup Mode. The backup mode, which will be used only in the event of a prime-mode malfunction, provides command intelligence from a series of command sequences stored in the Program Radar Assembly (PRA), through the PCA, to the subsystems to provide vehicle control. Its capability is limited to open-loop, time-sequenced commands. It will be required to activate only those functions required to accomplish objectives constraining subsequent flights.

1-11. Ground Command Mode. The ground command mode provides ground-initiated command intelligence for contingency situations. The ground commands are sent to the Digital Command Assembly (DCA) where they are processed and routed to (1) the LGC for updating and program selection; (2) the PRA for program initiations, termination, and selection control, or (3) the PCA for routing to the subsystems to correct LMP relay or subsystem malfunctions that would otherwise jeopardize subsequent vehicle-test capability.

1-12. On-Board Development Flight Instrumentation.

To satisfy the objectives of the FFTP, engineering data beyond that supplied by the basic LEM instrumentation will be required. This additional data will be accommodated on the developmental flights by the inclusion of special on-board DFL. This equipment will consist of a number of fm/fm telemetry links that radiate LEM-generated data not required for real-time display, and a single pcm/fm unit for real-time control purposes.

The vhf telemetry links will consist of Inter-Range Instrumentation Group (IRIG) standard proportional bandwidth pcm/fm/fm. AIA standard constant bandwidth fm/fm, and pcm/fm transmitting systems. The pcm/fm system will radiate the output of the Operational Pulse code modulation and timing equipment (PCMTE) to ensure receipt of this information during a near-earth mission. The number of each of these systems used will be determined by the requirements of the individual missions.

These telemetry systems will contain all components necessary to sense, condition, commutate, multiplex, modulate, and radiate the additional data requirements of the developmental missions.

1-13. DEVELOPMENT FLIGHT INSTRUMENTATION TRACKING EQUIPMENT.

The DFI tracking equipment will be a C-band transponder system consisting of two line filters, two AN/DPN-66 transponders, two power dividers, and four antennas. The system will facilitate radar tracking of the LEM during FFTP near-earth missions when the (operational) S-band is not a fully qualified system. To accomplish this function, the transponders receive a pulse-type signal via their antennas and transmit back to earth a pulse-type signal at a different frequency over the same antennas.

1-14. LEM PRE-MISSION CHECKS.

Before earth launch, the LEM System is subjected to rigorous checks to achieve maximum mission reliability and astronaut safety. System acceptance and functional tests, integrated equipment tests, assembly tests, launch pad tests, and countdown operational tests permit constant system-monitoring. During these tests, each subsystem is checked to the extent possible without equipment removal. A general-purpose spacecraft-checkout system, the Acceptance Checkout Equipment - Spacecraft (ACE-S/C), is used for computer-controlled or manually controlled acceptance tests and prelaunch tests of the LEM System. The LEM System is exercised through its modes of operation, redundancies are isolated and checked, and diagnostic routines are performed to the replaceable-unit level.

1-15. MISSION DESCRIPTION.

The objective of the Apollo mission is to land two astronauts and scientific equipment on the surface of the moon and to return them safely to earth. The mission has the following phases: earth ascent, earth parking orbit, translunar coast, lunar orbit, lunar descent, lunar stay, lunar ascent, rendezvous and docking, and LEM jettison.

1-16. SATURN V LAUNCH VEHICLE AND PAYLOAD. (See figure 1-1.)

The Saturn V is the launch vehicle used in the Apollo program to boost the payload used to perform the manned lunar landing and return. This three-stage vehicle consists of the S-IC first-stage booster, the

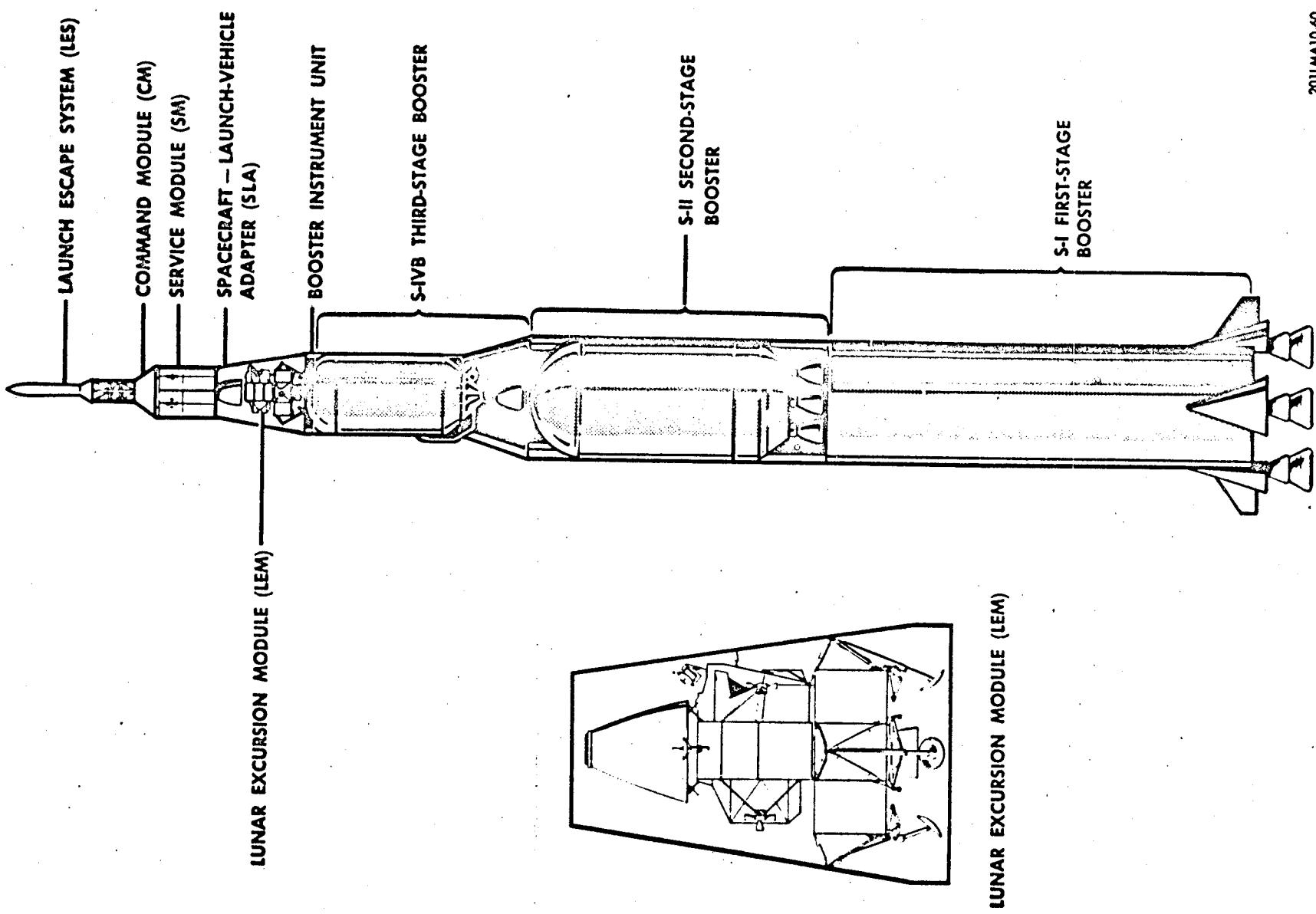

201LMA10-60

Figure 1-1. Saturn V Launch Vehicle and Payload

S-II second-stage booster, and the S-IVB third-stage booster. The payload consists of the Command Module (CM), Service Module (SM), Lunar Excursion Module (LEM), and the Spacecraft - Launch Vehicle Adapter (SLA). The Command Module houses the three astronauts (Commander, Systems Engineer, and Navigator) before and subsequent to lunar operations. The Booster Instrument Unit, located between the Service Module and the S-IVB, controls each of the three stages during flight. The overall length of the Saturn V Launch Vehicle and Payload is 361 feet.

1-17. S-IC First-Stage Booster. The S-IC first-stage booster is 33 feet in diameter, 138.5 feet in length, and uses five F-1 engines. Each F-1 engine, burning RP-1 and liquid oxygen, produces 1,500,000 pounds of thrust, thus yielding an overall boost of 7,500,000 pounds.

1-18. S-II Second-Stage Booster. The S-II second-stage booster is 33 feet in diameter and approximately 82 feet in length and employs five J-2 engines. Each J-2 engine, burning liquid hydrogen and liquid oxygen, produces 200,000 pounds of thrust for an overall boost of 1,000,000 pounds.

1-19. S-IVB Third-Stage Booster. The S-IVB third-stage booster produces 200,000 pounds of thrust.

1-20. Earth Vicinity and Translunar Coast. (See figure 1-2, sheet 1 of 3.) The Saturn launch vehicle inserts the spacecraft and the S-IVB stage (which is attached to the Spacecraft-Launch Vehicle Adapter (SLA)) into an earth orbit. The landing gear of the LEM is folded and the antenna retracted when the LEM is installed inside the SLA.

When earth orbit is achieved, the S-IVB stage is shut down and the three astronauts in the CM perform CSM subsystem checks in preparation for translunar injection. Landmark sightings and other guidance and navigation tasks (for example, attitude reference systems alignments) are performed while in earth orbit. Upon completion of earth orbit (nominally two revolutions), the S-IVB engine is restarted to begin translunar injection.

After the initial translunar coasting period, the CSM detaches from the SLA and S-IVB stage, pitches 180° in free flight, and docks with the docking hatch of the LEM - a maneuver called transposition and docking. During transposition and docking, the LEM/S-IVB stage is stabilized by the S-IVB instrumentation unit. Upon completion of transposition and docking, the S-IVB stage and the SLA are jettisoned and the CSM and the LEM are oriented for continuation of the translunar coast period. During translunar coast, the LEM remains passive, except for the Inertial Measurement Unit (IMU) heaters and portions of the Environmental Control Subsystem (ECS) and Electrical Power Subsystem (EPS), which were activated before launch. The CM performs all navigation and guidance functions and, oriented by the SM reaction controls, initiates midcourse correction maneuvers by means of the Service Module Propulsion Subsystem thrusting.

1-21. LUNAR VICINITY. (See figure 1-2, sheet 2 of 3.)

Approximately 64 hours after launch, the SM Propulsion Subsystem inserts the LEM and CSM into a circular lunar orbit of approximately 80 nautical miles above the lunar surface. During the early part of this orbit, the astronauts perform IMU alignments; landmark sightings for orbit determination; and Guidance, Navigation, and Control (GN & C) Subsystem updating. Upon completion of this phase, the LEM is pressurized from the CM and the LEM internal environment is checked. The Commander and Systems Engineer enter the LEM through the docking hatch; the Navigator remains in the CM. The astronauts in the LEM check out each subsystem, and perform IMU optical alignment of the GN & C Subsystems using the alignment optical telescope (AOT). The inertial attitude reference assembly of the LEM abort guidance section is then aligned with respect to the GN & C Subsystem. Upon completion of the checkout, and at a predetermined point in lunar orbit, the Reaction Control Subsystem (RCS) separates the LEM from the CSM. The astronauts realign the IMU and check the tracking capability of the rendezvous and landing radars in preparation for descent to the lunar surface.

The Descent Propulsion Subsystem inserts the LEM into Hohmann elliptical transfer orbit. This descent orbit has a pericyynthion of 50,000 feet approximately 225 miles uprange of the proposed landing site. During the initial part of the descent transfer orbit coast, the orbital path is verified by rendezvous radar tracking by LEM and optical tracking by CSM. Near the end of this orbit, the astronauts update the IMU of the GN & C Subsystem by star-sightings in preparation for the next powered phase. At the conclusion of the descent transfer orbit coast phase, the descent engine cuts off and the LEM begins its coast towards pericynthion. The GN & C maintains the attitude of the LEM during all coast phases and main rocket engine firings. The descent engine is fired when the LEM arrives at the pericynthion, to reduce the velocity during descent to the lunar surface. The braking phase is performed at near-maximum descent-engine thrust along a near-optimum (minimum fuel) trajectory. The landing site is not visible during this phase due to the high pitch angles required for the braking maneuver.

EARTH VICINITY AND TRANSLUNAR COAST

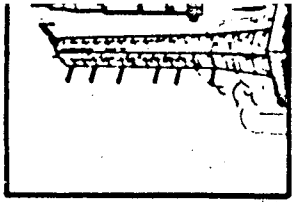

1. (00:00:00)
LIFTOFF

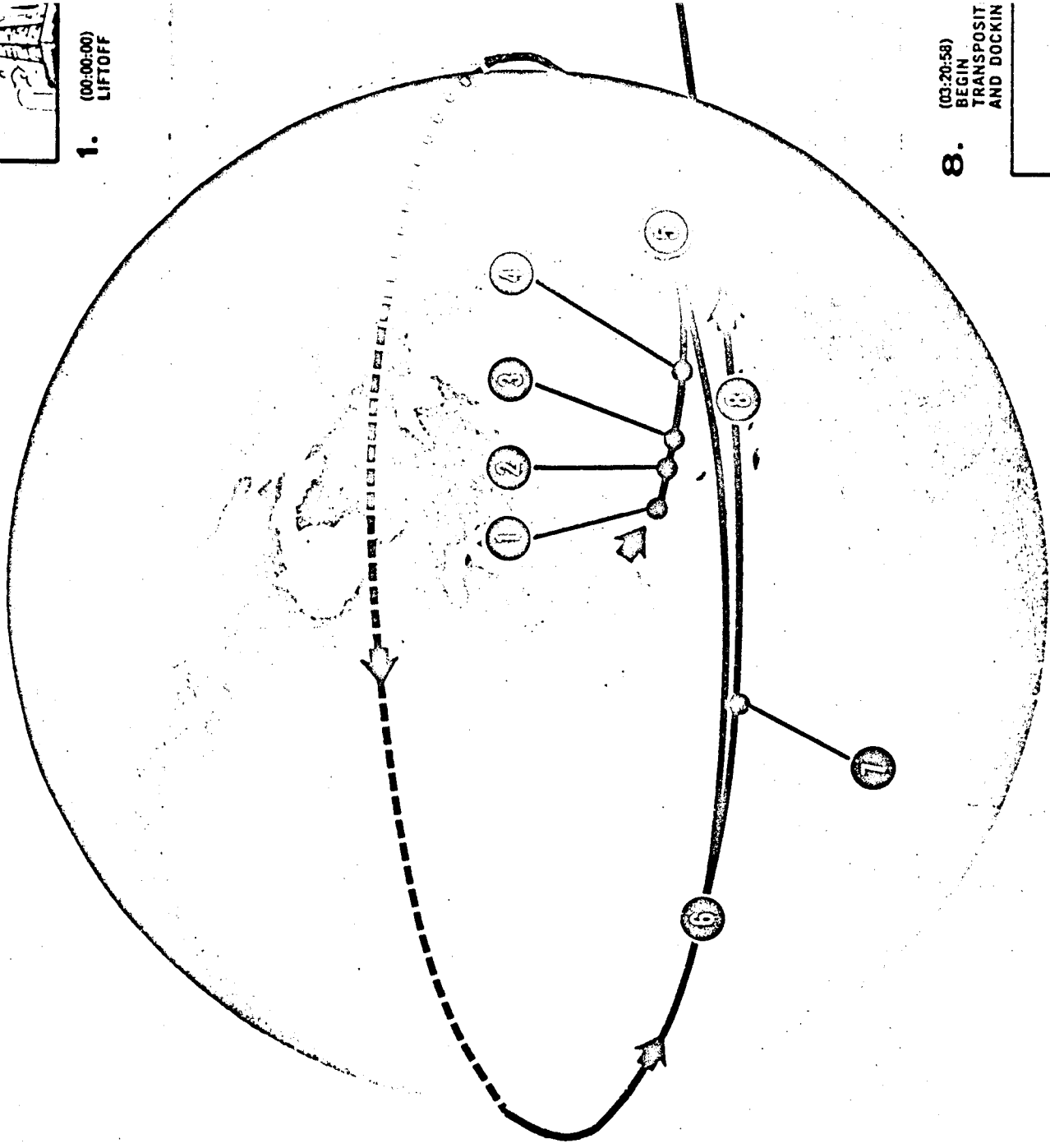

8.

(03:20:58)
BEGIN
TRANSPOSIT
AND DOCKIN

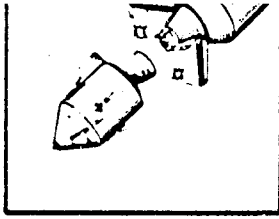

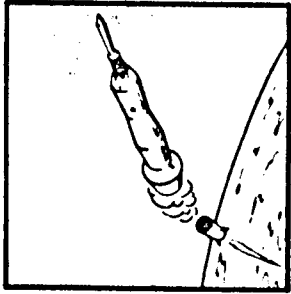

2. (00:02:34)
BEGIN S-II
THRUSTING

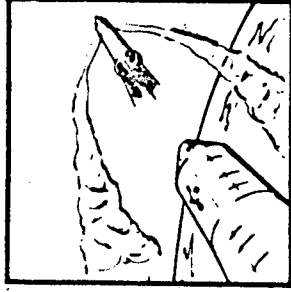

3. (00:02:54)
JETTISON LAUNCH
ESCAPE SYSTEM

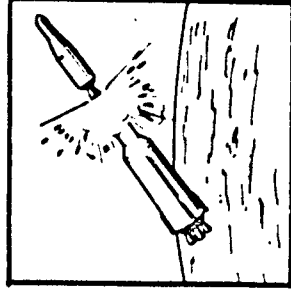

4. (00:09:04)
BEGIN S-IVB
THRUSTING

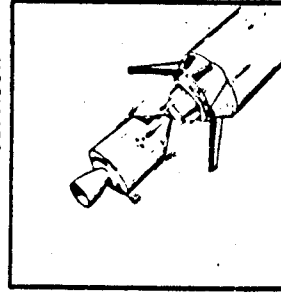
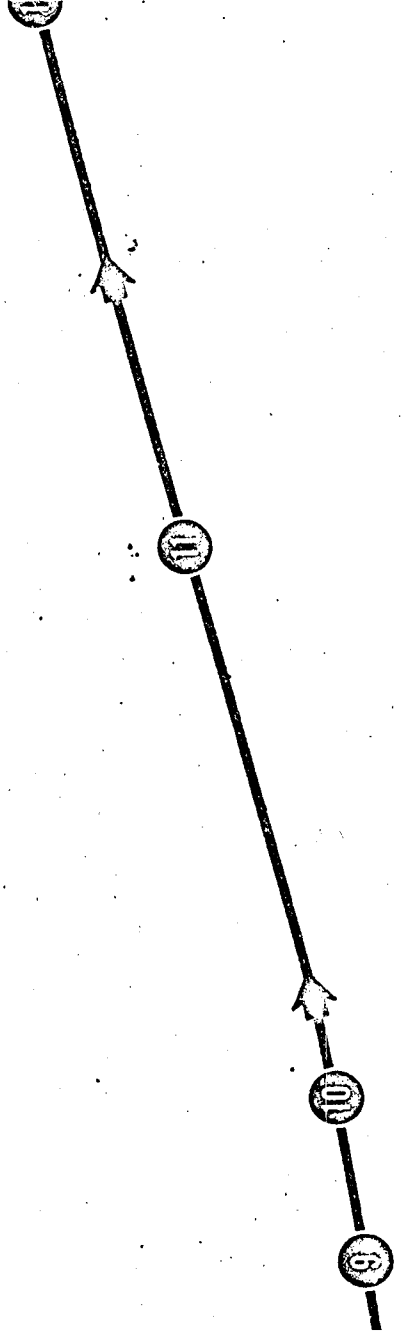

9. (03:47:58)
CSM DOCKED—
BEGIN COAST THROUGH
S-IVB JETTISON

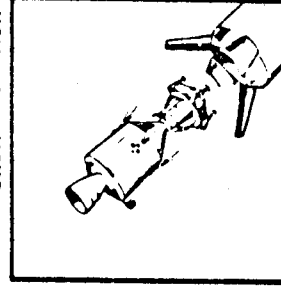

10. (03:50:58)
JETTISON S-IVB—
BEGIN COAST TO LUNAR
ORBIT INSERTION



11. (05:05:58)
FIRST MIDCOURSE
CORRECTION

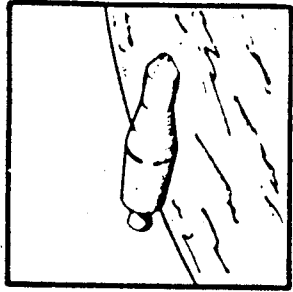

5. (00:11:52)
EARTH ORBIT
INSERTION

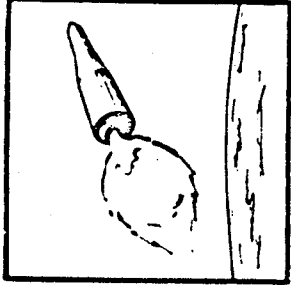

6. (03:00:43)
BEGIN TRANSLUNAR
INJECTION ON
SECOND ORBIT

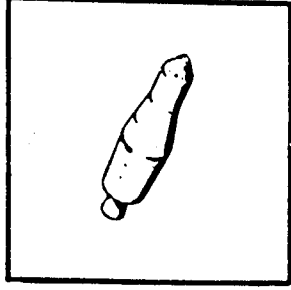

7. (03:05:59)
BEGIN INITIAL COAST
TO TRANSPOSITION
AND DOCKING

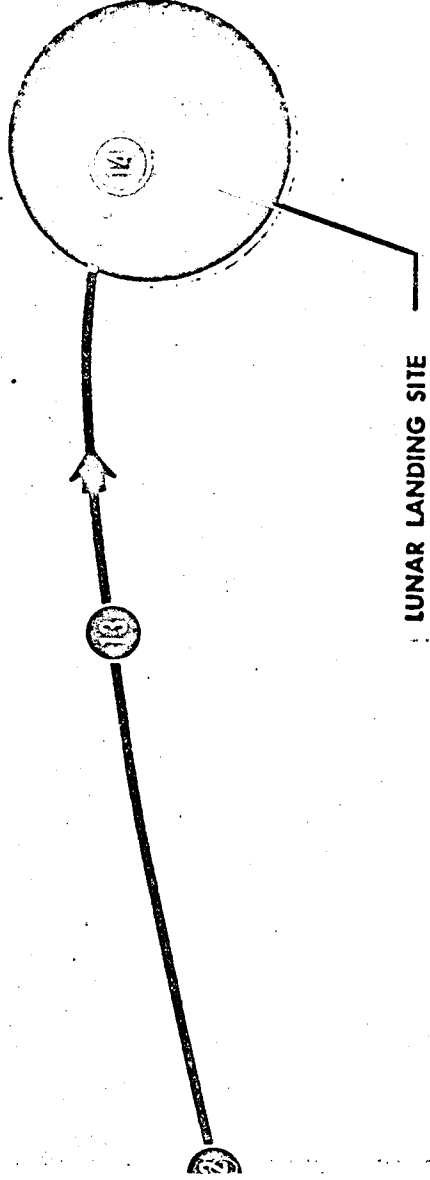

12. (55:30:00)
SECOND
MIDCOURSE
CORRECTION

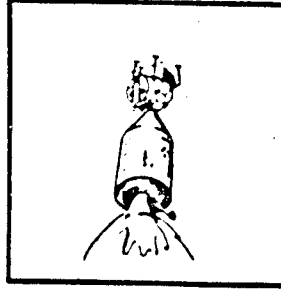

13. (63:15:04)
THIRD MIDCOURSE
CORRECTION



14. (64:15:04)
BEGIN LUNAR
ORBIT INSERTION

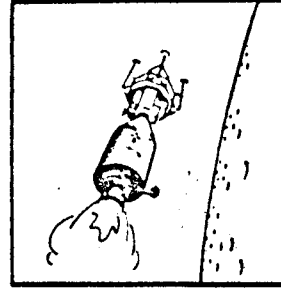

B-201LMA10-13-1

Figure 1-2. Mission Profile (Sheet 1 of 3)

LUNAR VICINITY

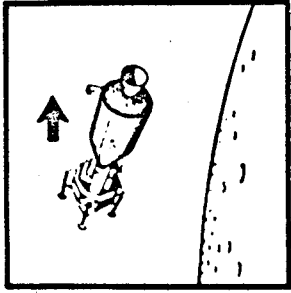

15. (64:20:56)
BEGIN LUNAR
ORBIT COAST

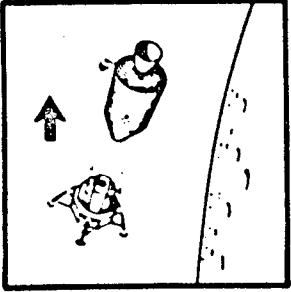

16. (68:04:14)
LEM-CSM
SEPARATION ON
SECOND ORBIT

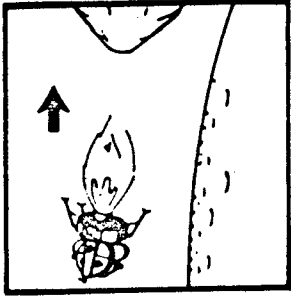

17. (68:24:14)
BEGIN TRANSFER
ORBIT INSERTION

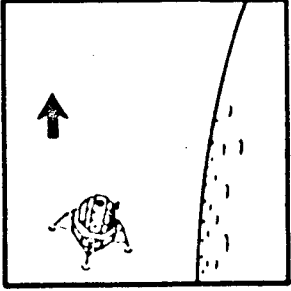

18. (68:24:48)
BEGIN COAST TO
INITIATION OF
POWERED DESCENT

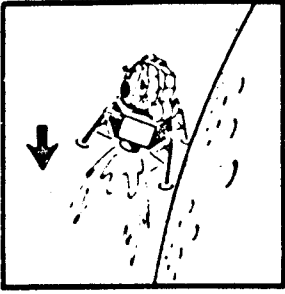

19. (69:22:53)
BEGIN POWERED
DESCENT BRAKING
PHASE

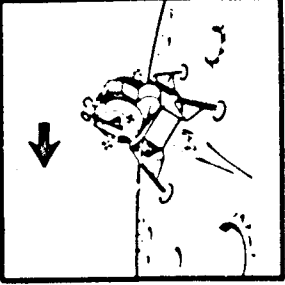

20. (69:29:23)
BEGIN FINAL
APPROACH PHASE

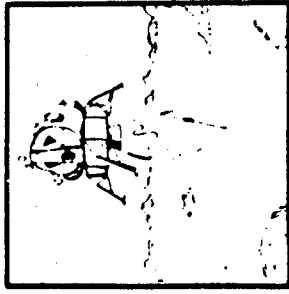

21. (69:31:18)
BEGIN LANDING
PHASE



22. (69:32:23)
TOUCHDOWN

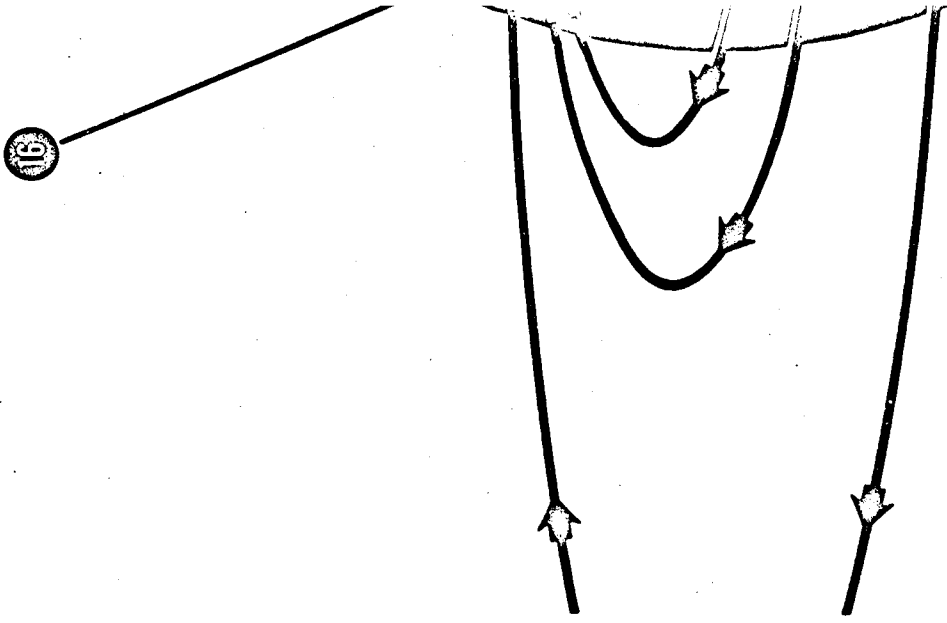

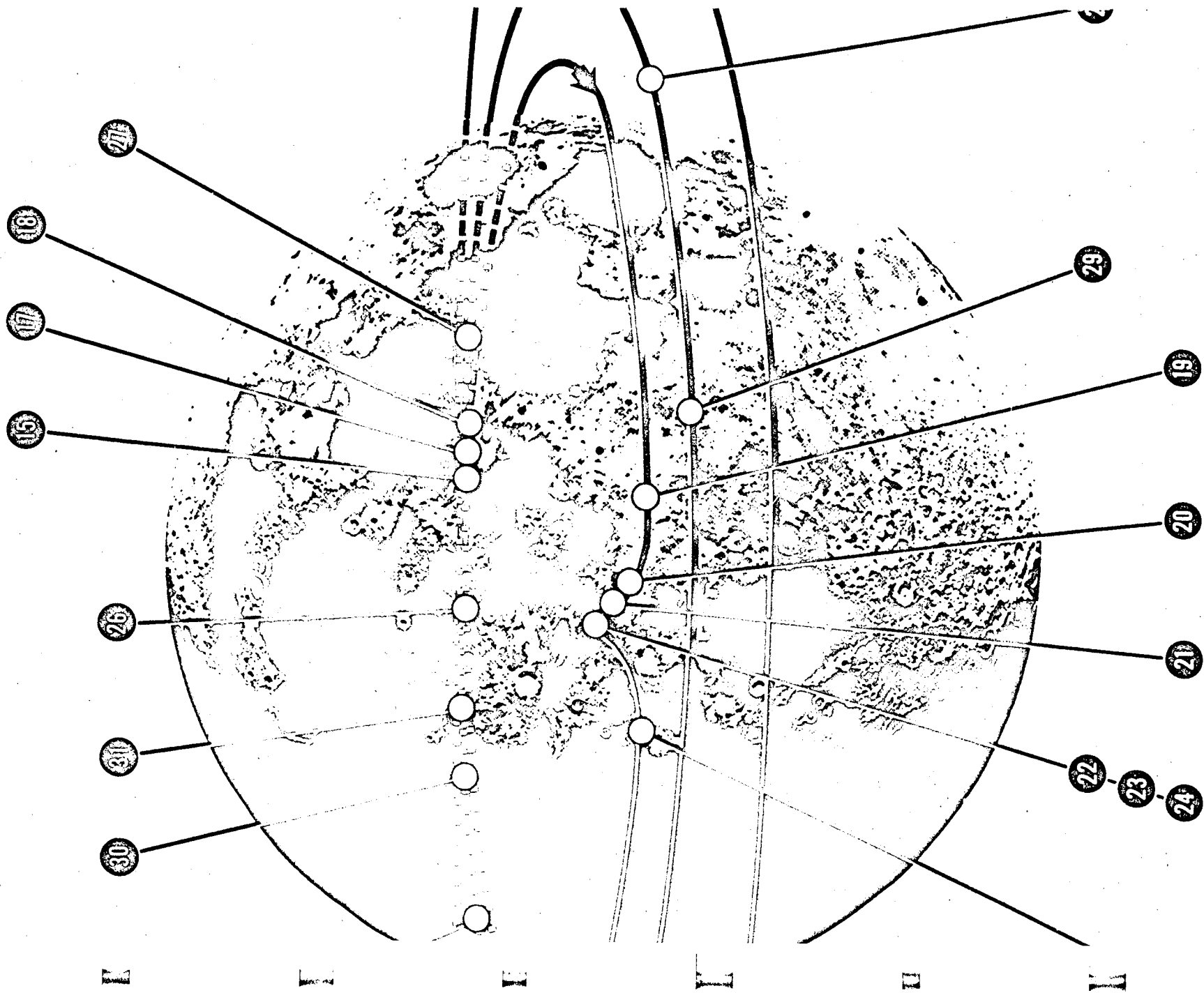

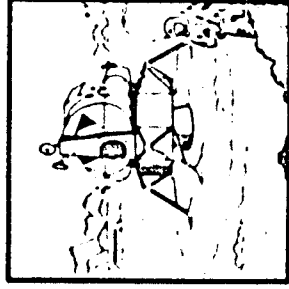

23. LEM LUNAR STAY FOR 34:44:43 HOURS



24. (104:17:06) BEGIN POWERED ASCENT ON 20th CSM ORBIT

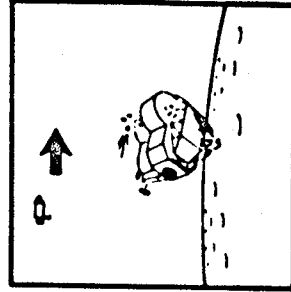
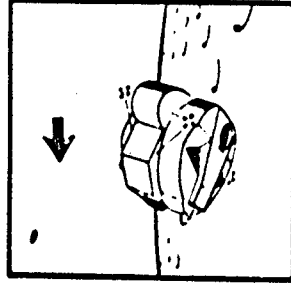

25. (104:24:09) BEGIN COAST TO TERMINAL RENDEZVOUS

26. (105:11:00) BEGIN TERMINAL RENDEZVOUS

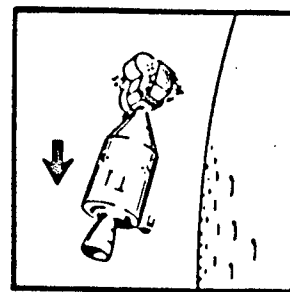
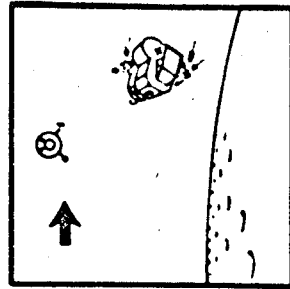

27. (105:19:16) BEGIN DOCKING

28. (105:44:16) HARD DOCK - BEGIN LUNAR ORBIT COAST TO TRANSEARTH INJECTION

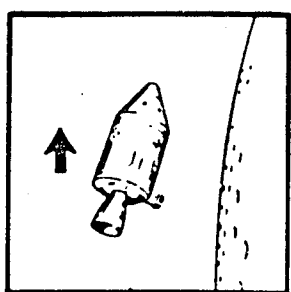
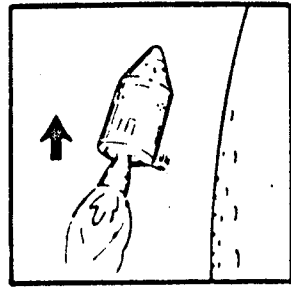

29. (106:14:16) JETTISON LEM

30. (109:08:13) BEGIN TRANSEARTH INJECTION ON 22nd ORBIT

31. (109:09:56) BEGIN TRANSEARTH COAST

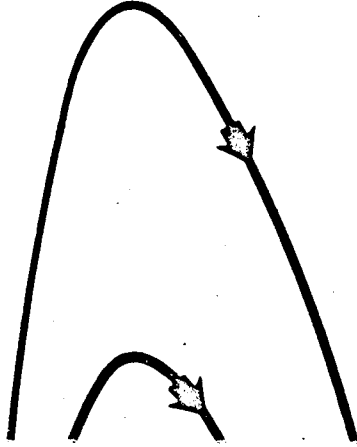
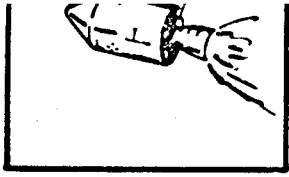
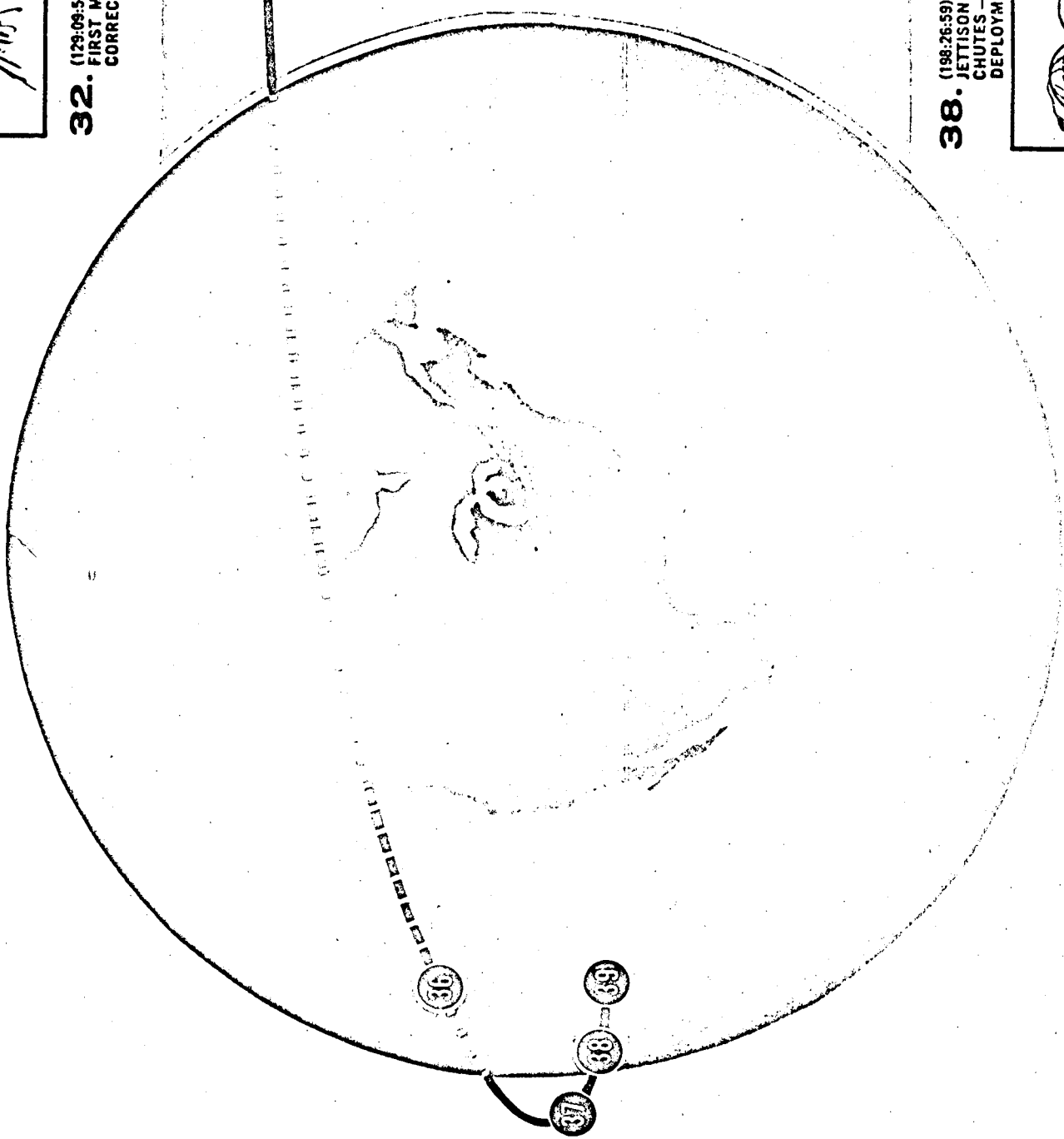

Figure 1-2. Mission Profile (Sheet 2 of 3)

TRANSEARTH COAST AND ENTRY



32. (129:09:5)
FIRST M
CORREC



38. (198:26:59)
JETTISON
CHUTES -
DEPLOYM

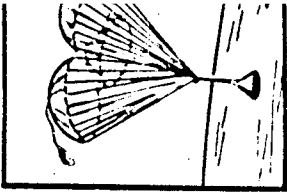



COURSE
N

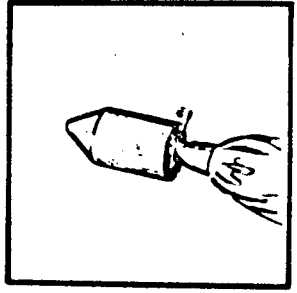

33. (174-09:56)
SECOND
MIDCOURSE
CORRECTION

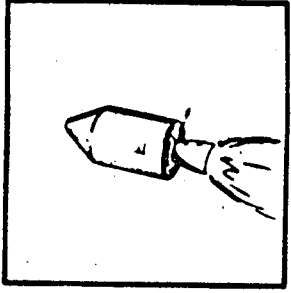

34. (197:15:34)
THIRD MIDCOURSE
CORRECTION

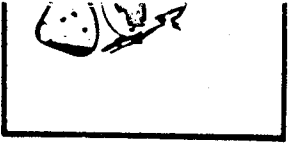

35. (198:0X)
JETTI

35

34

33

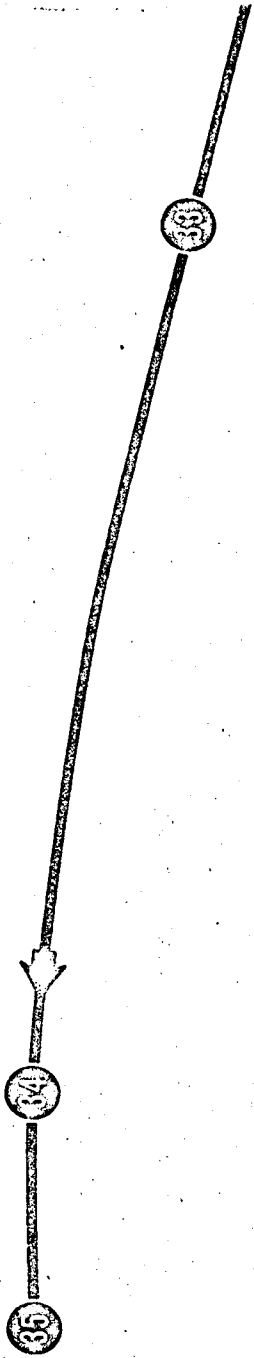

OGUE
IN CHUTE



39. (198:33:08)
EARTH LANDING



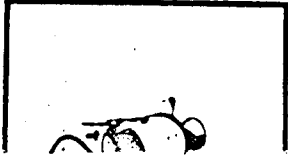

1:34
50N 5M

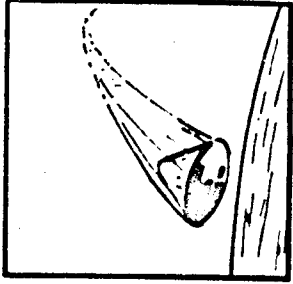

36. (198:15:34)
ENTRY INTO
EARTH'S
ATMOSPHERE

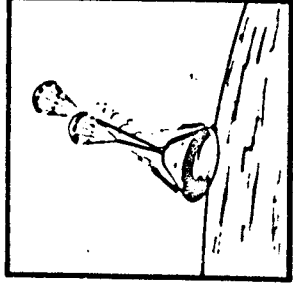

37. (198:28:01)
BEGIN PARACHUTE
DESCENT

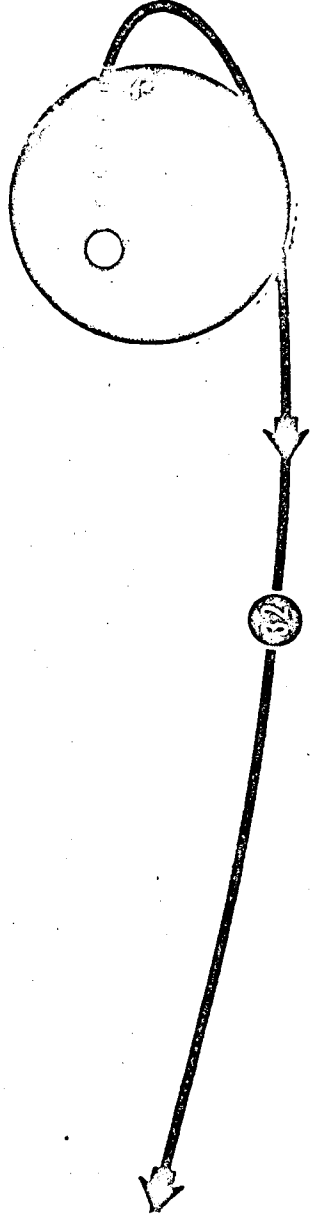

Figure 1-2. Mission Profile (Sheet 3 of 3)

At pericyynthion of the descent transfer orbit, the descent engine of the Propulsion Subsystem is fired to initiate powered descent. Descent to the lunar surface consists of three distinct phases: the braking phase from approximately 50,000 to 10,000 feet (high gate), a final approach phase from approximately 10,000 feet to 700 feet (low gate) during which the landing site is observable, and the landing phase, which terminates at touchdown. Descent is performed automatically under control of the GN & S Subsystem to approximately 700 feet above the lunar surface.

Approximately 2 minutes before reaching the low-gate point, the LEM is oriented to begin the final approach phase. During the final approach phase, the LEM descends to the low-gate point at nearly constant flight path angle; the attitude of the LEM is such that the astronauts can observe gross landing area details and generate new information for the GN & C Subsystem to guide the LEM to an alternate landing site, if necessary.

At the low-gate point, the astronauts in the LEM can select the best landing site and perform the landing phase to touchdown. To accomplish translation to a desired spot on the lunar surface, the thrust vector can be tilted to accelerate the LEM in the direction of the landing site. At approximately 3 feet above the lunar surface, the engine is cut off and the LEM free-falls to the lunar surface.

After touchdown on the lunar surface, the two astronauts check all subsystems to determine whether damage occurred upon landing and to assure that all systems can perform the functions required for a successful ascent. The decision is then made whether the nominal planned stay-time operations can be executed. If all the systems check out satisfactorily, the astronauts observe the surrounding lunar landscape, check the LEM hatches, and perform a final check of the portable life support system (PLSS) in preparation for one of the astronauts to leave the LEM. All equipment not essential for lunar stay is turned off.

After the LEM is secured for lunar stay, it is depressurized and one astronaut leaves to explore the lunar surface. The LEM is then pressurized. The exterior of the LEM is inspected by the extravehicular astronaut (EVA) and an erectable S-band communication antenna is deployed. A television system is used to send pictures of the lunar topography back to earth via an S-band link. Photographic records are made, samples of the lunar surface are collected, and other scientific operations are performed. The EVA is always in direct visual and voice contact with the astronaut inside the LEM. After approximately 3 hours of exploration, the LEM is depressurized and the EVA enters. After the LEM is pressurized the PLSS is replenished. The PLSS can be used for a total of eight 3-hour excursions. A voice report is made to earth via the S-band link and pertinent scientific data is transmitted and recorded. Additional lunar-surface exploration will be performed in accordance with the planned stay time.

When the lunar stay is completed, the astronauts prepare the LEM for launch and ascent. A complete check is made of all subsystems. The GN & C Subsystem and the Abort Guidance Section are optically aligned. The AOT obtains celestial data for alignment of the IMU. The location of the LEM relative to the orbiting CSM is determined and stored in the LGC for later use during the ascent maneuver.

Because the LEM descent stage is left behind at launch, all connections between the ascent and descent stages (including cabling and piping) are severed just before launch. The ascent stage is then ready for launch from the lunar surface and eventual rendezvous with the orbiting CSM. Nominal launch time occurs when the CSM is slightly uprange from its zenith position over the LEM. Assuming the LEM is launched at this time, or up to 1-1/2 minutes late, the ascent engine will burn continuously from liftoff to insertion into an ascent transfer orbit (approximately 7 minutes). The ascent trajectory begins with a vertical rise for 12 seconds, followed by two pitchover phases (one at a high pitch rate; a final one, at a comparatively low pitch rate). Burnout occurs at 50,000 feet. At this point, the LEM is in an ascent transfer orbit, which intercepts the CSM at the first intersection of the LEM and CSM orbits.

If lunar launch is delayed more than 1-1/2 minutes, a stay in a 50,000-foot-altitude parking orbit is required before a second engine burn for insertion into an ascent transfer orbit with either the ascent engine or the RCS. If lunar launch is delayed approximately 8 minutes, the CSM disappears below the horizon and launch would be performed approximately 2 hours later, at the next "on-time" launch occurrence.

When the LEM is approximately 500 feet from the CSM, the Commander manually maneuvers the LEM to a docking attitude and increases or decreases the rate of closure until complete docking is accomplished. The CSM normally remains passive during rendezvous and docking, although it also can accomplish rendezvous and docking, if necessary.

1-22. TRANSEARTH COAST AND ENTRY. (See figure 1-2, sheet 3 of 3.)

After docking is completed, the LEM is secured to the CSM and the Commander and Systems Engineer prepare for transfer to the CM. Pressures are equalized, LEM subsystems are turned off, and scientific equipment and samples are transferred to the CM. After the two astronauts transfer to the CM through the INGRESS/EGRESS hatch, the LEM is jettisoned. This concludes the LEM mission.

A brief checkout of the CSM and pre-ignition preparation are made before SM engine firing. The SM engine is then fired to inject the CSM into the required transearth orbit. The SM is jettisoned approximately 15 minutes before entry into the earth's atmosphere and the CM is oriented for entry and landing.

SECTION II

LEM STRUCTURE

2-1. GENERAL. (See figure 2-1.)

The LEM consists of a descent stage and an ascent stage. Provision is made for separating the stages and the interconnecting umbilicals at lunar launch and in the event of a mission abort.

See figure 2-2 for approximate dimensions and front, side, and top views of the LEM. The approximate weight of the LEM at earth launch is 32,500 pounds.

2-2. ASCENT STAGE. (See figure 2-3.)

The ascent stage is the manned portion of the LEM and will carry two astronauts. Flight, lunar landing, lunar launch, and rendezvous and docking with the Command/Service module (CSM) are controlled from the crew compartment. The entire pressurized compartment of the ascent stage is the cabin. The compartment of the cabin forward of +Z27 is the forward cabin section and the compartment of the cabin from +Z27 to -27 is the midsection. The crew compartment of the cabin which is the forward cabin section is used as the operations center for the astronauts during all crew operations. In addition, the ascent stage consists of the aft equipment bay, tank sections, engine supports, windows, tunnels, and hatches. Air pressure and temperature within the crew compartment and midsection, are controlled by the Environmental Control Subsystem (ECS). Stowage is provided for items such as food, LiOH cartridges, spare parts, gloves, boots and scientific equipment in the midsection.

2-3. STRUCTURE.

The ascent stage is constructed of aluminum alloy. A structural skin which is surrounded by a complete layer of insulation and a thin aluminum skin provides thermal and micrometeoroid protection for the astronauts. The outer skin is approximately 3 inches from the inner structural skin. The cabin is a 92-inch diameter cylinder stiffened by 2-inch deep circumferential frames. The frames are spaced approximately 10 inches apart and are located between the structural skin and the outer or thermal shield.

The cabin has two triangular windows in the front-face bulkhead, an overhead docking window on the left side, a forward hatch, controls and displays, and items necessary for astronaut comfort and support.

2-4. FORWARD CABIN SECTION.

The forward cabin section or crew compartment is used as the crew operations center. The compartment contains most of the controls and instrument panels that are required for LEM operations.

2-5. MIDSECTION.

The midsection is a smaller compartment directly behind the cabin. The ascent engine is aligned with the center of gravity in the midsection. The ascent engine valves are accessible when the removable cover that extends above the deck in the midsection is removed. In addition, the midsection has the docking hatch, Environmental Control Subsystem (ECS), and stowage for equipment that must be accessible to the astronauts.

2-6. TUNNELS.

The docking tunnel, at the top centerline of the ascent stage, is used for docking when transposition is performed, for transfer of two astronauts to the LEM after injection into lunar orbit, for docking after rendezvous in lunar orbit, and for transfer of the LEM crew and scientific payload to the Command Module. The INGRESS/EGRESS tunnel at the lower portion of the forward cabin section, is used for entering and leaving the LEM while on the lunar surface and for extravehicular transfer of crew and equipment in space. Pressure-tight, plug-type hatches in each tunnel are manually controlled and are sealed with preloaded silicone elastomeric seals.

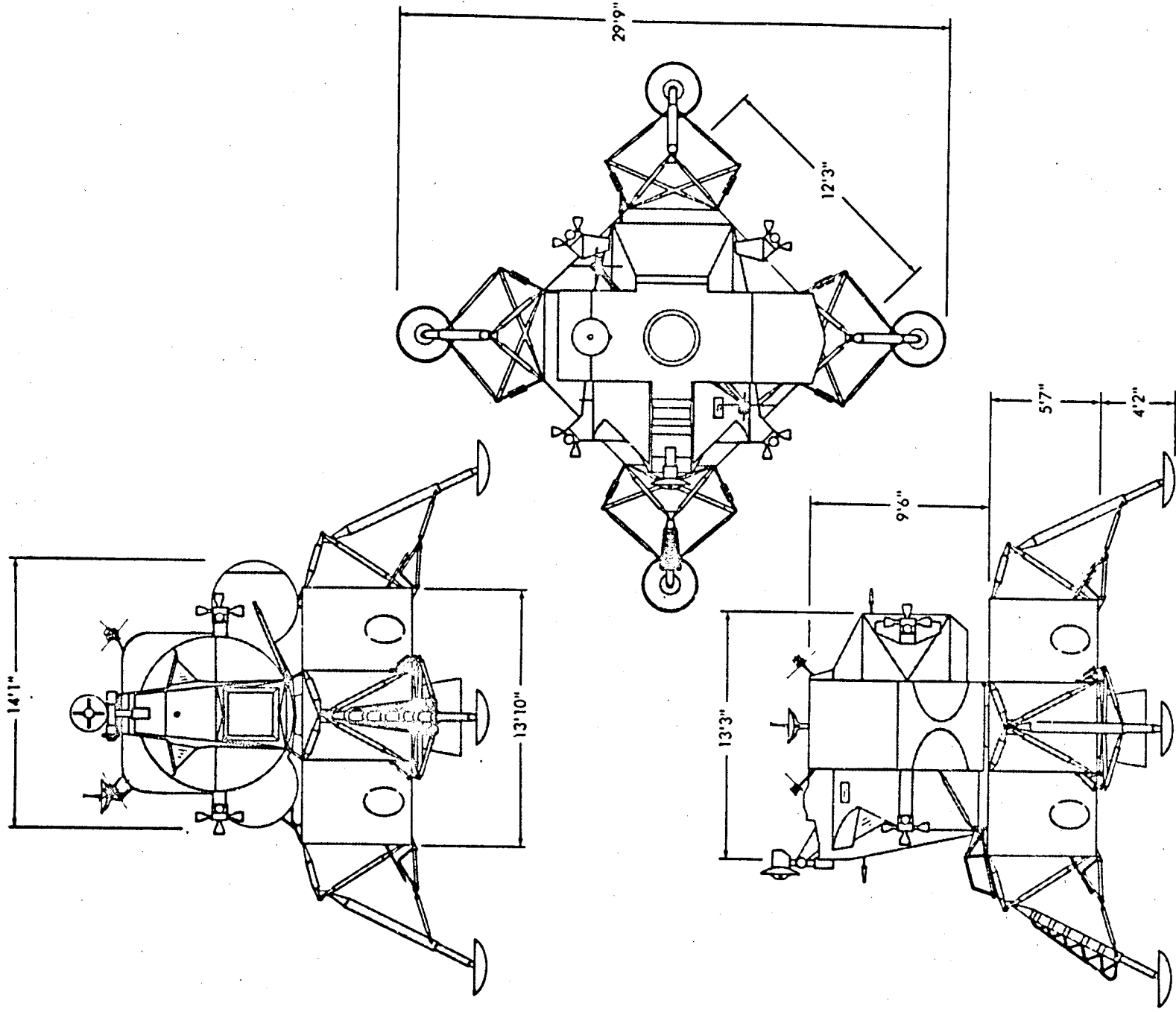
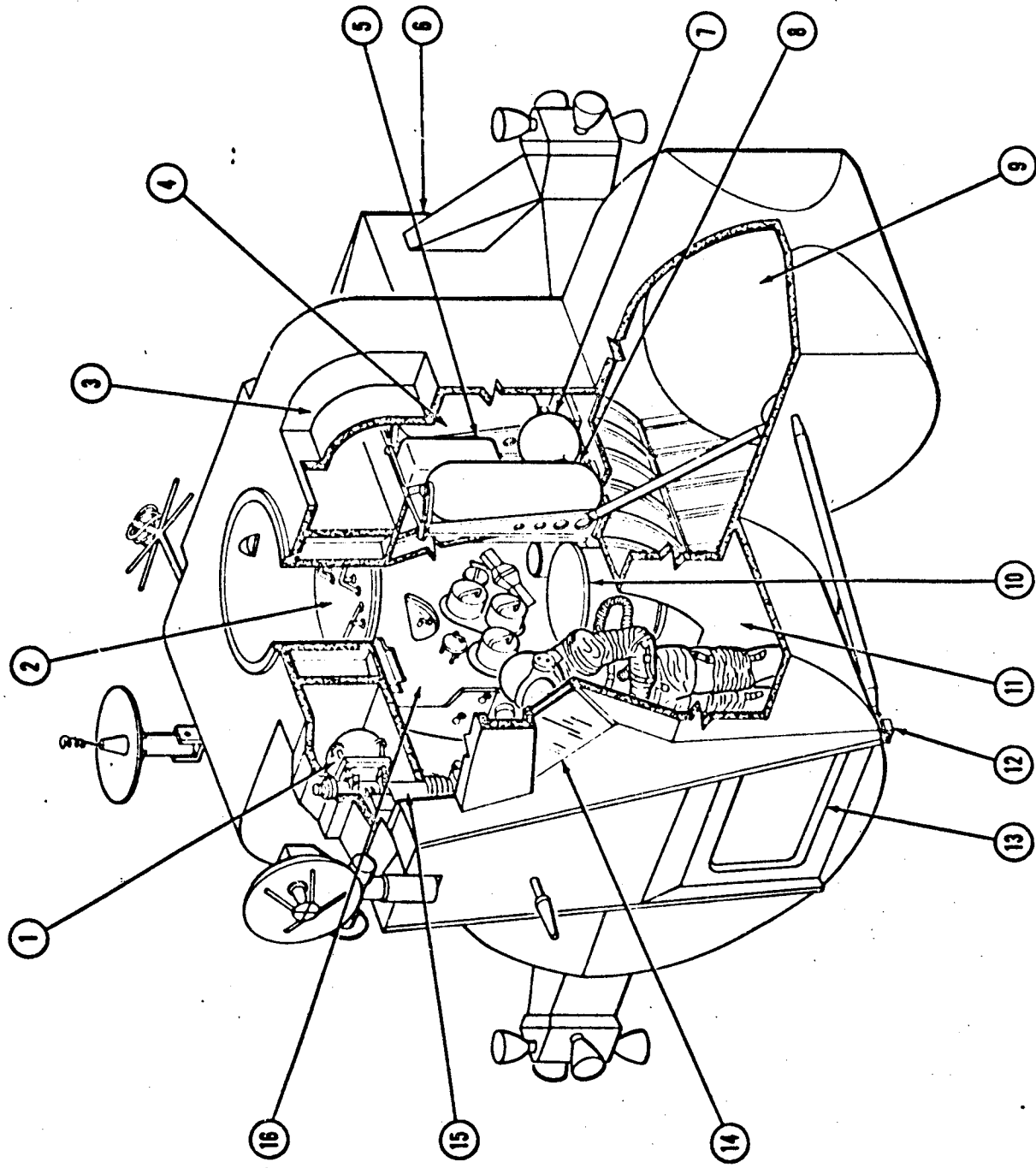

Figure 2-2. LEM Dimensions



- 1. INERTIAL MEASURING UNIT
- 2. DOCKING HATCH
- 3. DOCKING TARGET RECESS
- 4. FUEL TANK (RCS)
- 5. HELIUM PRESSURE REGULATING MODULE
- 6. AFT EQUIPMENT BAY
- 7. HELIUM TANK (RCS)

- 8. OXIDIZER TANK (RCS)
- 9. FUEL TANK
- 10. ASCENT ENGINE COVER
- 11. CREW COMPARTMENT
- 12. FORWARD INTERSTAGE FITTING
- 13. INGRESS/EGRESS HATCH
- 14. CABIN WINDOW
- 15. ALIGNMENT OPTICAL TELESCOPE
- 16. MIDSECTION

Figure 2-3. Ascent Stage (Sheet 1 of 2)

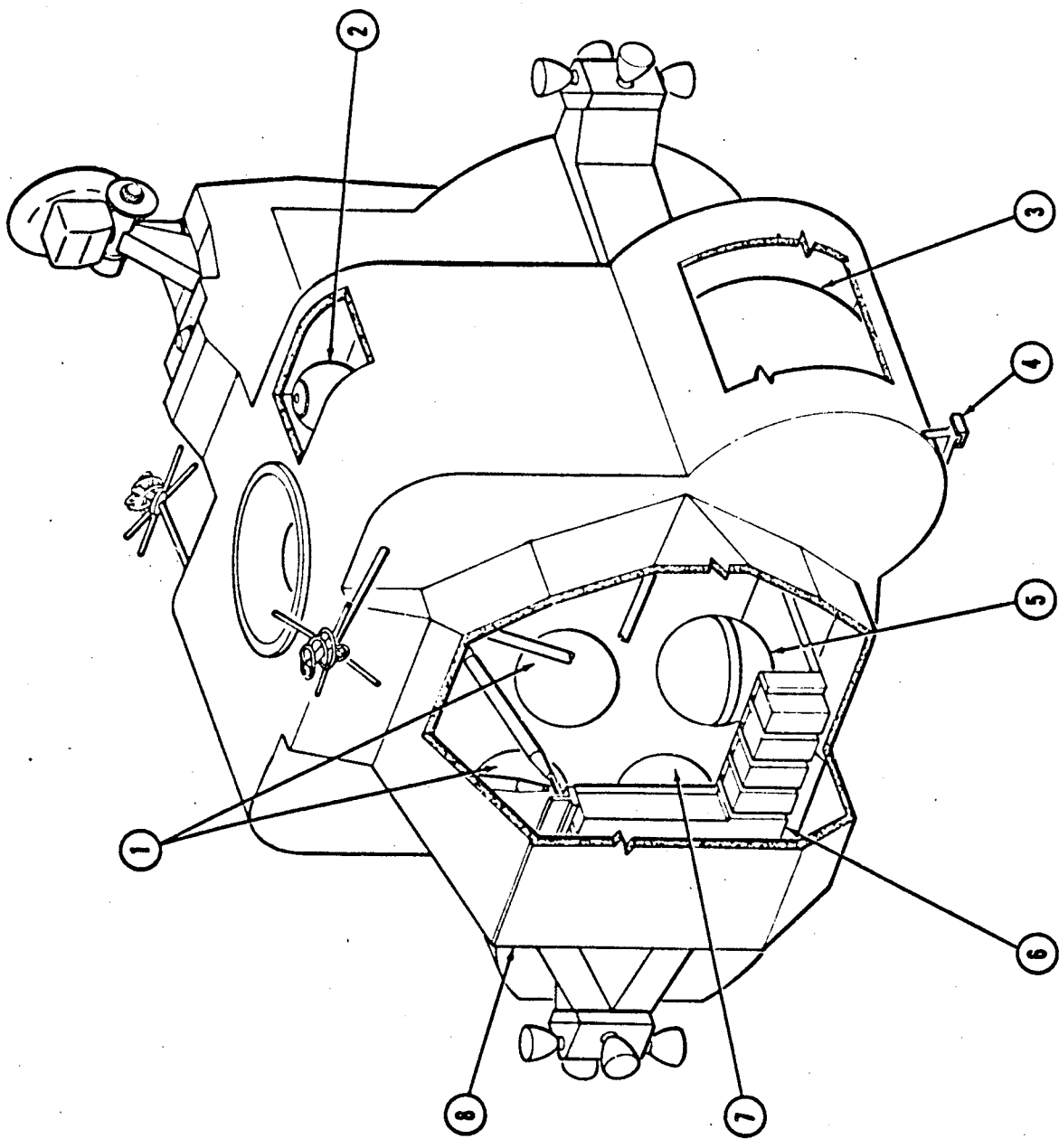

- 1. GASEOUS OXYGEN TANKS
- 2. WATER TANKS (2)
- 3. OXIDIZER TANK
- 4. AFT INTERSTAGE FITTING (2)
- 5. HELIUM TANK

- 6. ELECTRONIC REPLACEABLE ASSEMBLY
- 7. HELIUM TANK
- 8. AFT EQUIPMENT BAY

Figure 2-3. Ascent Stage (Sheet 2 of 2)

2-7. AFT EQUIPMENT BAY.

The aft equipment bay, aft of the midsection pressure-tight bulkhead, is unpressurized, has an equipment rack with integral cold plates on which electronic replaceable assemblies (ERA's) are mounted, and houses two gaseous oxygen (GOX) tanks for the ECS (which provides oxygen for breathing), two helium tanks for ascent stage main propellant pressurization, inverters, and batteries for the Electrical Power Subsystem (EPS).

2-8. TANK SECTIONS.

The propellant tank sections are on either side of the midsection outside the pressurized area. The tank sections contain the ascent engine fuel and oxidizer tanks and the Reaction Control Subsystem (RCS) fuel, oxidizer, and helium tanks. The oxidizer tank which has the greater content and is therefore heavier by 1.6 to 1, is closer to the LEM centerline (X-axis) than is the fuel tank. This provides proper weight distribution at launch and minimizes the center-of-gravity shift due to propellant depletion. Two ECS water tanks are in the overhead of the ascent stage, and two gaseous oxygen storage tanks are in the aft equipment bay.

2-9. WINDOWS.

Two triangular cabin windows in the front-face bulkhead of the forward cabin section (crew compartment) provide visibility during the descent transfer orbit, lunar landing, lunar stay and the rendezvous phases of the LEM mission. Both windows have approximately 2 square feet of viewing area and are canted down to the side to permit adequate peripheral and downward visibility. Each window consists of two panes separated from each other and vented to space environment. The outer pane is thermal and radiation-protective (Vycor) glass; the inner pane is strong, flexible (Chemcor) glass. A clamp-type seal consisting of a Teflon TFE jacket surrounding a metallic spring seals the inner pane.

An overhead window on the left side of the forward cabin section, directly over the Commander's head provides visibility to the Commander during docking. The construction of this window is similar to that of the cabin windows. The overhead window contains a sighting reticule as an aid in lining up the CSM with the LEM. The field-of-view is at least $\pm 10^\circ$ each side of the window centerline in the Y direction and -5° and $+40^\circ$ from the vertical in the Z direction. Visibility is obtained by the Commander leaning backward and looking up from his normal duty station. The approximate visible opening of the window is 5 inches wide in the Y-axis and 12 inches long in the Z-axis. The eye position for the window is as follows: X = 280.63 inches from the base line or ground line of the LEM, Y = 22.00 inches from the LEM centerline, and Z = 37.75 inches from the center of gravity of the LEM.

2-10. HATCHES.

Two hatches in the ascent stage permit the astronauts to leave and enter the LEM. The upper (docking) hatch is used mainly for docking. It is in the midsection on the +X axis, directly above the ascent engine cover. Three steps in the hatch permit use of the hatch for observation while on the lunar surface. The ingress/egress forward hatch is on the +Z axis, beneath the center instrument console (in the forward cabin section) and is used to leave and enter on the lunar surface. Each hatch contains a dump valve and a manually-operated single detent mechanism that preloads the hatch against its seal.

Each hatch is sealed with a preloaded silicone elastomeric compound seal mounted in the LEM structure. When the latch is closed, a lip near the outer circumference of hatch enters the seal, ensuring a pressure-tight contact. Both hatches open into the LEM; normal cabin pressurization forces the hatches into the seals. To open either hatch it is necessary to depressurize the cabin through the dump valve; then unfasten the latch and open the hatch. The forward hatch has an external platform on which the astronauts step after leaving and before entering the LEM.

2-11. DESCENT STAGE. (See figure 2-4.)

The descent stage is the unmanned portion of the LEM. It consists of that equipment necessary for landing on the lunar surface and serves as a platform for launching the ascent stage after completion of the lunar stay. In addition to the descent engine and its related components, the descent stage houses the scientific equipment; and tanks for water and oxygen used by the ECS, four batteries (for the EPS) located in the battery storage bay and six spare portable life support systems (PLSS) batteries. The landing gear is attached externally to the descent stage.

The descent stage is constructed of aluminum alloy; chem-milling is used extensively to reduce weight. The inner structural skin is surrounded with a composite layer of insulation and a thin aluminum-alloy skin that forms a modified octagonal shape around the descent stage and thermally protects and isolates the structure. Two pairs of transverse beams arranged in a cruciform, together with an upper and

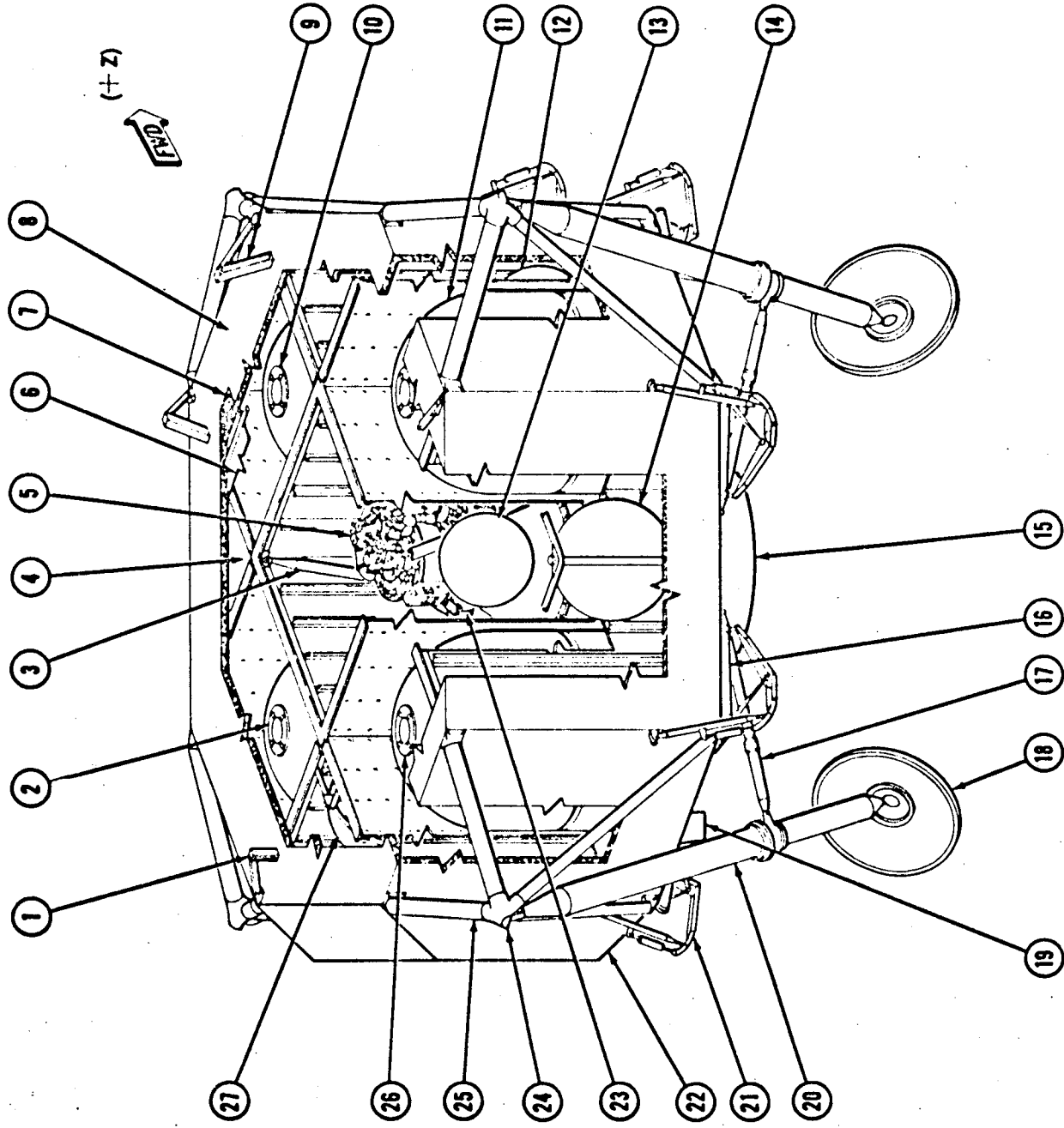

1. AFT INTERSTAGE FITTING
2. FUEL TANK
3. ENGINE MOUNT
4. PLSS, S-BAND ANTENNA STORAGE BAY
5. DESCENT ENGINE
6. STRUCTURAL SKIN
7. INSULATION
8. THERMAL SHIELD
9. FORWARD INTERSTAGE FITTING
10. OXIDIZER TANK
11. FUEL TANK
12. BATTERY STORAGE BAY
13. OXYGEN TANK

14. HELIUM TANK/CRYOGENIC
15. DESCENT ENGINE SKIRT
16. TRUSS ASSEMBLY (LDG GR)
17. SECONDARY STRUT (LDG GR)
18. PAD (LDG GR)
19. LANDING RADAR ANTENNA
20. PRIMARY STRUT (LDG GR)
21. LOCK ASSEMBLY (LDG GR)
22. SCIENTIFIC EQUIPMENT BAY
23. GIMBAL RING
24. ADAPTER ATTACHMENT POINT
25. OUTTRIGGER
26. OXIDIZER TANK
27. WATER TANK

NOTE:
LANDING GEAR SHOWN IN
RETRACTED POSITION

Figure 2-4. Descent Stage

15 October 1965

lower deck and end closure bulkheads, provide the main support structure. The beams are of conventional skin-and-stringer construction. All joints are fastened with standard mechanical fasteners. The space between the intersections of the beams forms the center compartment, which contains the descent engine. Outriggers that extend from the end of each of the two pairs of beams provide support and attachment for the landing gear legs. Four main propellant tanks surround the engine: two oxidizer tanks between the Z-axis beams; two fuel tanks between the Y-axis beams. The scientific equipment, helium, oxygen, and water tanks; the lunar surface antennas; EPS batteries; and PLSS batteries are in the diagonal bays, which are adjacent to the propellant tanks.

2-12. LANDING GEAR.

The landing gear (figure 2-4) is of the cantilever type. It consists of four sets of legs connected to outriggers that extend from the ends of the descent stage structural beams. The legs extend from the front, rear, and sides of the LEM. Each landing gear leg consists of a primary strut and footpad, a drive-out mechanism, two secondary struts, two downlock mechanisms, and a truss. All struts have crushable attenuator inserts. The primary struts absorb compression loads; the secondary struts, compression and tension loads. The forward landing gear (+Z axis) has a boarding ladder on the primary strut, which is used to climb from and to the ascent stage ingress/egress hatch.

At launch, the landing gear is stowed in a retracted position; it remains retracted until shortly after the astronauts enter the LEM during lunar orbit. The landing gear uplocks are then explosively released and springs in each driveout mechanism extend the landing gear. Once extended, each landing gear is locked in place by the two downlock mechanisms in each landing gear.

2-13. INTERSTAGE ATTACHMENTS, UMBILICALS, AND SEPARATIONS.

At earth launch, the LEM is within the spacecraft LEM adapter (SLA) between the Service module and the S-IVB booster (figure 2-5). The SLA has an upper and lower section. The outriggers to which the landing gear is attached provide for attachment of the LEM to the lower section of the SLA at their apex. Before transposition, the upper section of the SLA is explosively separated into four segments. These segments, which are hinged to the lower section, fold back. After transposition, the lower section is released, separating the SLA and the booster from the LEM. Four explosive nuts and bolts connect the ascent and descent stages. At lunar launch, or for abort before lunar landing, the two stages are separated by firing these nuts and bolts. Interstage wiring umbilicals are explosively disconnected and hardlines are mechanically disconnected at stage separation.

2-14. ELECTRO-EXPLOSIVE DEVICES.

Electroexplosive devices (EED) are used to release the landing gear for deployment, to enable helium pressurization of the Ascent and Descent Propulsion Subsystem, and Reaction Control Subsystem, and for stage separation. The electroexplosive devices are exploded by an Apollo Standard initiator, controlled by its respective switch on the Explosive Devices Panel. More detailed information for the EED subsystem is provided in Section III.

LMA790-1

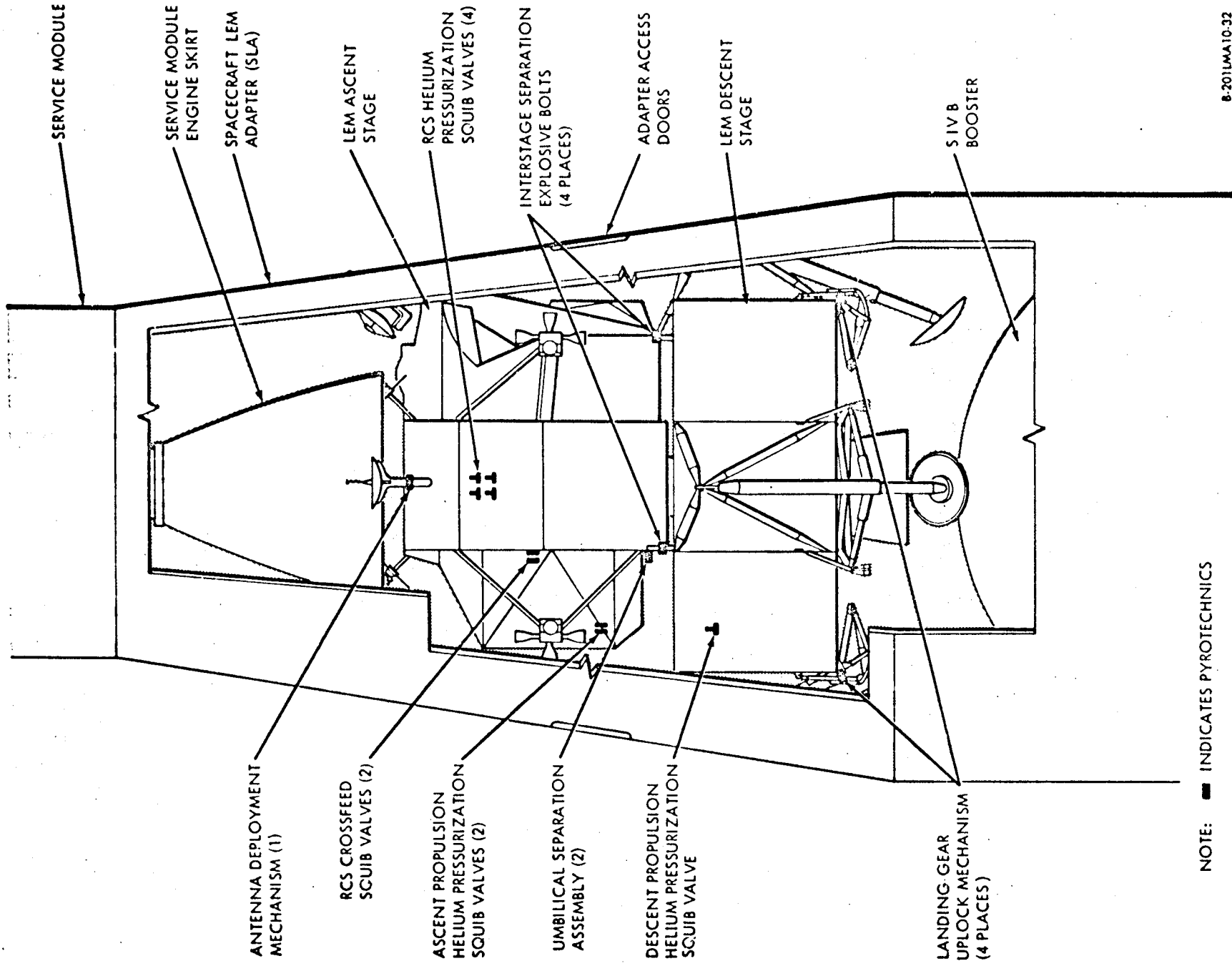

NOTE: ■ INDICATES PYROTECHNICS

8-2011LMA10-32

Figure 2-5. LEM Interface and Explosive Devices Location

15 October 1965

2-9/2-10

SECTION III OPERATIONAL SUBSYSTEMS

3-1. GENERAL.

This section describes the LEM operational subsystems in sufficient detail to convey an understanding of the LEM as an integrated system. The integrated LEM system comprises the following subsystems:

- Guidance, Navigation, and Control
- Reaction Control
- Propulsion
- Instrumentation
- Communications
- Electrical Power
- Environmental Control
- Crew Provisions
- Electroexplosive Devices

Each subsystem is functionally related to one or more of the other subsystems. This section also describes the LEM displays and controls that are related to all operational subsystems.

3-2. COMMANDER'S DISPLAYS AND CONTROLS. (See figures 3-1 and 3-2.)

The displays and controls provide the astronauts with information and instantaneous control of the LEM subsystems to complete the mission successfully, or to return the LEM safely to the CSM in an emergency.

The placement of displays and controls is such that astronaut safety and mission success are optimized. Displays and controls required for LEM-management by a single astronaut are centrally located, accessible to both astronauts. Each astronaut is assigned specific responsibilities. Certain displays and controls are duplicated at each flight station to provide reliability backup.

3-3. COMMANDER'S UPPER SIDE CONSOLE.

The Commander's upper side console consists of circuit breaker panels that have circuit breakers for the Environmental Control Subsystems (ECS); Reaction Control Subsystem (RCS); Guidance, Navigation, and Control (GN & C) Subsystem; Propulsion Subsystem; Communications Subsystem; Electrical Power Subsystem (EPS); Instrumentation Subsystem; and Explosive Devices Subsystem.

3-4. COMMANDER'S CENTER SIDE CONSOLE.

The controls previously located on the Commander's center side console (such as the power distribution panel and audio control panel) have been relocated to other console areas; at present there are no displays or control panels planned for location on this console.

3-5. COMMANDER'S LOWER SIDE CONSOLE.

The Commander's lower side console consists of an explosive devices panel and an audio panels.

3-6. Explosive Devices Panel. The controls of the explosive-devices panel are used to release the landing gear for deployment; to enable helium pressurization of the Ascent Propulsion, Descent Propulsion, or Reaction Control Subsystems; to open the Environmental Control Subsystem (ECS) water feed valve; and for stage separation. The electro-explosive devices used are exploded by a standard Apollo initiator, each controlled by its respective switch on the explosive devices panel.

3-7. Audio Panel. The controls of the audio panel enable the audio center to receive S-band and vhf/am voice transmission and route microphone amplifier outputs for transmission via S-band and vhf/am equipment. The controls also enable reception and transmission of voice via the intercom system, providing a voice conference capability between the extravehicular astronaut and the astronaut in the LEM.

3-8. COMMANDER'S LIGHTING PANEL.

The Commander's lighting panel controls the brightness of the annunciators in the caution/warning lights array of the component caution lights, the electroluminescence of the numeric readouts, the low-level electroluminescence integrally-illuminated markings and displays, the Commander's side console lights, and the floodlights.

3-9. BOTTOM CENTER PANEL.

The bottom center panel consists of the primary guidance and navigation panel which permits the astronauts to load information into the LEM guidance computer (LGC), initiate program functions and perform tests of the LGC and other portions of the GN & C Subsystem. In addition to failures in the LGC, the panel displays indicate program functions being executed by the LGC and specific data selected by the keyboard input. This data is also routed from the LGC to the inertial measurement unit (IMU) and the LEM. Commands for switching to different modes are supplied to the IMU, and data is supplied to the Spacecraft Telemetry System for routing to Manned Space Flight Network (MSFN). In conjunction with the LGC, the panel supplies indications to the caution/warning lights array.

3-10. LOWER CENTER PANEL.

The lower center panel consists of the radar panel, stabilization and control panel, heater control panel, and lighting panel.

3-11. Radar Panel. The controls of the radar panel operate the rendezvous radar antenna in the manual or automatic mode, determine the landing radar antenna position with respect to the LEM X-axis, provide signals to the rendezvous and landing radar test circuitry, and provide power to the landing radar subsystem.

3-12. Stabilization and Control Panel. The controls of the stabilization and control panel permits selection of four modes of attitude control provided by the control electronics section of the GN & C Subsystem. The automatic mode provides fully-automatic attitude control. The attitude hold mode is the primary attitude control mode for the final approaching, landing, and docking phases of the mission. The pulse mode is an open-loop attitude control mode. In the pulse mode, minimum-impulse attitude changes can be made in any axis with the attitude controller. The direct mode is also an open-loop attitude control mode; it provides full RCS jet thrusting for attitude changes in all three axes.

3-13. Heater Control Panel. The heater control panel controls the defogging heaters for the Commander's and Systems Engineer's forward windows and the Commander's overhead window, the temperature of the four RCS quadrants, the temperature range for automatic heating of the radar antennas, and the heater assemblies of the radar systems. The temperature indicator displays the temperature, in degrees Fahrenheit, of the radar assembly or of any one of the RCS quadrants.

3-14. Lighting Panel. The lighting panel controls the brightness of the dome light, docking and tracking lights and the Systems Engineer's side console lights, and testing of the lamps.

3-15. COMMANDER'S CENTER PANEL.

3-16. Flight Control. The controls and displays related to flight control are as follows: flight director attitude indicator, rate/error monitor switch, attitude monitor switch, forward velocity/lateral velocity - LOS azimuth rate/LOS elevation rate indicator, mode select switch, shaft/trunnion switch, ΔV indicator, ΔV reset switch, elapsed timer, event timer indicator, thrust indicator, altitude/range indicator, thrust/weight indicator, guidance control switch, and altitude/range monitor switch.

The flight director attitude indicator displays total attitude, attitude rates, and attitude errors, or attitude, attitude rates, and rendezvous radar shaft and trunnion angles, depending upon the setting of the rate/error monitor switch. Setting the attitude monitor switch selects either Primary Guidance Navigation Subsystem (PGNS) or Abort Guidance System (AGS) as the source of attitude and attitude errors displayed on the flight director attitude indicator. The shaft and trunnion angles are displayed by the pitch and yaw error needles, respectively, when the rate/error monitor switch is set to RNDZ RADAR. The roll rate indicator, pitch rate indicator, and yaw rate indicator are, respectively, directly above, to the right, and directly below the flight director attitude indicator. The attitude rate information displayed on the roll, pitch, and yaw indicators is always obtained from the crew equipment system (CES) rate gyro.

The forward velocity/lateral velocity - LOS azimuth rate/LOS elevation rate indicator is used in conjunction with the rate/error monitor switch. Forward and lateral velocities are coincident with LEM Z- and Y-axis velocities when the source driving the display is the PGNS. When the landing radar is

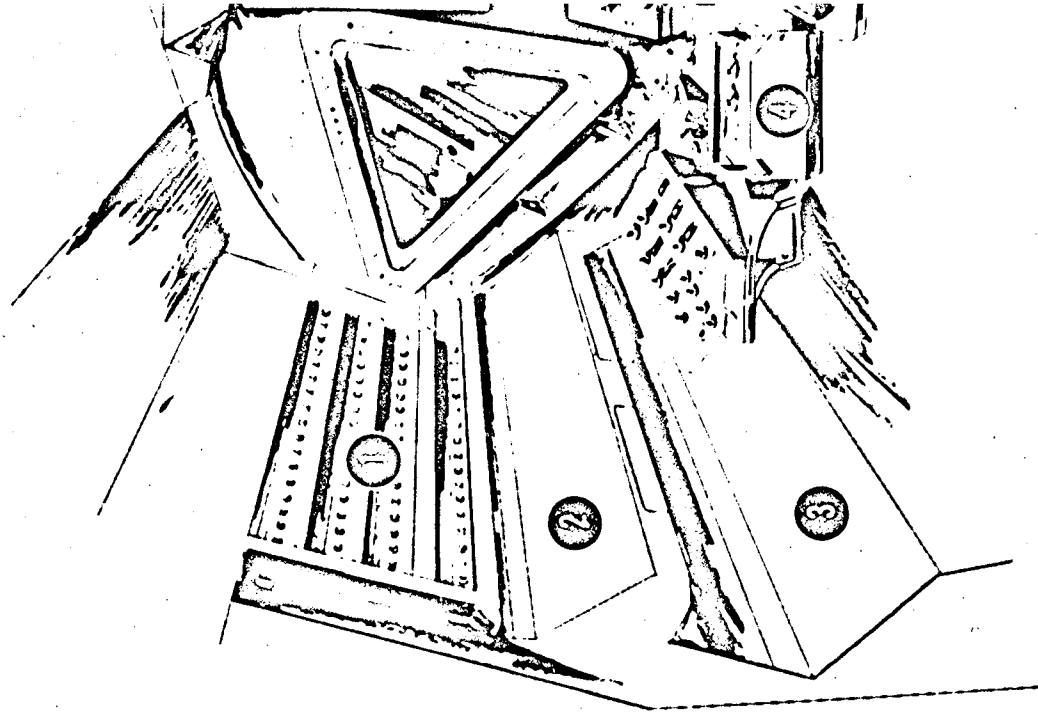

- ① COMMANDER'S UPPER SIDE CONSOLE
 - CIRCUIT BREAKER PANEL
- ② COMMANDER'S CENTER SIDE CONSOLE
 - COMMANDER'S LOWER SIDE CONSOLE
 - EXPLOSIVE DEVICES PANEL
 - AUDIO PANEL
- ③ COMMANDER'S LIGHTING PANEL
- ④
- ⑤
- ⑥
- ⑦

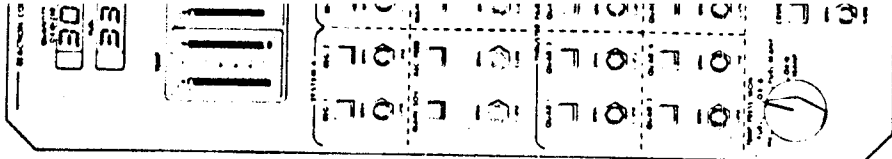
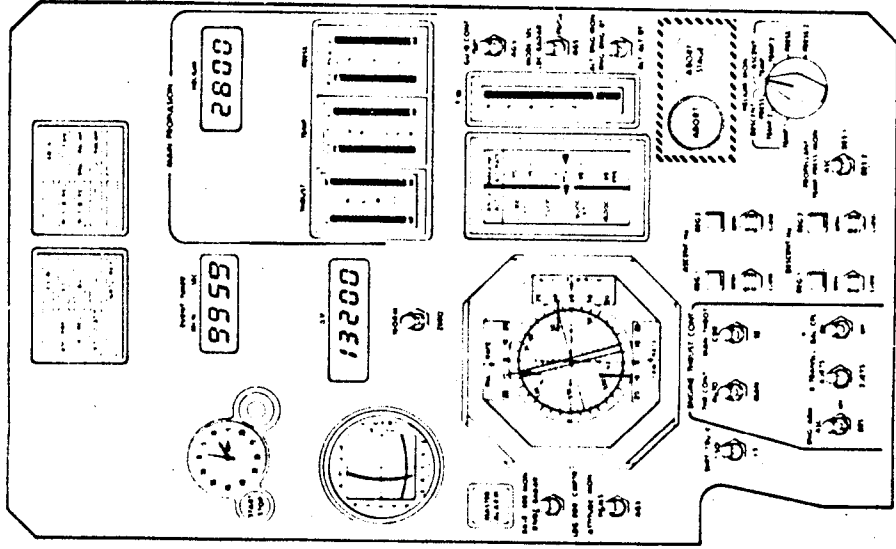
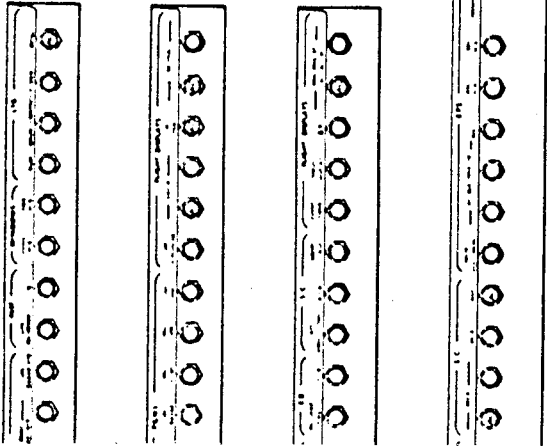

11

12

13

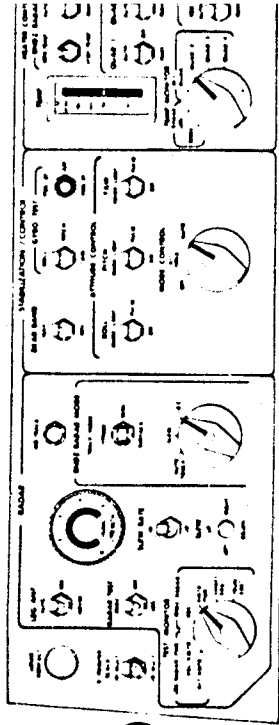
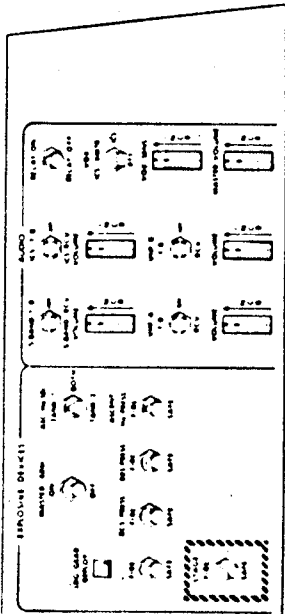

16

19

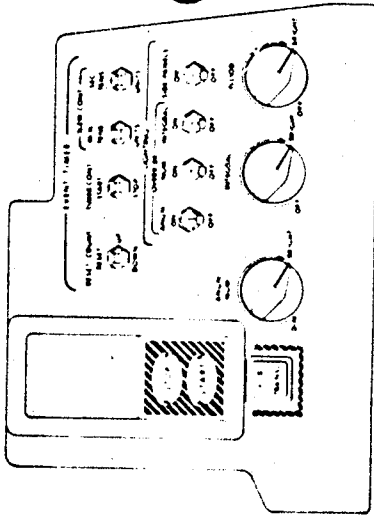

ENGINEER'S LOWER SIDE
 COMMUNICATIONS PANEL
 COMMUNICATIONS ANTENNAS

14

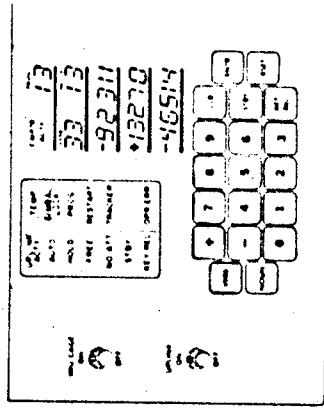

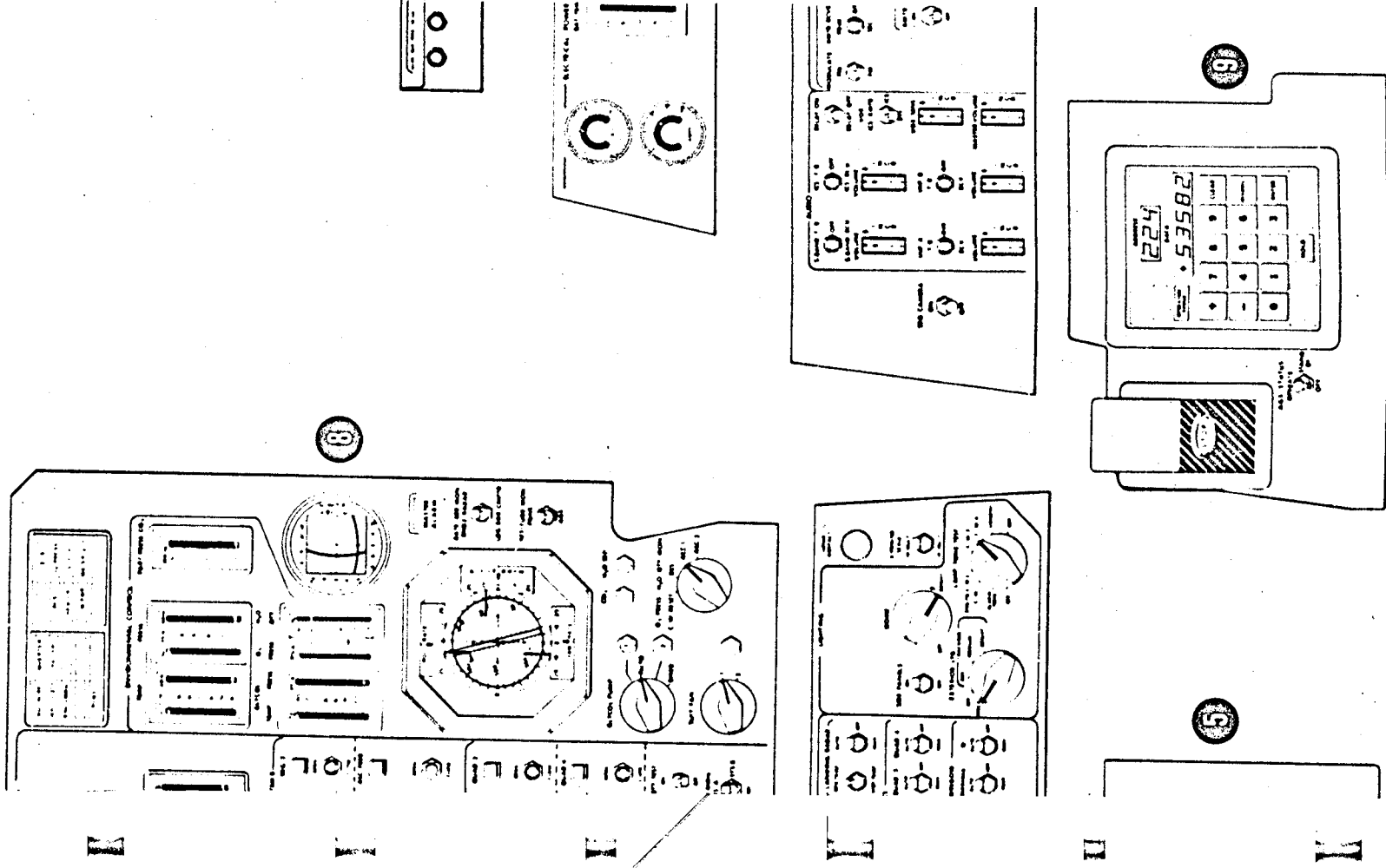
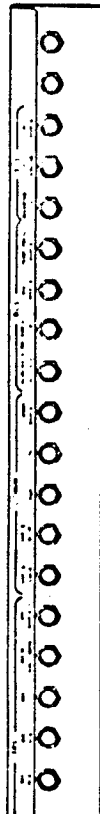
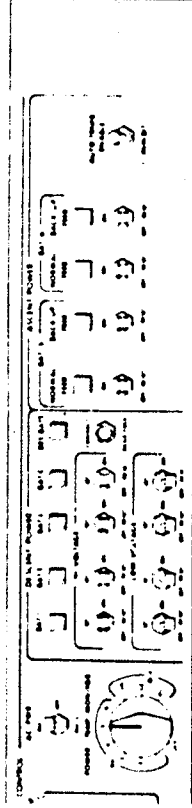

Figure 3-

15 October 1965



10



11

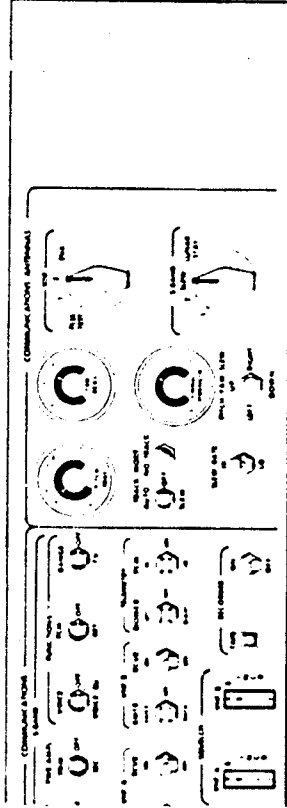

12

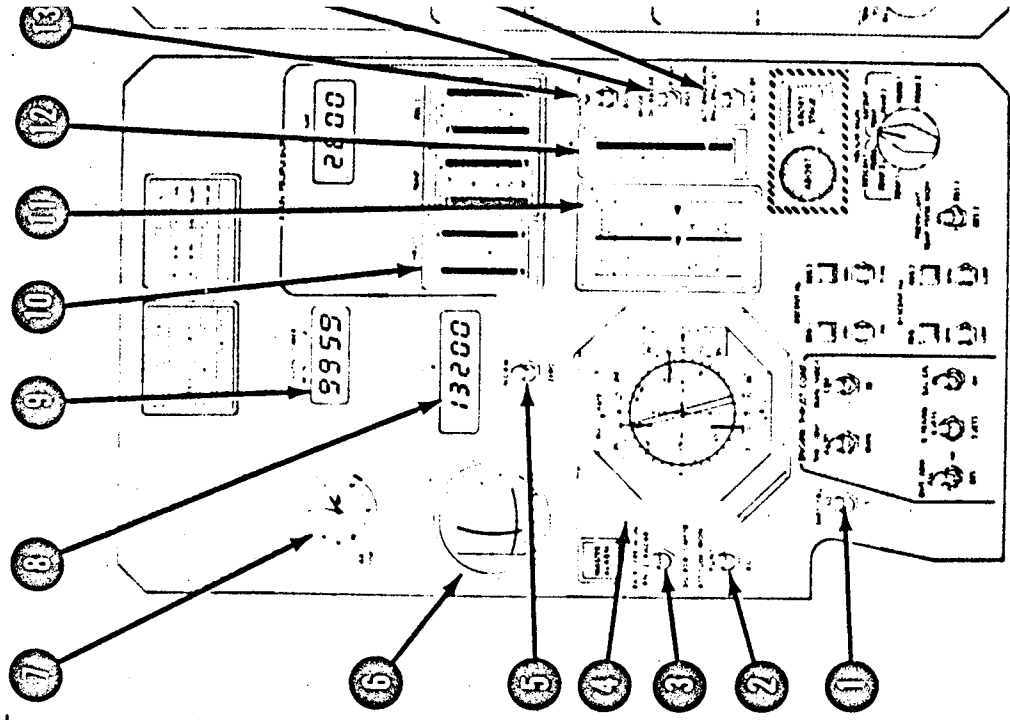

FLIGHT COI

- | | |
|--|-----|
| 1. SHAFT/TRUNION SWITCH | 12. |
| 2. COMMANDER'S ATTITUDE MONITOR SWITCH | 13. |
| 3. COMMANDER'S RATE/ERROR MONITOR SWITCH | 14. |
| 4. COMMANDER'S FLIGHT DIRECTOR ATTITUDE INDICATOR | 15. |
| 5. V RESET SWITCH | 16. |
| 6. COMMANDER'S FORWARD VELOCITY/LATERAL VELOCITY—LOS AZIMUTH RATE/LOS ELEVATION RATE INDICATOR | 17. |
| 7. ELAPSED TIMER | 18. |
| 8. V INDICATOR | 19. |
| 9. EVENT TIMER INDICATOR | |
| 10. THRUST INDICATOR | |
| 11. ALTITUDE/RANGE INDICATOR | |

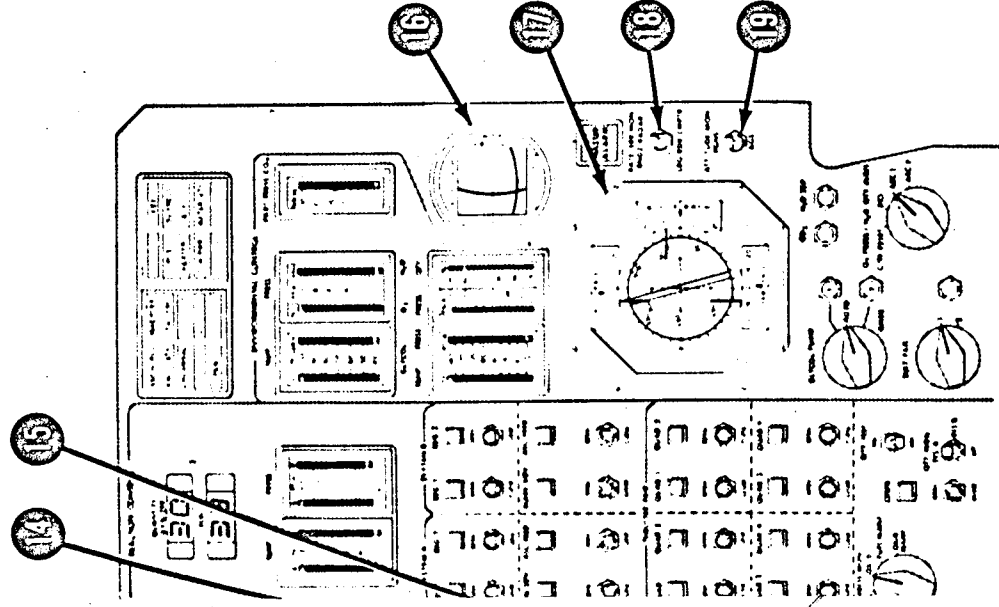

NTROL

- THRUST/WEIGHT INDICATOR
- GUIDANCE CONTROL SWITCH
- MODE SELECT SWITCH
- ALTITUDE/RANGE MONITOR SWITCH
- SYSTEMS ENGINEER'S FORWARD VELOCITY/LATERAL VELOCITY—LOS
- AZIMUTH RATE/LOS ELEVATION RATE INDICATOR
- SYSTEMS ENGINEER'S FLIGHT DIRECTOR ATTITUDE INDICATOR
- SYSTEMS ENGINEER'S RATE/ERROR MONITOR SWITCH
- SYSTEMS ENGINEER'S ATTITUDE MONITOR SWITCH

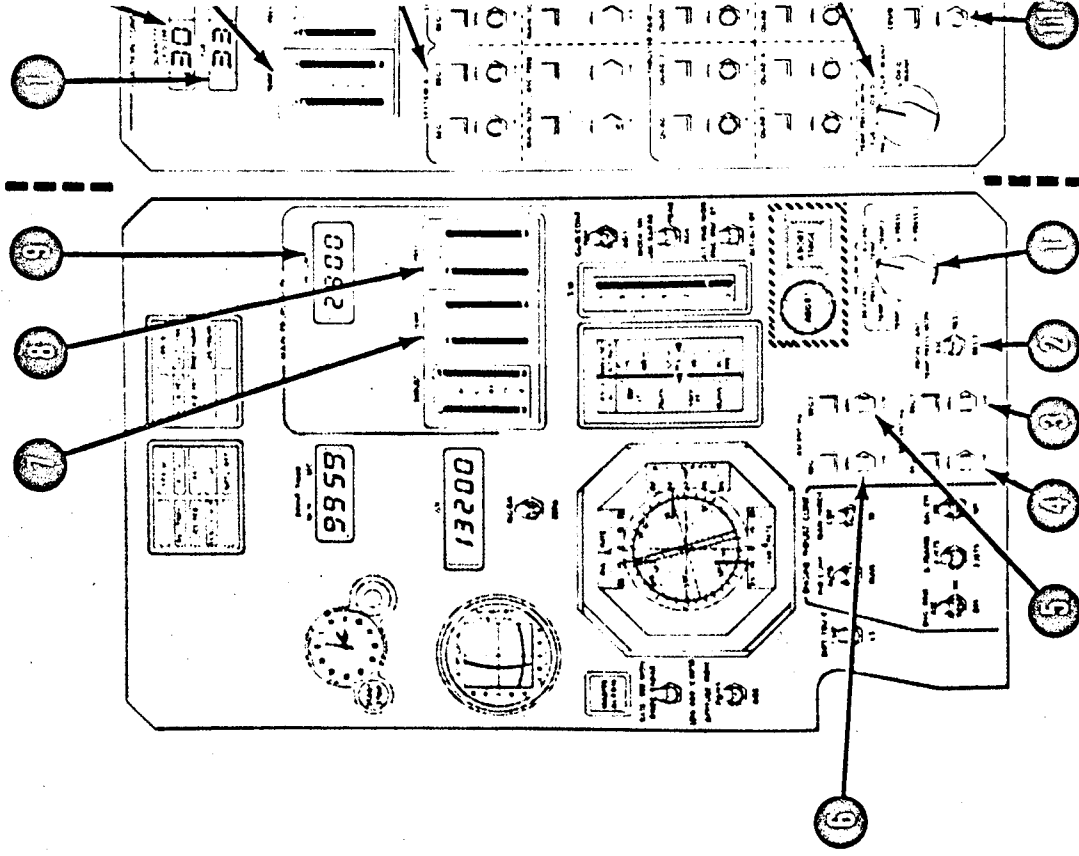

MAIN PROPULSION

- 1. HELIUM MONITOR SELECT SWITCH
- 2. PROPELLANT TEMPERATURE/PRESSURE MONITOR SWITCH
- 3. DESCENT HELIUM REGULATOR = 2 SWITCH
- 4. DESCENT HELIUM REGULATOR = 1 SWITCH
- 5. ASCENT HELIUM REGULATOR = 2 SWITCH
- 6. ASCENT HELIUM REGULATOR = 1 SWITCH
- 7. PROPELLANT TEMPERATURE INDICATOR
- 8. PROPELLANT PRESSURE INDICATOR
- 9. HELIUM INDICATOR

REAC

- 1. FUEL QU.
- 2. OXIDIZER
- 3. TEMPERA
- 4. PRESSUR
- 5. SYSTEM I
- 6. SYSTEM I
- 7. THRUSTEI
- 8. FLAGS
- 9. TEMPERA
- 10. SELECT S
- 11. QUANTITY
- 12. QUANTITY
- 13. CROSSFEE

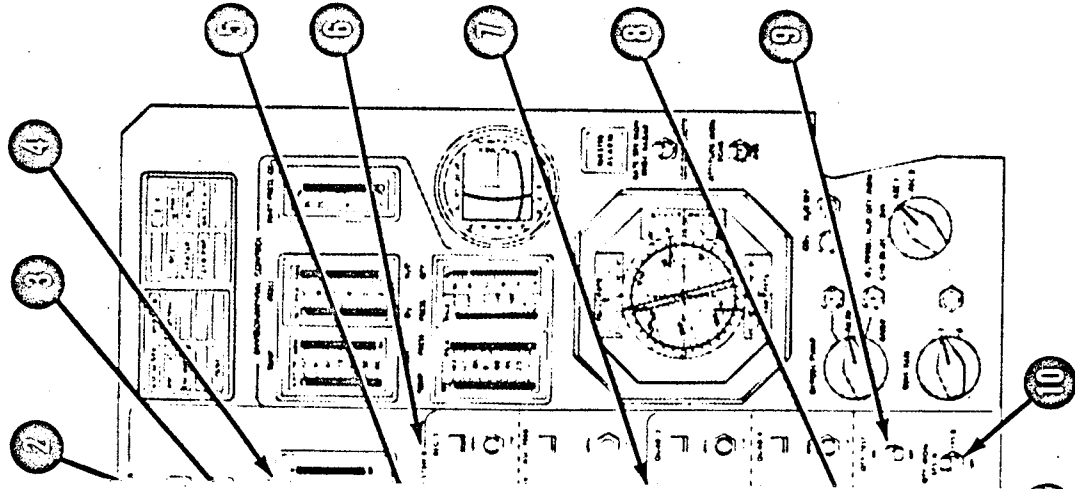

ENVIRONMENTAL CONTROL

- 1. ANTIMONY INDICATOR
- 2. QUANTITY INDICATOR
- 3. TEMPERATURE INDICATOR
- 4. TEMPERATURE INDICATOR
- 5. SWITCHES AND STATUS FLAGS
- 6. SWITCHES AND STATUS FLAGS
- 7. SWITCHES AND STATUS
- 8. TEMPERATURE/PRESSURE MONITOR SWITCH
- 9. TEST SWITCH
- 10. MONITOR SWITCH
- 11. MONITOR SWITCH AND STATUS FLAG

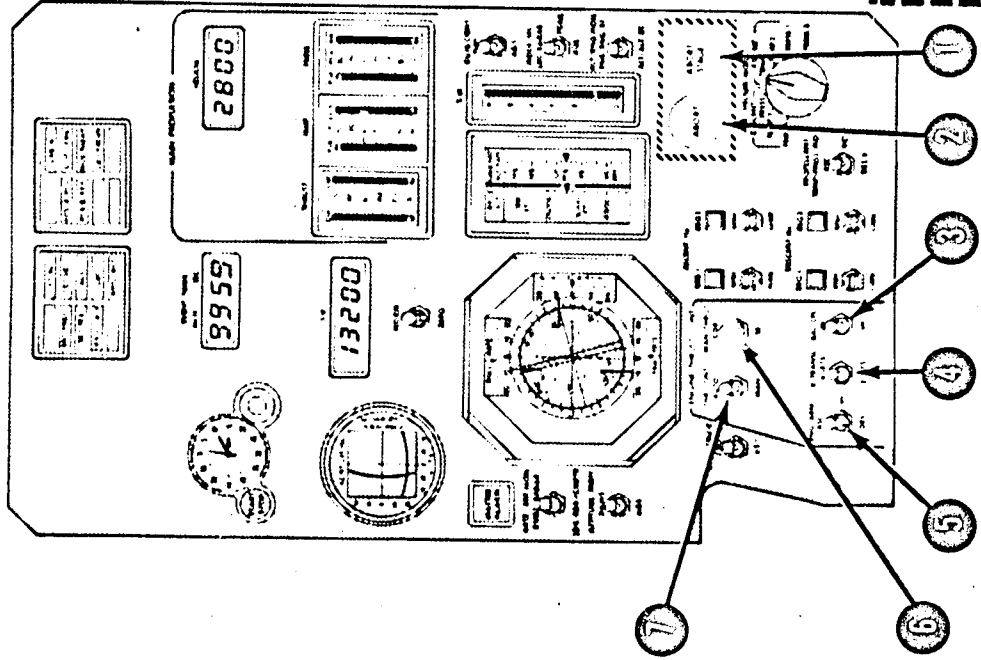

ENGINE THRUST CONTROL

- 1. ABORT STAGE SWITCH
- 2. ABORT SWITCH
- 3. BALANCED COUPLES SWITCH
- 4. X-TRANSLATION SWITCH
- 5. ENGINE ARM SWITCH
- 6. MANUAL THROTTLE SWITCH
- 7. THRUST CONTROL SWITCH

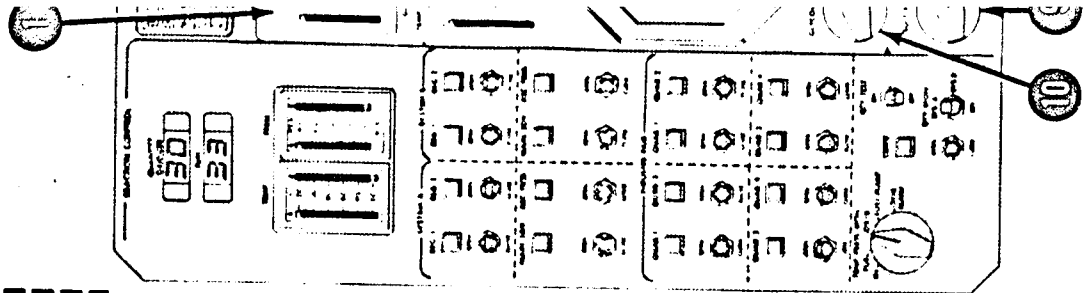

ENVIRONMENTAL CONTROL

- 1. SUIT/CABIN TEMPERATURE INDICATOR
- 2. SUIT/CABIN PRESSURE INDICATOR
- 3. PARTIAL PRESSURE INDICATOR
- 4. GLYCOL TEMPERATURE INDICATOR
- 5. O₂ PRESSURE/H₂O PRESSURE INDICATOR
- 6. CO₂ PARTIAL PRESSURE INDICATOR
- 7. H₂O SEPARATOR LIGHT
- 8. O₂ PRESSURE/H₂O PRESSURE SWITCH
- 9. SUIT FAN SELECT SWITCH
- 10. GLYCOL PUMP SELECT SWITCH

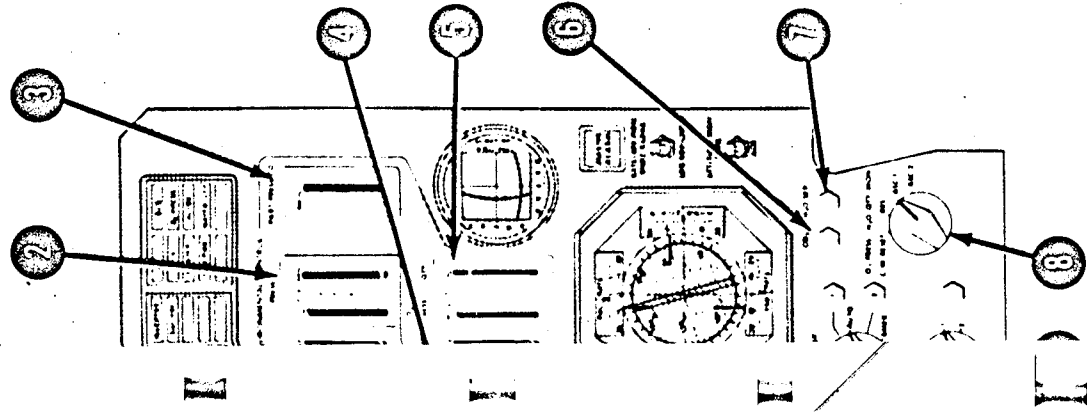

**MENTAL
ROL**

- 1. TEMPERATURE INDICATOR
- 2. OIL PRESSURE INDICATOR
- 3. OIL PRESSURE
- 4. QUANTITY INDICATOR
- 5. FIRE LIGHT
- 6. QUANTITY MONITOR
- 7. PITCH
- 8. T SWITCH

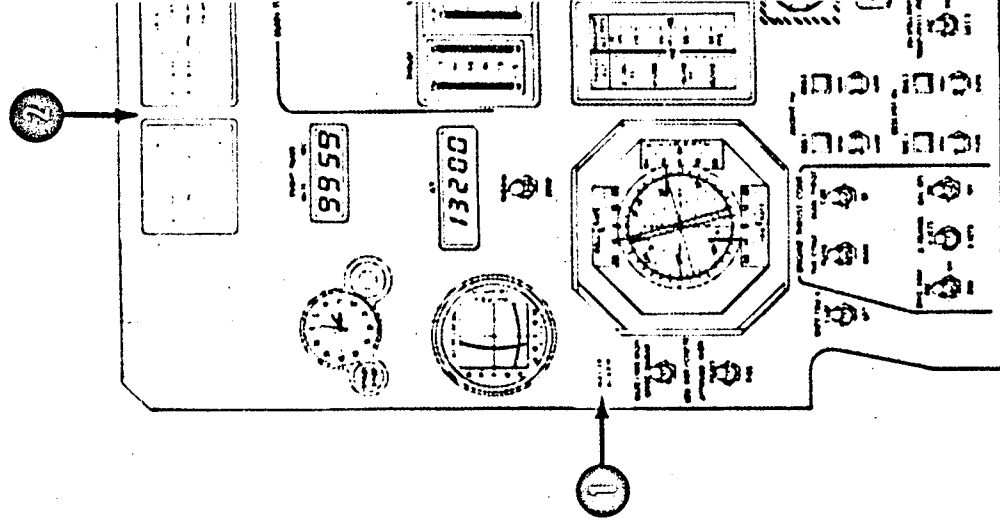

CAUTION

- 1. COMM/LIGHT
- 2. WARN/CAUTION
- 3. SYSTEM
- 4. SWITCH

Figure 3-2. Commander

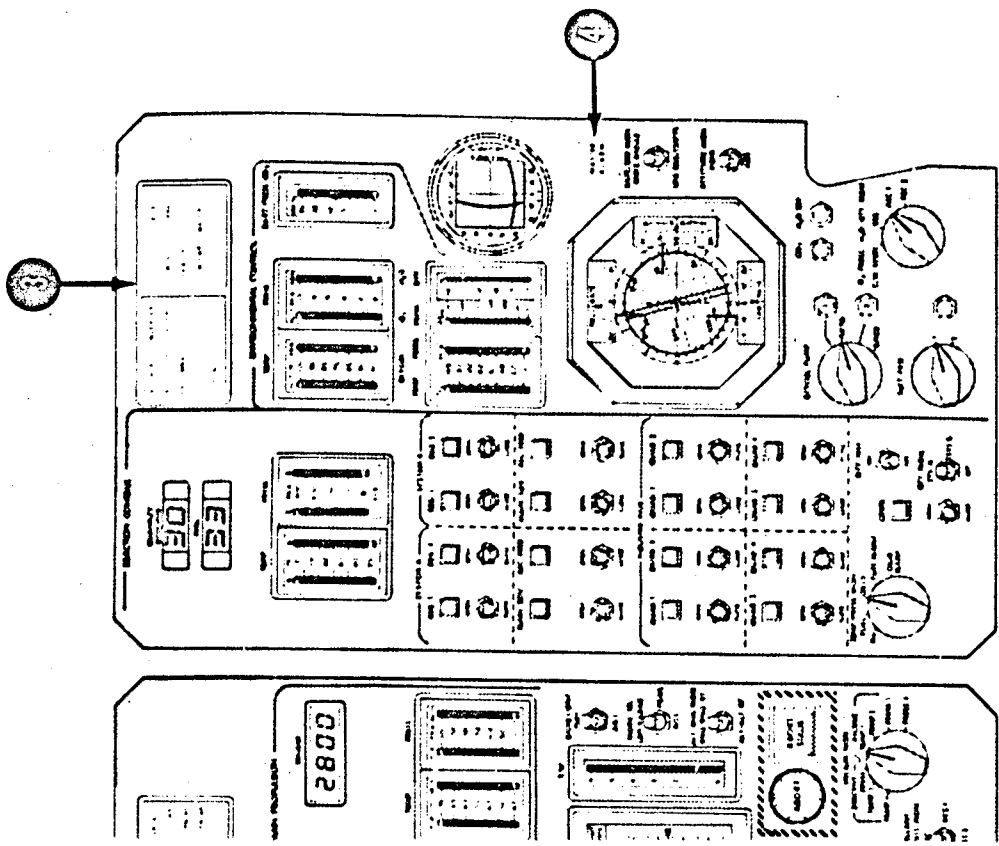

3 and 4 WARNING LIGHTS

- 3 COMMANDER'S MASTER ALARM SWITCH
- 4 WARNING LIGHTS
- 5 POSITION LIGHTS
- 6 TEMS ENGINEER'S MASTER ALARM
- 7 TOUCH LIGHT

A-201LMA10-52

the driving source, the forward and lateral velocities are coincident with LEM Z- and Y-axis velocities only when the radar beams are coincident with the LEM body axis (from the low-gate point to touchdown). When the AGS system is the driving source, lateral velocity is the only information displayed and is coincident with Y-axis velocity.

The elapsed timer displays time (up to 60 hours) in hours, minutes, and seconds; it is controlled by the elapsed timer start/stop pushbutton and the elapsed timer set switch. The event timer indicator displays time in minutes and seconds. It can count up from zero to 59 minutes and 59 seconds, or from 59 minutes and 59 seconds down to zero.

The ΔV indicator provides a five-digit readout of changes in vehicle velocity (feet per second) during those phases of the mission involving changes of velocity. The indicator displays the time-integrated X-axis acceleration obtained from the AGS. It may be used to provide a gross check of engine performance, because any given throttle setting provides a specific display value after a given time interval for a given LEM mass. It may also be used in certain abort situations when a thrust attitude profile is to be followed. The ΔV reset switch controls the inputs to the ΔV indicator.

The attitude/range indicator displays either range/rate information or altitude/altitude rate information, as selected with the attitude/range monitor switch. The altitude/altitude rate information is obtained from the landing radar, the PGNS, or the AGS, as selected with the mode select switch. When landing radar information is selected, true altitude and altitude rate data are available from the low-gate point to touchdown if the LEM X-axis is vertical. Before reaching the low-gate point, only true altitude data is available from the landing radar. When PGNS or AGS is selected with the mode select switch, inertially derived altitude and altitude rate data are available for display.

The thrust/weight indicator is a self-contained accelerometer that displays instantaneous X-axis acceleration in lunar g units ($1g = 5.32 \text{ ft/sec}^2$). The indicator may be used to provide a gross check of engine performance, because given throttle setting provides a specific acceleration for a given LEM mass.

The thrust indicator is a dual vertical meter (0% to 100% thrust) whose left needle displays descent engine chamber pressure and whose right needle displays either manual thrust commands initiated with the Systems Engineer's or Commander's thrust/translation controller or LGC thrust commands, as selected with the thrust control switch. Both needles are aligned at the same scale reading under normal operation. A divergence between needle settings indicates a malfunction or that manual thrust authority is being introduced to enable a smooth transition to fully manual control. When the manual thrust authority is introduced, the thrust control switch is set to MAN when the thrust command needle (right needle) reaches 10% thrust. After setting the switch to MAN, manual thrust commands are displayed by the right needle and both needles should then be aligned.

3-17. Warning Lights. The warning lights provide a red indication to warn of a malfunction that affects astronaut safety and requires immediate action to counter the emergency. If a warning light lights, the astronauts can alleviate the condition indicated. Lighting of a warning light is accompanied by a tone in the astronaut's headset. Information concerning the malfunction is simultaneously telemeasured to the ground monitoring station to ensure control station awareness of the situation in the LEM. The MASTER ALARM switch-light on the Commander's center panel and on the Systems Engineer's center panel provide a red indication when a warning or caution light goes on. Both master alarm switch-lights are extinguished and the tone silenced by pressing either master alarm switch-light. Each warning light is extinguished only by a signal from the sensor at the malfunction, indicating restoration of a normal or within-tolerance condition.

3-18. Main Propulsion. The controls and displays related to main propulsion are as follows: propellant temperature indicator, propellant pressure indicator, helium indicator, propellant temperature/pressure monitor switch, helium monitor select switch, ascent helium regulator switches, and descent helium regulator switches.

The propellant temperature indicator displays the temperature (degrees Fahrenheit) of the fuel and oxidizer tanks of the ascent or descent propellant system, depending upon the setting of the propellant temperature/pressure monitor switch.

The propellant pressure indicator displays the pressure of the fuel and oxidizer tanks of the ascent or descent propellant system, depending upon the setting of the propellant temperature/pressure monitor switch.

The helium indicator displays the ambient temperature, and pressure, of the ascent or descent helium tank, as selected with the helium monitor selector switch.

The ascent and descent helium regulator switches are center-off, spring-loaded toggle switches that control normally open, latch-type solenoid valves upstream of the helium pressure regulators. A pulse from the ascent or descent switch triggers the applicable solenoid to the open or closed position to regulate pressure from the ascent or descent tanks.

3-19. Engine Thrust Control. The controls and displays related to engine thrust control are as follows: three-axis attitude controller, thrust/translation controller, throttle/jets control select lever, engine arm switch, manual throttle switch, thrust control switch, +X-translation control pushbutton, X-translation switch, balanced couples switch, abort stage switch, abort switch, engine stop switch, engine start switch, and lunar contact light.

The thrust control switch permits switching from automatic throttle control to manual throttle control. In the AUTO position, the LGC command signals are summed with the manual command signals and fed to the computer. In the MAN position, the LGC throttle command signals to the descent engine are interrupted.

The manual throttle switch selects the Commander's or System Engineer's attitude controller that can be used to manually adjust the descent engine thrust level, if its corresponding throttle/jets control select lever is set to THROTTLE. When the manual throttle switch is in the CDR position, only the Commander's attitude controller is enabled to adjust descent engine thrust level; in the SE position, only the Systems Engineer's attitude controller is enabled.

The engine arm switch is a three-position lock toggle switch. The ASC position provides an arming signal that enables firing of the ascent engine and simultaneously signals the LGC that the engine is armed. In the OFF position, the arming signals are removed from the engine valves and the LGC. The DES position arms the descent engine and signals the LGC that the engine is armed. Regardless of the setting of this switch, the appropriate engine is armed if the abort switch or abort stage switch is actuated.

The X-translation switch selects the number of jets to be used in X-axis translation maneuvers. This switch is used only with the AGS systems.

The balanced couples switch selects either balanced pairs of RCS jets in a couple or unbalanced X-axis RCS jets, for use in maintaining pitch and roll attitude during the ascent engine thrust phase when the AGS is in the guidance control loop. This switch is normally set to ON (balanced couples) during the initial phases of lunar ascent, for maximum stabilization over any center-of-gravity thrust vector misalignment. After some minimum burn time (to be determined), when balanced-couple operation is no longer required, this switch can be set to OFF to conserve fuel.

The abort switch is actuated to initiate an abort, using only the descent engine. Actuation of this switch causes the following events to occur: a command signal is sent to arm the descent engine; a signal is sent (via instrumentation) to telemetry to indicate that the LEM is preparing for an abort; and a signal is sent to the LGC and AGS to compute and execute the abort trajectory, using the abort program.

The abort stage switch is actuated to initiate an abort, using only the ascent engine. Actuation of this switch causes the following events to occur: a command signal is sent to electroexplosive devices to pressurize the ascent engine; a signal is sent to the LGC and AGS to compute and execute the abort trajectory, using the abort stage program; a signal is sent (via instrumentation) to telemetry to indicate that the LEM is preparing to stage for an abort; the descent engine is shut down; and an "engine on" command is enabled, which fires the appropriate electroexplosive device to initiate vehicle staging. The LGC simultaneously turns on the ascent engine, and signals telemetry, via serial down-link, that the ascent engine has been started.

3-20. SYSTEM ENGINEER'S CENTER PANEL.

3-21. Flight Control. The controls and displays related to flight control are as follows: forward velocity/lateral velocity - LOS azimuth rate, LOS elevation rate indicator, flight director attitude indicator, rate/error monitor switch, and attitude monitor switch.

3-22. Caution Lights. The caution lights provide a yellow indication to alert the astronauts to a situation or malfunction that is not time-critical to their safety, but requires that they be aware of it. If a caution light goes on, the astronauts can alleviate the condition indicated. Lighting of a caution light is accompanied by a tone in the astronauts headset. Information concerning the malfunction is simultaneously telemetered to the ground monitoring station to ensure control station awareness of the situation in the LEM. The MASTER ALARM switch-light on the Systems Engineer's center panel and on the Commander's center panel provide a red indication when a warning or caution light goes on. Both master alarm switch-lights are extinguished and the tone silenced by pressing either MASTER ALARM

switch-light. Each caution light is extinguished only by a signal from the sensor at the malfunction, indicating restoration of a normal or within-tolerance condition.

3-23. Reaction Control. The controls and displays related to reaction control are as follows: fuel quantity indicator, oxidizer quantity indicator, temperature indicator, pressure indicator, system A switches and status flags, system B switches and status flags, thruster pair switches and status flags, temperature/pressure monitor select switch, quantity test switch, quantity monitor switch, and cross-feed switch and status flag.

The oxidizer and fuel quantity indicators display percentages of oxidizer and fuel remaining in system A or system B. The quantity monitor switch has SYS A, SYS B, and OFF positions. When the switch is set to SYS A, the oxidizer and fuel quantity indicators display the percentage of oxidizer and fuel quantity in system A. When the switch is set to SYS B, the oxidizer and fuel quantity indicators display the percentage of oxidizer and fuel quantity in system B. When the switch is set to OFF, d-c power is removed from the quantity indicators and no values are displayed.

The temperature indicator displays the temperature of the helium, fuel, and oxidizer tanks of system A and system B. The pressure indicator displays the pressure of the helium, fuel, and oxidizer tanks, and of the fuel or oxidizer manifolds of system A and system B. The temperature/pressure monitor select switch has He, FUEL, OXID, FUEL MANF, and OXID MANF positions. Selection of any of the five positions displays the corresponding temperature and pressure for systems A and B, on the temperature and pressure indicators.

The system A and system B switches and status flags consist of eight 2-position status flags that indicate the status (open or closed) of their respective latch-type solenoid valve, and four regulator switches, two main shutoff switches, and two ascent feed switches. The regulator switches control latch-type, solenoid-operated, shutoff valves (two each for systems A and B) upstream of the pressure regulators. Within each system (A and B), one valve is normally open; the other, normally closed. The main shutoff switches control the flow of fuel and oxidizer downstream of the propellant tanks, by means of solenoid valves. These valves are normally open; however, if a malfunction exists in system A or B, the malfunctioning system is shut down by setting the main shutoff switch for that system to CLOSE. The ascent feed switches control the fuel and oxidizer solenoid valves in the ascent tanks. If an RCS malfunction occurs, the ascent system can supply fuel and oxidizer to 8 or 16 thrust chamber assemblies while traveling in the +X-direction during ascent phases. This is accomplished by setting the ascent feed switch for system A or B, or both, to OPEN and the main shutoff switch for system A or B, or both, to CLOSE.

The thruster pair switches and status flags consist of eight 3-position status flags that indicate the status (open or closed) of their respective pair of latch-type solenoid valves, and eight thruster pair switches. The valves control the fuel and oxidizer flow to the thrust chamber assembly pairs. A red thruster pair flag is displayed if either or both thrust chamber assemblies fail. If such failure occurs, the appropriate thruster pair switch must be set to CLOSE, thus shutting down the malfunctioning pair and displaying a CLOSE condition.

The crossfeed switch controls two latch-type, solenoid-operated fuel and oxidizer crossfeed valves in a crossfeed piping arrangement between systems A and B. If the feed section of system A or B malfunctions, its appropriate main shutoff valve is closed and the crossfeed switch is set to OPEN, opening the crossfeed valves and permitting fuel and oxidizer to flow from the operative feed section to the thrust chamber assemblies of both systems.

The quantity test switch is used in conjunction with the quantity monitor switch and oxidizer and fuel quantity indicators to test the propellant quantity gaging section of system A or B. If the gaging system is operating correctly, the display will show prescribed test values at the oxidizer and fuel quantity indicators.

3-24. Environmental Control. The controls and displays related to environmental control are as follows: suit/cabin temperature indicator, suit/cabin pressure indicator, partial pressure CO₂ indicator, glycol temperature/pressure indicator, O₂ pressure, H₂O quantity indicator, CO₂ partial pressure light, H₂O separator light, O₂ pressure, H₂O quantity monitor select switch, suit fan select switch, and glycol pump select switch.

The suit temperature indicator displays the temperature (degrees Fahrenheit) in the suit circuit, as sensed at the suit circuit regenerative heat exchanger. The cabin temperature indicator displays the temperature (degrees Fahrenheit) of the cabin interior, as sensed at the cabin heat exchanger. The suit pressure indicator displays suit circuit pressure (psia), as sensed upstream of the suit gas supply connectors. The cabin pressure indicator displays cabin interior pressure (psia), as sensed by an

aneroid sensor on the cabin pressure sensor switch. The partial pressure CO₂ indicator displays the partial pressure (mm of Hg) of carbon dioxide in the atmosphere revitalization section.

The glycol temperature indicator normally displays the temperature of glycol (degrees Fahrenheit) in the primary coolant loop. However, following failure of the primary loop and selection of the emergency coolant pump, using the glycol pump select switch, this indicator displays the temperature of the glycol in the emergency coolant loop. The glycol pressure indicator normally displays the discharge pressure (psia) of the glycol pump in the primary coolant loop. However, following failure of the primary loop and selection of the emergency coolant pump, using the glycol pump select switch, this indicator displays the discharge pressure of the emergency glycol pump.

The O₂ pressure indicator displays the oxygen pressure (psia) remaining in the descent oxygen tank or in either of the two ascent tanks, as selected with the O₂ pressure/H₂O quantity monitor select switch. The H₂O quantity indicator displays the percentage of water remaining in the descent water tank or in either of the two ascent tanks, as selected with the O₂ pressure/H₂O quantity monitor select switch.

The O₂ pressure/H₂O quantity monitor select switch has C/W RESET, DES, ASC 1, ASC 2 positions. This switch selects, for monitoring on the O₂ pressure/H₂O quantity indicator, the pressure and quantities in the descent or ascent oxygen and water tanks. When the switch is set to DES, the pressure in the descent oxygen tank is displayed on the O₂ pressure indicator and quantity remaining in the descent water tank is displayed on the H₂O quantity indicator. When the switch is set to ASC 1, pressure in the No. 1 ascent oxygen tank is displayed on the O₂ pressure indicator, and quantity remaining in the No. 1 ascent water tank is displayed on the H₂O quantity indicator. When the switch is set to ASC 2, pressure in the No. 2 ascent oxygen tank is displayed on the O₂ pressure indicator, and quantity remaining in the No. 2 ascent water tank is displayed on the H₂O quantity indicator. When the switch is set to C/W RESET, either the O₂ pressure caution light or the water quantity caution light is extinguished if it was lit.

The suit fan select switch selects either of two suit fans to circulate breathing oxygen in the suit circuit. Normally, fan No. 1 is selected and operating. Failure of the selected fan results in lighting of an associated suit circuit fan component caution light. Selection of the No. 2 position activates the No. 2 fan and extinguishes the caution light.

The glycol pump select switch has 1, AUTO, 2 and EMER positions. This switch selects either of two circulating pumps in the primary coolant loop, or the circulating pump in the emergency coolant loop. Thus, normally, with the switch set to AUTO, the No. 1 pump operates. Failure of this pump results in automatic switchover to the No. 2 pump and lighting of the No. 1 pump component caution light. Selecting the 1 or 2 position activates that particular pump and bypasses the automatic switchover feature. Selection of the EMER position activates the glycol pump in the emergency coolant loop.

3-25. SYSTEM ENGINEER'S DISPLAYS AND CONTROLS.

3-26. SYSTEMS ENGINEER'S DATA ENTRY AND DISPLAY ASSEMBLY.

The data entry and display assembly (DEDA) is used to control manually the AGS modes of operation, manually insert data into the abort electronics assembly (AEA), and manually command the contents of a desired AEA memory core to be displayed on the DEDA.

3-27. SYSTEMS ENGINEER'S UPPER SIDE CONSOLE.

The Systems Engineer's upper side console consists of circuit breaker panels that have circuit breakers for the lighting; the window heaters; the Instrumentation Subsystem; Reaction Control Subsystem; Environmental Control Subsystem; Flight Displays; Guidance, Navigation and Control Subsystem; Explosive Detonates Subsystem; Communications Subsystem; Propulsion Subsystem; and Electrical Power Subsystem.

3-28. SYSTEMS ENGINEER'S CENTER SIDE CONSOLE.

The Systems Engineer's center side console consists of the electrical power control panel. The Systems Engineer controls the electrical power distribution from his electrical power control panel (center side console), which receives power from two ascent and four descent batteries. The batteries are installed in the LEM 16 hours before launch.

3-29. SYSTEMS ENGINEER'S LOWER SIDE CONSOLE.

The Systems Engineer's lower side console consists of an audio panel, communications panel, and a communications antennas panel.

3-30. Communications Panel. The communications panel has switches and controls that enable the Commander and Systems Engineer to operate S-band, VHF A, VHF B, telemetry control, tape recorder, and backup (secondary) S-band equipment. The VHF controls select simplex or duplex voice operation; a squelch control establishes the degree of noise limiting in the operating duplex receiver. The telemetry controls permit transmission of high- or low-bit-rate pulse-code-modulation or biomedical data from either astronaut. The tape recorder provides a 10-hour time-correlated recording capacity for voice. The tape recorder is used at the discretion of the astronaut.

3-31. Communications Antennas Panel. The communications antennas panel has indicators, switches, and a slew control for pointing the S-band steerable antenna at earth. The Systems Engineer initially selects a manual track mode and high or low slew rate and, by observing the azimuth and elevation antenna degrees indicators and received S-band signal strength indicator, adjusts the antenna attitude with the slew controls for maximum indication on the received S-band signal strength indicator.

When maximum indication is obtained, the Systems Engineer switches from manual track mode to the automatic track mode, which brings into operation an automatic earth-tracking circuit that causes the antenna to track the earth signals continuously. The panel contains two antenna selector switches: one for VHF; the other, for S-band. The VHF switch enables the operator to select either of two in-flight omnidirectional antennas, the extravehicular astronaut (EVA) antenna (for lunar stay), or a pre-egress checkout jack that enables the prospective EVA to check his PLSS communications with LEM and the Manned Space Flight Network (MSFN). The S-band switch selects either of two omnidirectional antennas, the steerable antenna (dish), or the erectable antenna (for lunar stay). The omnidirectional antennas are for backup use, as required.

3-32. THREE-AXIS ATTITUDE CONTROLLERS.

The three-axis attitude controller between the Commander's lighting panel and the bottom center panel permits the Commander to control attitude in all three axes. The three-axis attitude controller between the Systems Engineer's DEDA and lower side console provides the same capability for the Systems Engineer. Each attitude controller is spring restrained toward the center position. Side-to-side movement of the attitude controller provides roll attitude control, forward or aft movement provides pitch attitude control, and rotation of the attitude controller provides yaw attitude control. The attitude controllers operate in conjunction with the control electronics section (CES) of the GN & C Subsystem. Signals from the CES fire the required combination of the 16 thrust chamber assemblies in the RCS to stabilize the LEM during all phases of the mission.

3-33. THRUST/TRANSLATION CONTROLLERS.

One thrust/translation controller is at the Commander's station and one at the System Engineer's station. Both attitude controllers always provide the astronauts with translation capability along the Y-axis and Z-axis. X-axis translation capability is provided to the attitude controllers when the related throttle/jets select lever is set to JETS. When the throttle/jets select lever is set to THROTTLE and the manual throttle switch is set to CDR, thrust control of the descent engine is provided to the Commander's attitude controller. Thrust control of the descent engine is provided to the Systems Engineer when the throttle/jets select lever is set to THROTTLE and the manual throttle switch is set to SE.

Movement of the thrust/translation controller provides translational control as follows: out, in the -Z-axis; in, in the +Z-axis; up, in the +X-axis; down, in the -X-axis, left, in the -Y-axis; and right, in the +Y-axis.

The throttle/jets control select lever associated with each thrust/translation controller selects manual descent-engine throttling or RCS jets X-axis translation.

3-34. GUIDANCE, NAVIGATION, AND CONTROL SUBSYSTEM.

The Guidance, Navigation, and Control (GN & C) Subsystem provides the measuring and data-processing capabilities and control functions necessary to accomplish lunar landing and ascent, and rendezvous and docking with the Command/Service modules (CSM). The GN & C Subsystem comprises two functional loops, each of which is a completely independent guidance and control path. The primary guidance path performs all functions necessary to complete the LEM mission. If a major failure in the primary guidance path necessitates mission abort, the abort guidance path performs all functions necessary to effect a safe rendezvous with the orbiting CSM.

The primary guidance path (figure 3-3) comprises a primary guidance and navigation section (PGNS) and a control electronics switch (CES). The PGNS is an aided inertial guidance section whose principal aids are the landing radar (LR), the rendezvous radar/transponder (RR/T), and the alignment optical telescope (AOT). The CES processes the guidance and navigation data from the PGNS and applies them to the descent engine, the ascent engine, and selected RCS jets.

The inertial measurement unit (IMU), which continuously measures attitude and acceleration, is the primary inertial sensing device of the LEM. During descent to the lunar surface, the LR senses LEM attitude and velocity with respect to the lunar surface. During the coasting, descent, lunar stay, and rendezvous and docking phase of the mission, the rendezvous radar (RR) coherently tracks its transponder in the Command Module (CM) to derive range, range rate, and angle rate measurements with respect to inertial space. The LEM guidance computer (LGC) is the central data-processing device of the LEM. Using inputs from the LR, the IMU, the RR, the thrust translation control assembly (TTCA), the attitude controller assembly (ACA), and manually entered data derived from star sightings with the AOT, the LGC solves the necessary guidance, navigation, steering, and stabilization equations to initiate engine-on and engine-off commands for the descent and ascent engines, throttle commands and trim commands for the descent engine, and thruster-on and thruster-off commands for the selected Reaction Control Subsystem (RCS) jets.

The astronaut manually controls translation maneuvers and throttling of the descent engine with the TTCA, which is a T-handle hand control. The translation command signals generated by the TTCA are routed to the LGC; the throttle command signals are applied to the descent engine control assembly (DECA). The DECA sums throttle commands from the LGC and from the TTCA and applies the resultant signal to the descent engine. It also applies trim commands generated by the LGC to the gimbal drive actuators (GDA's) to provide trim control of the descent engine and routes descent engine-on and engine-off commands from the ascent engine latching device/sequences (AELD/S) to the descent engine. The LGC applies engine-on and engine-off commands for the ascent engine and the descent engine to the AELD/S. The AELD/S routes descent engine-on and engine-off commands to the DECA, applies ascent engine-on and engine-off commands directly to the ascent engine, and provides the power required to operate the engine solenoid valves.

The astronaut manually controls LEM attitude changes with the ACA, which is a three-axis, pistol-grip hand control. When the pistol grip is moved out of the detent position, proportional attitude rate commands are routed to the LGC. The LGC then calculates steering information and generates RCS jet commands that correspond to the mode of operation selected. These commands are applied to the jet drivers in the attitude and translation control assembly (ATCA), which generates thruster-on and thruster-off commands, and routes them to the proper RCS jets. If the astronaut commands a maximum attitude change by moving the pistol-grip to the hardover position, the ACA applies the hardover command directly to the emergency solenoids of the corresponding RCS jets.

Control of the LEM, when using the primary guidance path, ranges from fully automatic to fully manual. The primary guidance path operates in the automatic mode or the attitude-hold mode. In the automatic mode, all navigation, guidance, stabilization and control functions are controlled by the LGC, during the descent and the ascent phase of the mission. When the attitude-hold mode is selected, the astronaut uses the ACA to bring the LEM to a desired attitude. When he releases the ACA, the LGC generates commands to hold this attitude until a new attitude is selected. If the LEM is in the powered descent phase of the mission and the attitude-hold mode has been selected, throttling of the descent engine is normally accomplished automatically. The astronaut can, however, elect to control descent-engine throttling manually. Under this condition, the LEM is entirely under manual control. Table 3-3 summarizes the operation of the primary guidance path in both modes of operation.

The abort guidance path (figure 3-4) comprises an abort guidance section (AGS) and the CES. The AGS is a backup system for the PGNS. If it becomes necessary to abort the LEM mission, the AGS performs all inertial navigation and guidance functions necessary to effect a safe rendezvous with the CSM. The stabilization and control functions are performed by analog-computation techniques in the CES.

The AGS uses a strap-down inertial sensing technique, rather than the stabilized gimbal technique (the IMU) used in the PGNS. The abort sensor assembly (ASA) is a strap-down inertial sensor package that contains three gyroscopes, three accelerometers, associated electronics and a power supply. The ASA is installed in the LEM so that its coordinate axes correspond to the X-, Y-, and Z-axis of the LEM. The ASA applies gyro and acceleration data for each LEM axis to the abort electronics assembly (AEA). The AEA is a high-speed, general-purpose digital computer that performs the basic strap-down system computations and the abort guidance and navigation steering control calculations. The data entry and display assembly (DEDA) is a general-purpose input-output device through which the astronaut manually enters data into the AEA and commands various data readouts.

The CES performs the functions of an autopilot when the abort guidance path is selected. It uses inputs from the AGS and from the astronauts to provide the following: engine-on, engine-off, and throttling commands for the descent engine; gimbal commands to the GDA's to control descent engine trim; engine-on and engine-off commands for the ascent engine; engine sequencer logic to ensure proper arming and staging before engine startup and shutdown thruster-on and thruster-off commands to the RCS for translation and angular stabilization, and for various maneuvers; jet-select logic to select the proper RCS jets for the various maneuvers; and modes of LEM control ranging from fully automatic to manual, regardless of the phase of the mission in which the abort is initiated.

PRIMARY GUIDANCE AND NAV

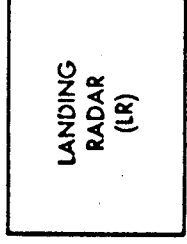

LEM VELOCITIES

ALTITUDE

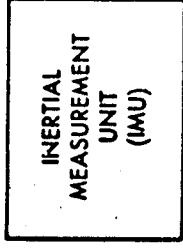

GIMBAL ANGLES

ACCELEROMETER DATA

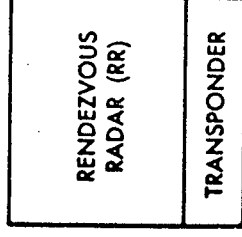

RANGE

RANGE RATE

TRACKING ANGLES

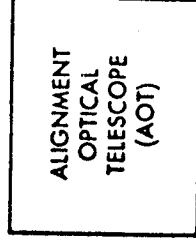

ALIGNMENT
OPTICAL
TELESCOPE
(AOT)

DATA DERIVED FROM
STAR SIGHTINGS

VIGATION SECTION

CONTROL ELECTRONIC

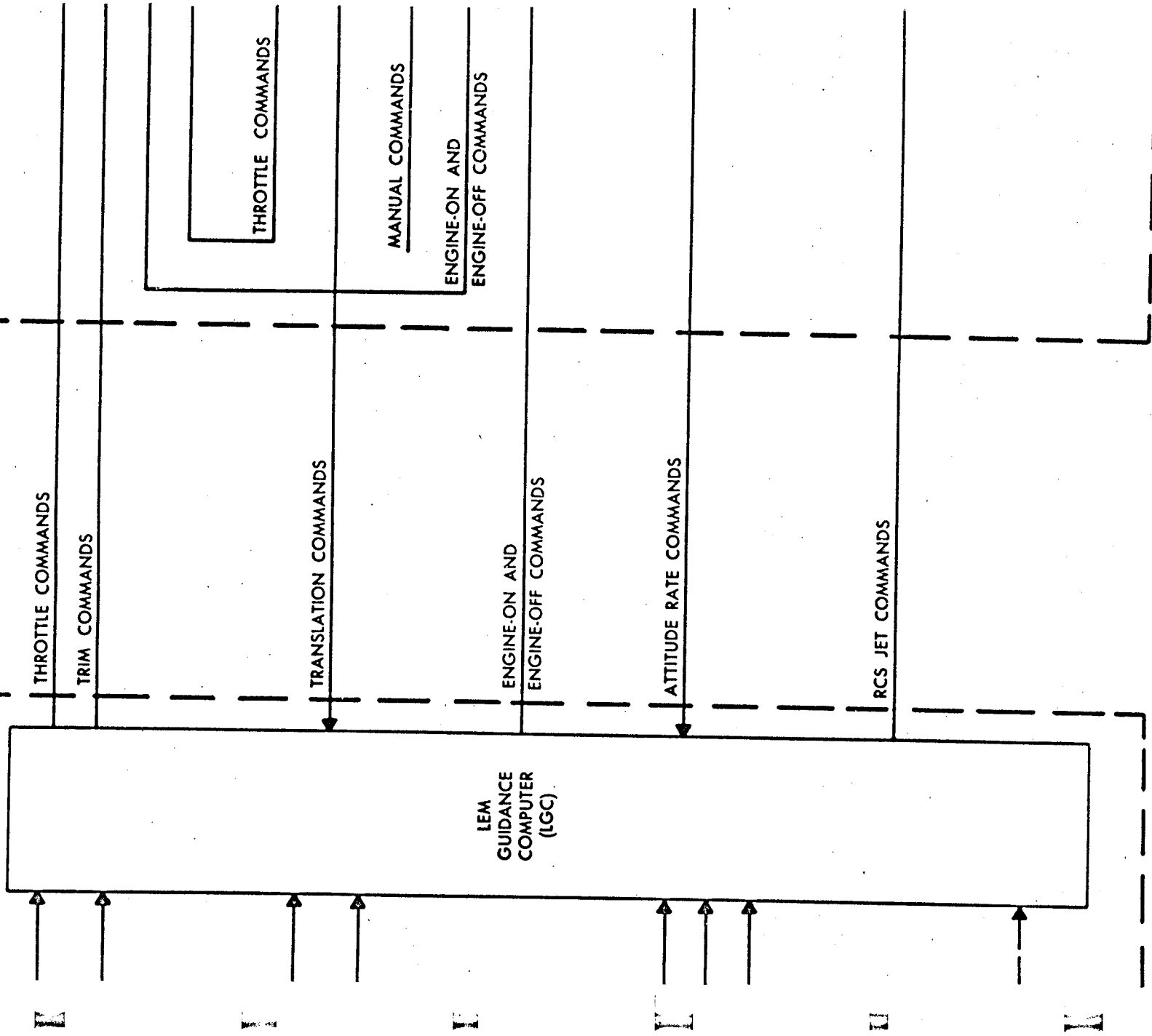

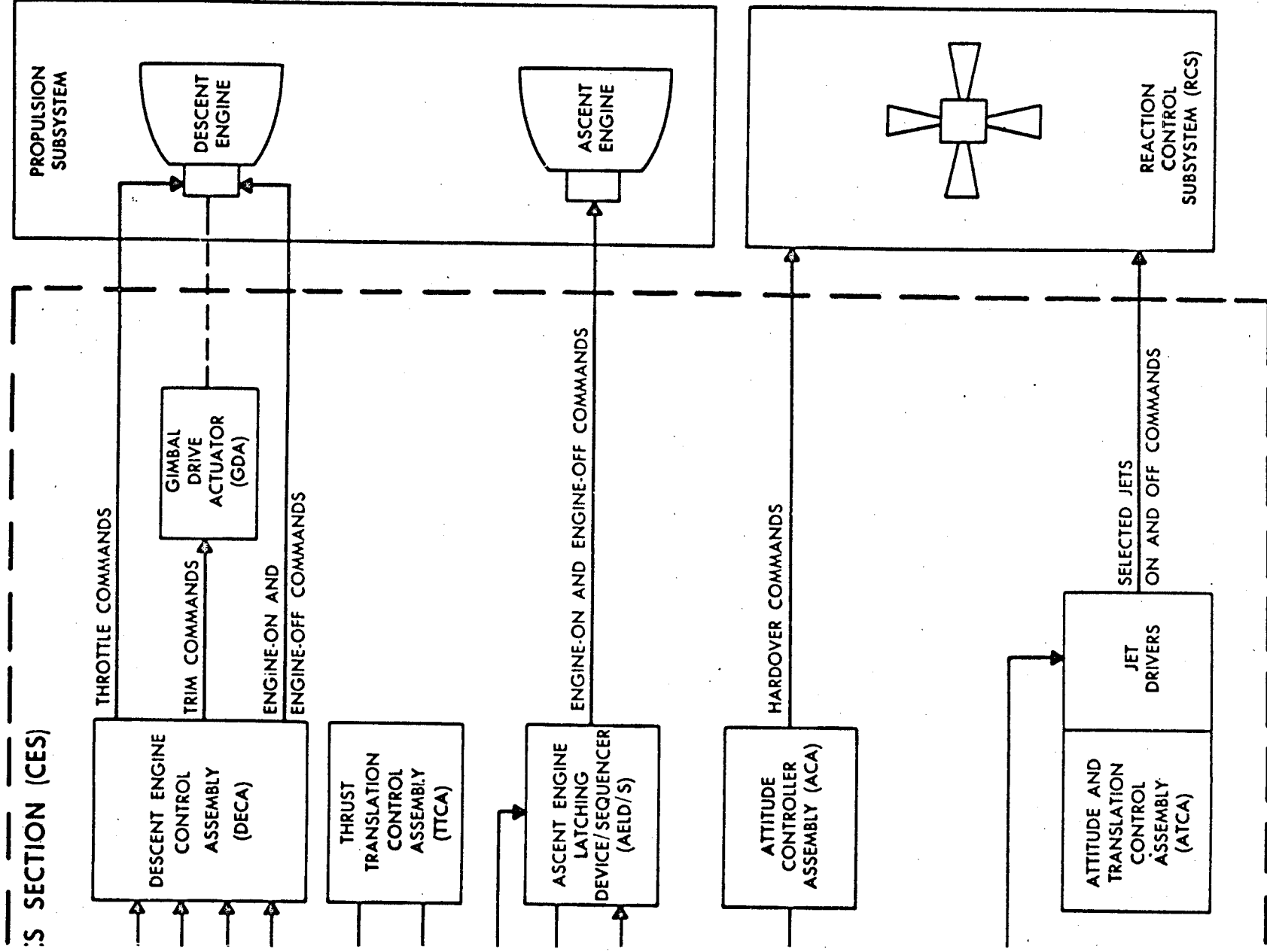

201LMA10-58

Figure 3-3. Primary Guidance Path Simplified Block Diagram

ABORT GUIDANCE SECTION

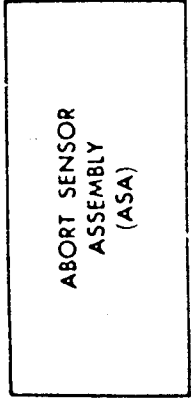

GYRO DATA

ACCELEROMETER DATA

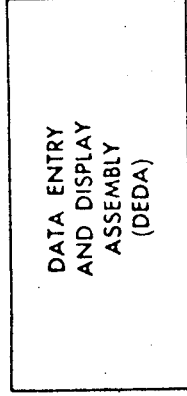

DATA ENTRY

DATA READOUT

CONTROL ELECTRONICS SECTION

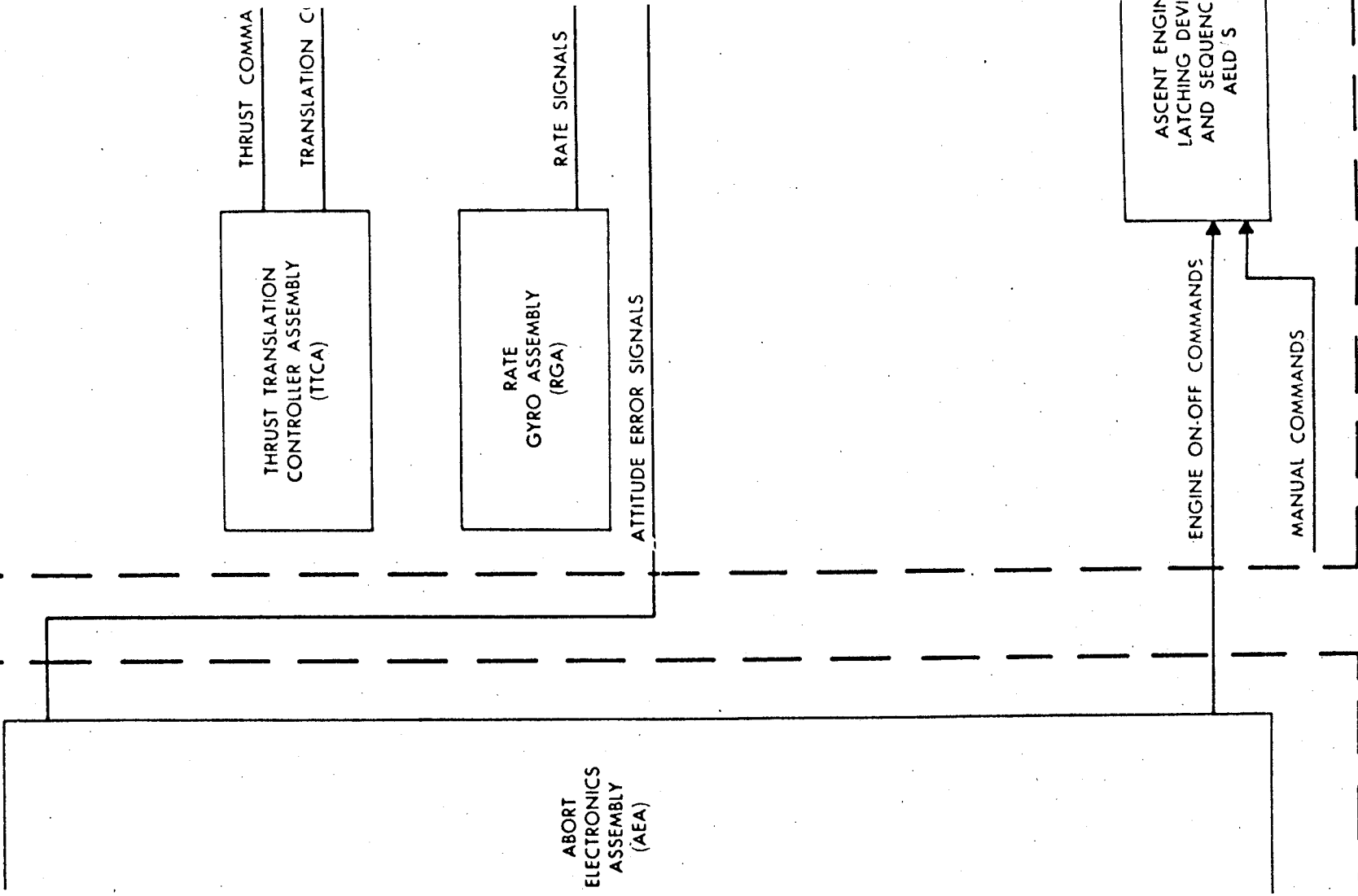

II

II

ABORT
ELECTRONICS
ASSEMBLY
(AEA)

II

II

II

II

II

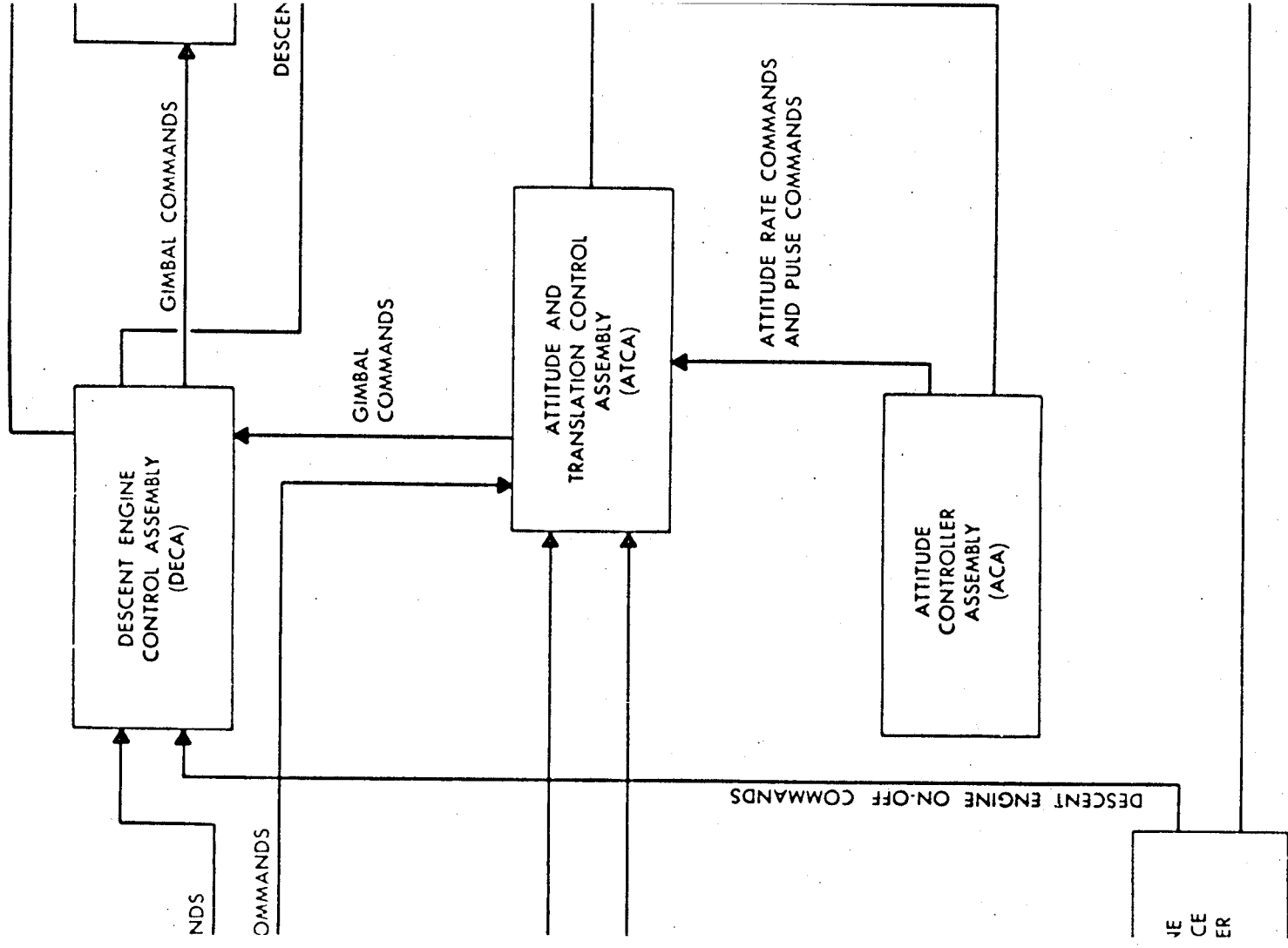

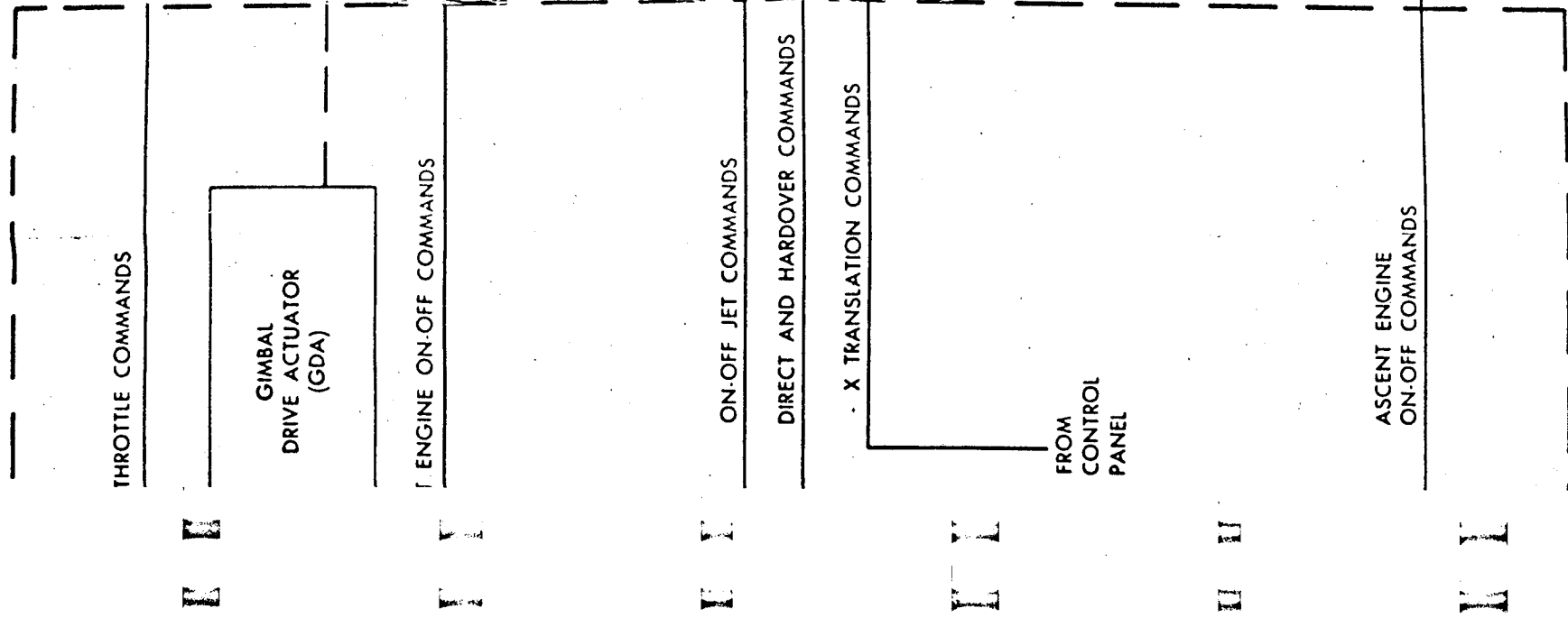
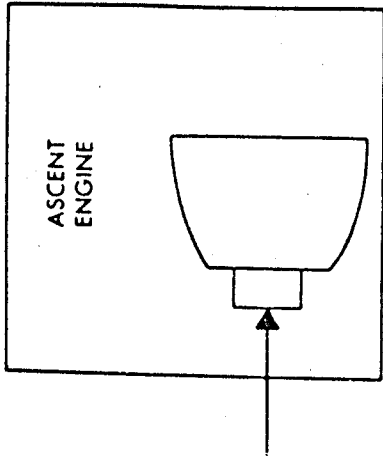
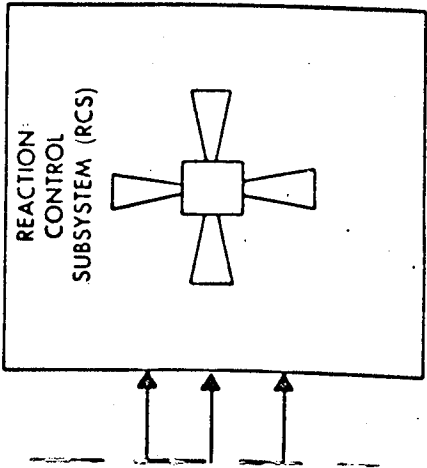
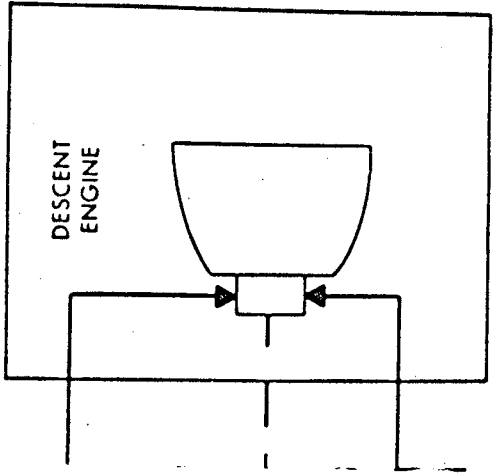

Figure 3-4. Abort Guidance Path Block Diagram



2011MA10.57

gram

3-15/3-16

Table 3-1. Primary Guidance Path Modes and Functions

Function	Automatic Mode	Attitude-Hold Mode
Engine control	Ascent and descent engine are turned on and off automatically. Pitch and roll trim commands are applied directly to gimbal power control circuitry in GDA's. Descent engine throttling is controlled automatically.	Same as automatic mode, except that descent engine throttling can be controlled automatically or manually.
Automatic guidance	LGC generates automatic steering and translation commands and applies them directly to ATCA jet drivers.	LGC generates vehicle-stabilization commands, and applies them directly to ATCA jet drivers.
Manual attitude control	Refer to "override capabilities".	Astronaut commands attitude changes by proportional displacement of ACA pistol grip. LEM attitude is maintained when ACA pistol grip is in detent position.
Manual translation control	Astronaut commands linear translation by proportional displacement of handle of TTCA.	Same as automatic mode.
Attitude rate damping	Rate compensation accomplished within LGC.	Same as automatic mode.
Override capabilities	Override of attitude-control function is effected by moving ACA pistol grip to hardover position for ON-OFF RCS-jet operation. ACA routes commands directly to secondary coils of thruster solenoid valves. Override of automatic +X-axis translation function is effected with X-TRANSL switch which routes commands directly to secondary coils of thruster solenoid valves. Astronaut then commands X-axis rates by proportional displacement of ACA pistol grip.	Same as automatic mode.

The astronaut uses the TTCA to control throttling of the descent engine and translation maneuvers. The throttle commands, as engine-on and engine-off commands from the AELD/S, and trim commands from the ATCA are applied to the DECA. The DECA applies the throttle commands to the descent engine, the engine-on and engine-off commands to the descent engine latching devices, and the trim commands to the GDA's. The AELD/S receives engine-on and engine-off commands for the descent and ascent engines from the AEA. As in the primary guidance path, the AELD/S routes descent engine-on and engine-off commands to the DECA and applies ascent engine-on and engine-off commands directly to the ascent engine.

The astronaut uses the ACA to control the LEM attitude. The ACA routes attitude rate commands and pulse commands to the ATCA and direct commands and hardover commands to the RCS. The pulse commands and direct commands are used when the abort guidance path is in the attitude-hold mode. The astronaut can select either type of command for each axis. If the pulse commands are selected for a given axis, the ATCA causes the RCS jets that control that axis to be fired at 2 cps at approximately minimum impulse. If the direct commands are selected, the corresponding RCS jets are fired on when the ACA pistol grip is moved out of the detent position; they are turned off when the pistol grip is returned to the detent position. The hardover commands perform the same function as in the primary guidance path.

The attitude rate commands generated by the ACA, error signals from the AEA, rate-damping signals from the rate gyro assembly (RGA), and translation commands from the TTCA are applied to the ATCA. The ATCA processes these commands to generate thruster-on and thruster-off commands, and routes them to the proper RCS jets. In addition, the ATCA routes trim commands to the DECA for trim control of the descent engine.

The abort guidance path operates in the automatic mode or the attitude-hold mode. In the automatic mode, navigation and guidance functions are controlled by the AGS; stabilization and control functions, by the CES. In the attitude-hold mode, pulse and direct submodes are available for each axis. These submodes are selected with the ATTITUDE CONTROL ROLL, PITCH, and YAW switches on the control panel. The pulse submode is an open-loop attitude-control mode in which the ACA is used to make minimum-impulse attitude changes in the selected axis. The direct submode is an open-loop attitude control mode in which pairs of RCS jets are directly controlled by the ACA. The astronaut can manually override automatic or semiautomatic attitude control in any axis by moving the ACA pistol grip to the hardover position, causing direct firing of the corresponding RCS jets through their secondary (emergency) solenoids. In addition, the astronaut can override translation control in the +X-axis with the X-TRANSL pushbutton on the control panel. This pushbutton causes all four of the +X-axis RCS jets to fire. Table 3-2 summarizes the modes of operation of the abort guidance path.

Table 3-2. Abort Guidance Path Modes and Functions

Function	Automatic Mode	Attitude-Hold Mode
Engine control	Ascent and descent engines are turned on and off automatically. Descent engine can be throttled automatically or manually.	Same as automatic mode.
Automatic guidance	Automatic steering commands are generated by AGS and applied to CES to control changes in attitude.	<p><u>Normal:</u> Automatic stabilization commands are generated by AGS and applied to CES to maintain attitude commanded by astronaut.</p> <p><u>Pulse:</u> Guidance commands for selected axis are interrupted.</p> <p><u>Direct:</u> Guidance commands for selected axis are interrupted.</p> <p><u>Normal:</u> Astronauts command attitude angular velocity rates by proportional displacement of ACA pistol grip. LEM attitude is maintained when ACA pistol grip is in detent position.</p> <p><u>Pulse:</u> Astronauts command angular acceleration in selected axis through low-frequency pulsing of RCS jets.</p> <p><u>Direct:</u> Astronauts command angular acceleration in selected axis through on-off firing of RCS jets.</p>
Manual attitude control	Refer to "override capabilities."	
Manual translation control	Astronauts command translation along any axis by proportional displacement of T-handle of TTCA.	Same as automatic mode.
Attitude rate damping	Rate gyro signals are summed with steering signals.	<p><u>Normal:</u> Rate gyro signals summed with stabilization signals.</p>

Table 3-2. Abort Guidance Path Modes and Functions (Cont)

Function	Automatic Mode	Attitude-Hold Mode
Attitude rate damping (cont)		Pulse and Direct: There is no rate damping in selected axis.
Override capabilities	Override of attitude-control function is effected by moving ACA pistol grip to hard-over position for on-off RCS-jet operation. ACA routes commands directly to secondary coils of thruster solenoid valves. Override of automatic +X-axis translation function is effected with X-TRANSL switch, which routes commands directly to secondary coils of thruster solenoid valves. Astronaut then commands X-axis rates by proportional displacement of ACA pistol grip.	Same as automatic mode

3-35. PRIMARY GUIDANCE AND NAVIGATION SECTION. (See figure 3-5.)

The primary guidance and navigation section (PGNS) is primarily an aided inertial guidance and navigation system that provides all guidance, navigation, autopilot stabilization, and control computations necessary to complete the LEM mission. The PGNS comprises the landing radar (LR), the rendezvous radar/transponder (RR/T), the alignment optical telescope (AOT), the inertial measurement unit (IMU), five coupling data units (CDU's), the LEM guidance computer (LGC), and the power and servo assembly (PSA).

3-36. Landing Radar. (See figure 3-6.) The landing radar (LR) senses LEM velocity and altitude with respect to the lunar surface when the LEM is moving in a tangential approach (Phases I and II of the landing maneuver) to the lunar surface and when it rotates to a vertical attitude to complete its final descent. Velocity and altitude information is applied to the LGC, where it is used to check or update inertially-derived data, and is also displayed during descent from an altitude of 40,000 feet to touchdown. The LR is composed of an antenna assembly, electronics assembly, and a control assembly; it is functionally divided into a three-beam, continuous-wave (cw) doppler velocity sensor and a narrow-beam, linear fm/cw radar altimeter. The antenna assembly comprises a space-duplexed array of transmit and receive antennas on which solid-state transmitters, a modulator, detectors, pre-amplifiers, test modulators, and waveguides are mounted. The transmit array generates four beams. Three of these are arranged in a lambda configuration and are used by the doppler velocity sensor; the fourth beam is used by the radar altimeter (see figure 3-7). The receiving antennas comprise four broadside arrays. Because the receiving array beamwidths are wider than those of the transmit array, antenna boresighting is not critical. The electronics assembly contains frequency trackers, coordinate converters, a high-speed counter, and a power supply. It provides the LGC with binary word inputs that correspond to the range along the altitude beam. Outputs to controls and displays permit display of LEM velocity components (in antenna coordinates), and range along the altitude beam. The LR supplies accurate data from 25,000 feet to touchdown without mode changes or altitude holes and has provision for hovering and negative speeds. Self-test devices within the LR enable operational checks of the entire LR without radar returns from the lunar surface; the astronauts can evaluate the operational status of the LR at any time during the LEM mission.

3-37. Doppler Velocity Sensor. The doppler velocity sensor comprises a solid-state transmitter, frequency trackers, and beam-to-orthogonal velocity converters; it provides the desired doppler frequencies and LEM component velocity outputs. The received energy from each beam is detected with the direct-to-audio detection technique. The received signals are detected in quadrature to retain sign sense and applied to dual preamplifiers. Unwanted transmitter leakage is heterodyned to zero and rejected because the detectors are a-c coupled to the preamplifiers. The amplified quadrature doppler signals for each beam are then applied to velocity sensor frequency trackers, which search the band of expected doppler frequencies with a narrow-bandwidth filter. When the doppler signal appears in the tracker band, the tracker locks on and continuously tracks and filters the doppler spectrum. The outputs (f_c+D_1 , f_c+D_2 , f_c+D_3) of the velocity sensor frequency trackers are converted to V_{xa} , V_{ya} , and V_{za} and applied in prf form to the high-speed counter and, then, to the LGC. The converter also generates output signals representing three orthogonal velocities and range rate along the altitude beam, which are supplied to displays.

3-38. Radar Altimeter. The radar altimeter is of the narrow-beam, linear, fm/cw type; it comprises a solid-state transmitter, frequency tracker, and altitude converter and provides outputs that represent range along the altitude beam. The received energy is detected in a manner almost identical with that of the doppler velocity sensor. The detected quadrature signals are amplified in a dual preamplifier and applied to the altimeter frequency tracker. The frequency along the range beam is the sum of the range frequency and the doppler frequency ($f_r + f_d$). The doppler component is removed in the altitude converter by mixing operations; the range frequency signal is applied to the altitude frequency converter, where the range signals are derived.

3-39. Rendezvous Radar Transponder. (See figure 3-8.) The primary function of the rendezvous radar/transponder (RR, T) is to provide range, range rate, tracking angles, and tracking angle rates to the LGC to enable computation of a trajectory from the moon to a point in space where the final docking of the LEM to the CSM can begin. The RR can be used during the lunar descent trajectory to track a landing beacon; in an emergency as an aid in determining the validity of signals from either the LR or DMU when the data from the two equipments do not agree. Outputs from the RR are displayed on the Commander's center panel.

When the LEM is on the lunar surface, the RR tracks the associated transponder in the CSM. During the LEM ascent coasting phases, the RR is used for monitoring or midcourse correction maneuvers. As a backup system for the LR during lunar landing, the RR can track a transponder at or near the landing site on the lunar surface. It can also be used for skin- or surface-tracking for limited ranges.

The RR has two basic modes of operation: the transponder mode and the skin/surface mode. Each mode can be controlled automatically or manually. In the transponder mode, the RR operates in conjunction with a transponder in the CSM or on the lunar surface. In the skin/surface mode, the RR operates without a transponder and tracks the surface of the CSM or the lunar surface. When automatic operation of the RR in the transponder or skin/surface mode is selected, the RR is controlled by inputs from the LGC. During manual operation, the astronauts control the RR with controls and indicators on the radar panel of the Commander's lower side console.

The RR antenna assembly includes a gyro-stabilized monopulse antenna; sum-and-difference hybrid networks; a duplexer; a high-level, solid-state varactor-multiplier-transmitter; three mixers; and three i-f preamplifiers. The shaft-error receiver, sum-channel receiver, and trunnion-error receiver are identical i-f assemblies that convert the reference and error signals to an intermediate frequency. The sum-channel receiver output is used as a reference signal for the two phase-sensitive detectors within the angle track module. These detectors convert the output of the shaft- and trunnion-error receivers into two bi-polar-video angle-error signals.

The frequency synthesizer generates the basic stable frequencies required for operation of the frequency tracker, range tracker, modulator, and RR logic circuits. The 6.8-mc signal is used in the range tracker as a reference signal; the 3.4-mc signal is used for generation of 200-cps, 6.4-kc, and 204.8-kc tones.

The range tracker provides range information to the LGC in digital form via the RR logic circuits and to the displays. It operates with transponder or with CSM-skin or lunar-surface return. There are two range tracker modes. During transponder operation, a multitone ranging system is used; during the skin/surface mode, a variable prf is used to determine range.

When the transponder mode is selected, RR transmission is phase-modulated with sine-wave, 200-cps, 6.4-kc, and 204.8-kc tones. By comparing the phase of the received 200-cps tone with the phase of the transmitted 200-cps tone, unambiguous range measurements can be made from 0 to 390 miles. Similar phase comparisons made with the 6.4-kc and 204.8-kc tones provide successive refinement of ranging accuracy. The lower-frequency tone is used for coarse range data extraction; the higher-frequency tone provides fine range data. When the skin/surface mode is selected, the RR transmitter prf is varied inversely with range from 40,000 to 500 feet. The range rate data is extracted by the RR doppler frequency tracker, which nulls through the band of expected received doppler frequencies. The output of the doppler frequency tracker represents the range rate data.

The angle track module converts shaft- and trunnion-error signals to d-c error signals, which are used to position the RR antenna. In addition, the angle trackers generate the agc signal that is displayed on the radar panel and regulate the gain of the i-f amplifiers.

The RR logic circuits provide the interfaces between the RR and the LGC. Radar output signals are processed into the format required by the LGC and selected sequentially for transfer by coded strobe signals generated by the LGC.

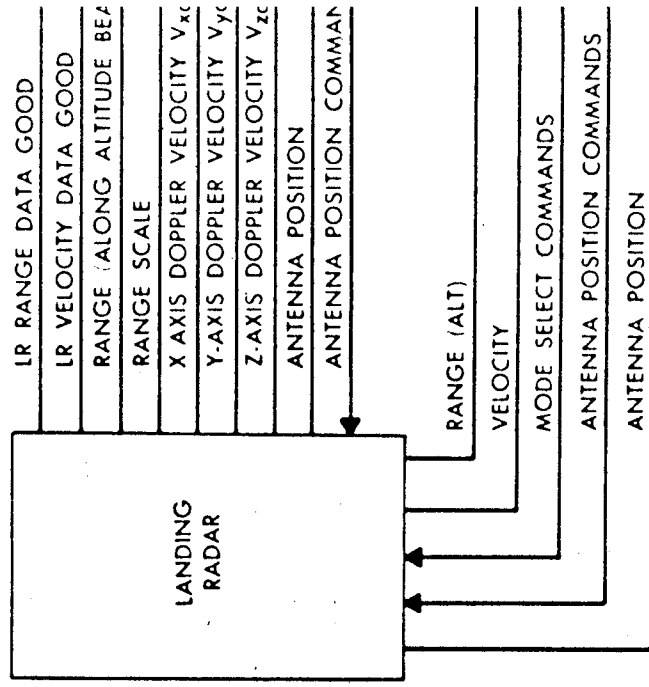
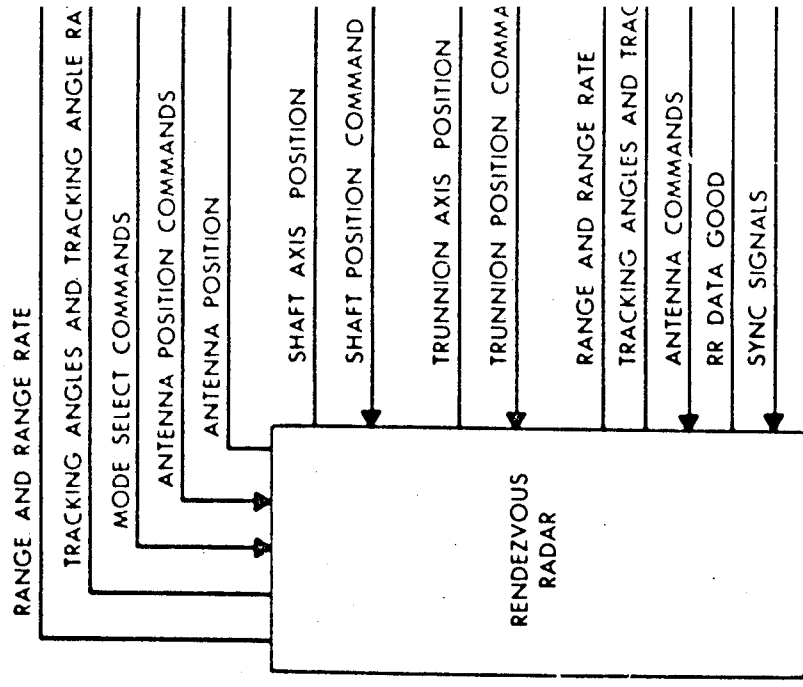

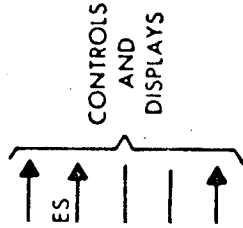

ALIGNMENT OPTICAL TELESCOPE

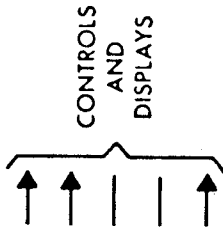
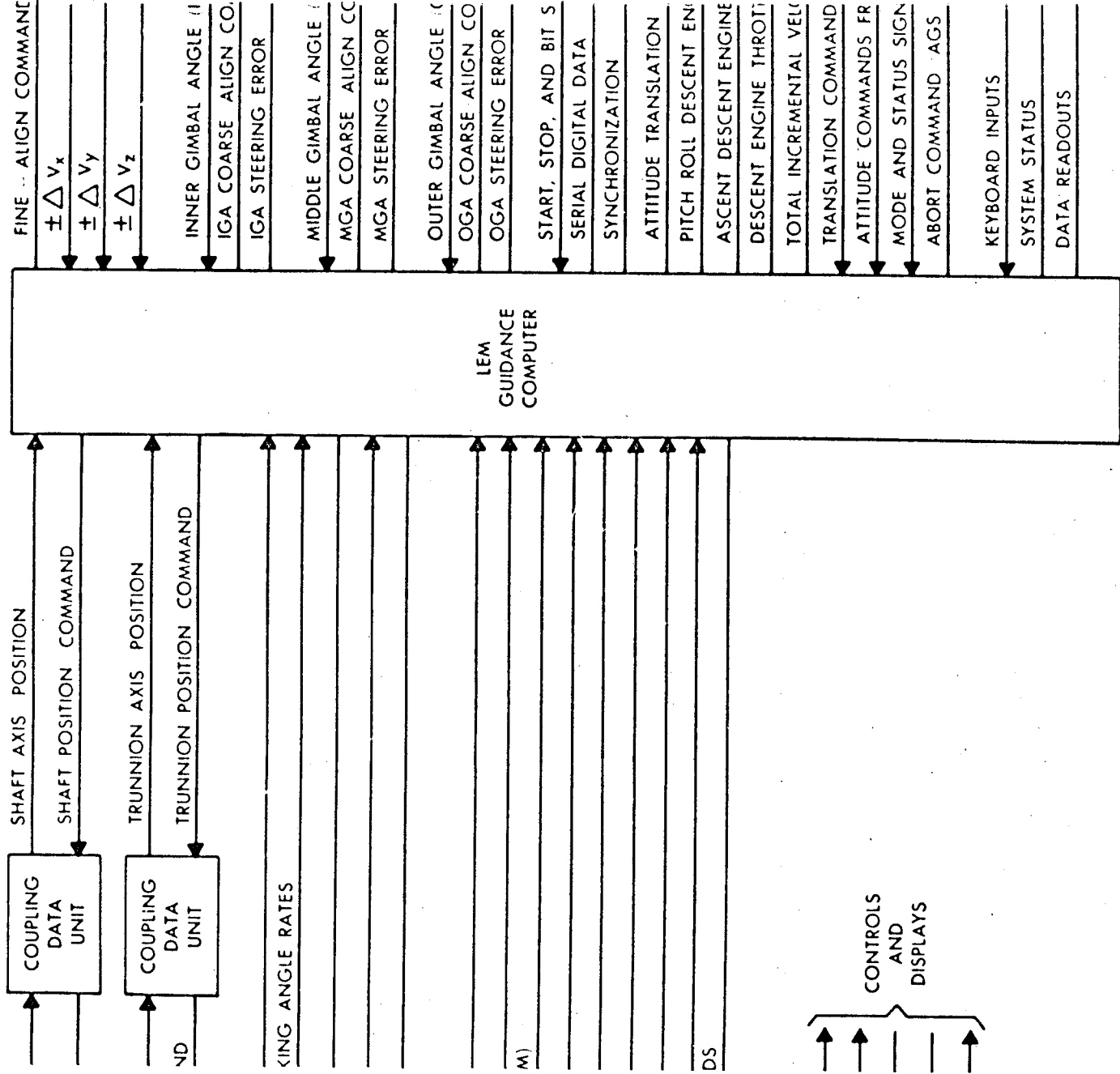

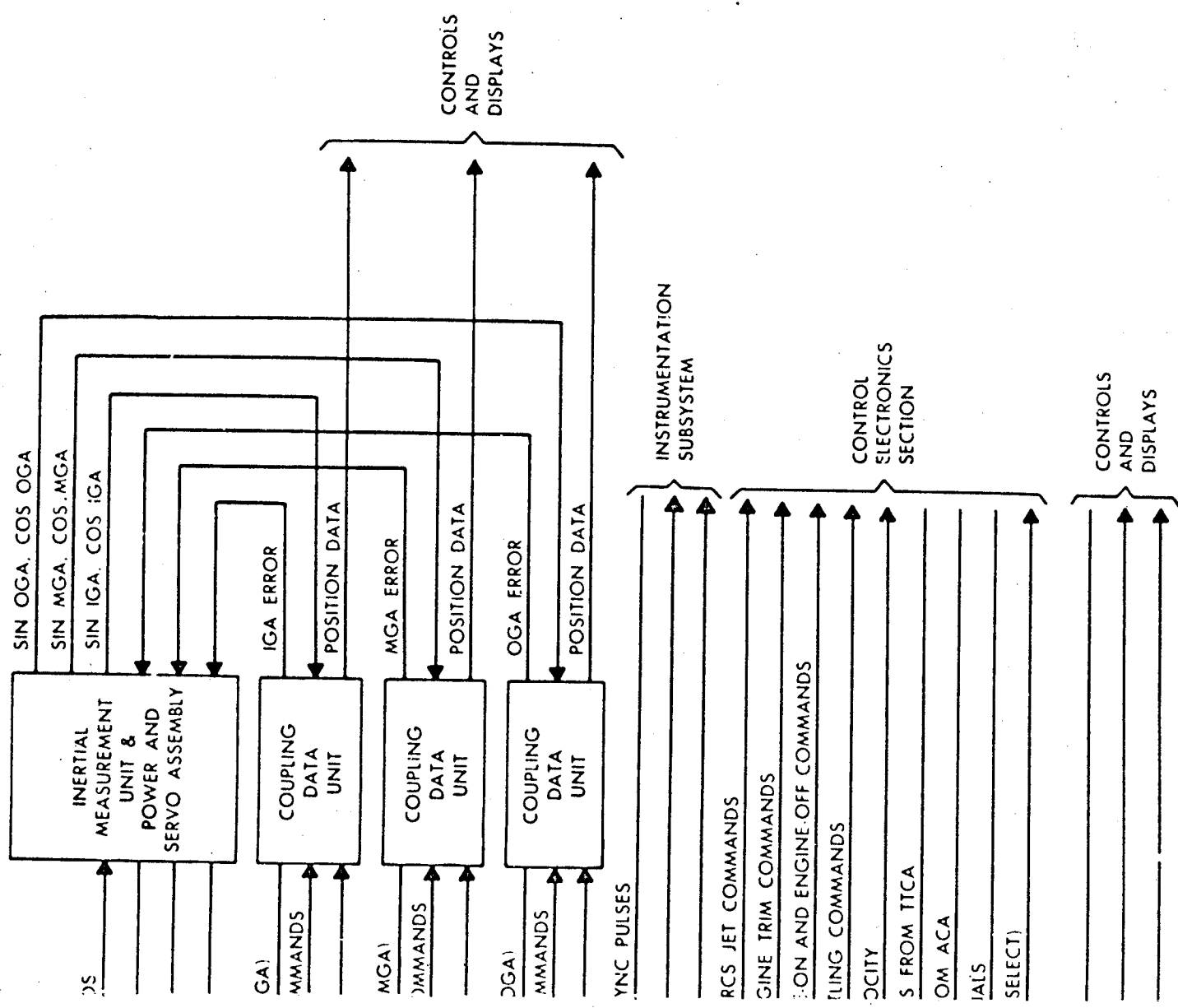

B-201LMA10-24

Figure 3-5. Primary Guidance and Navigation Section Block Diagram

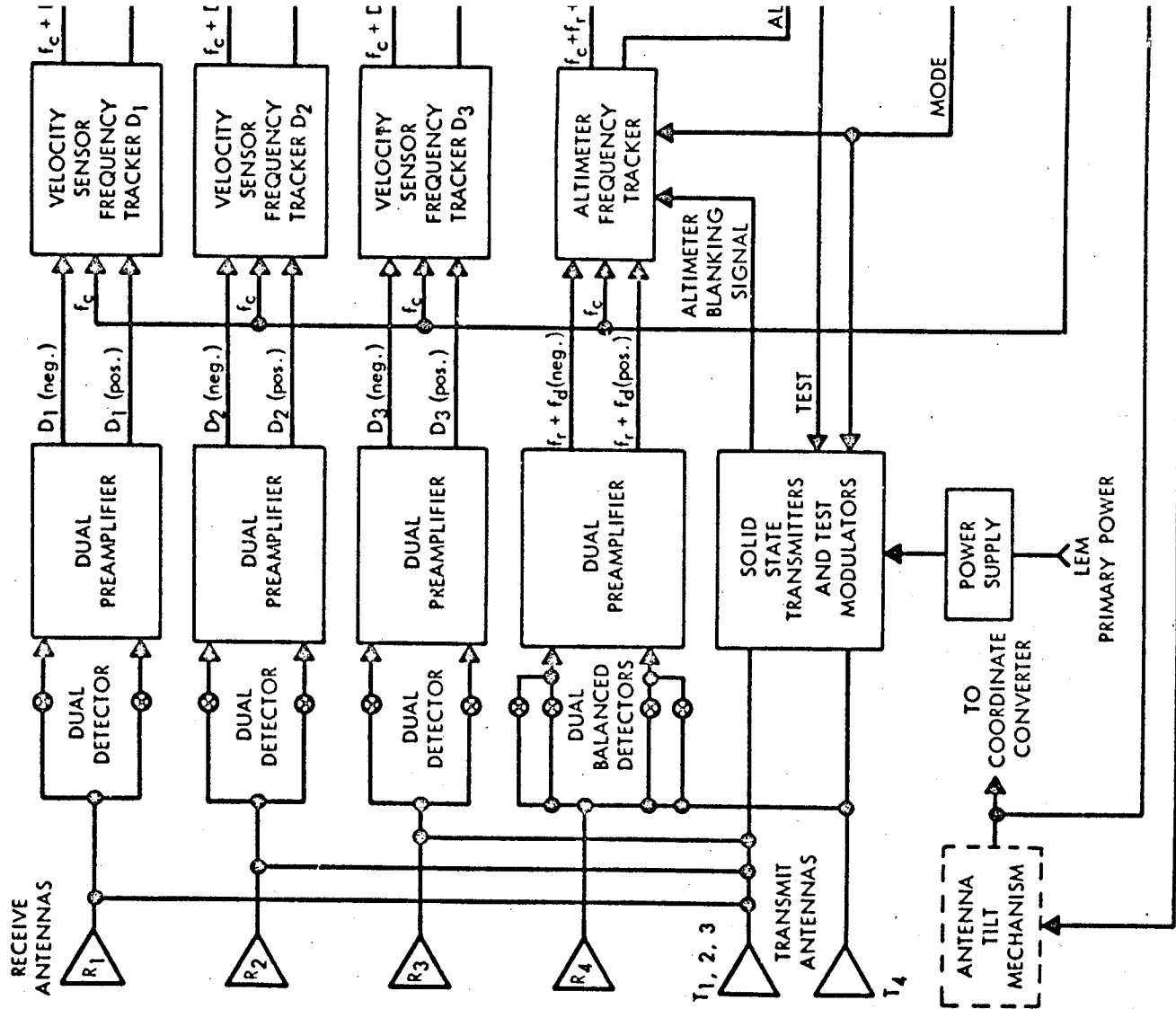

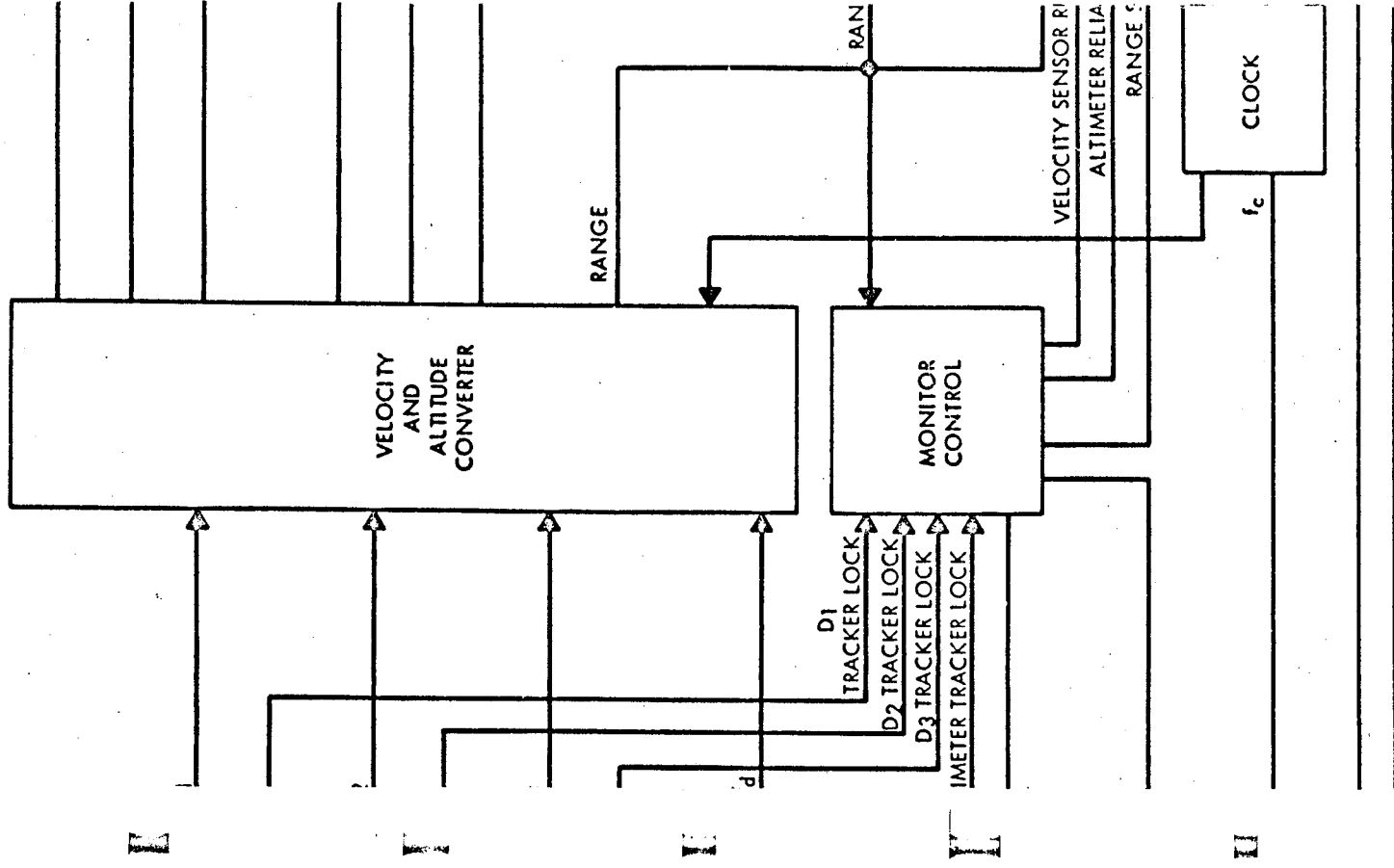
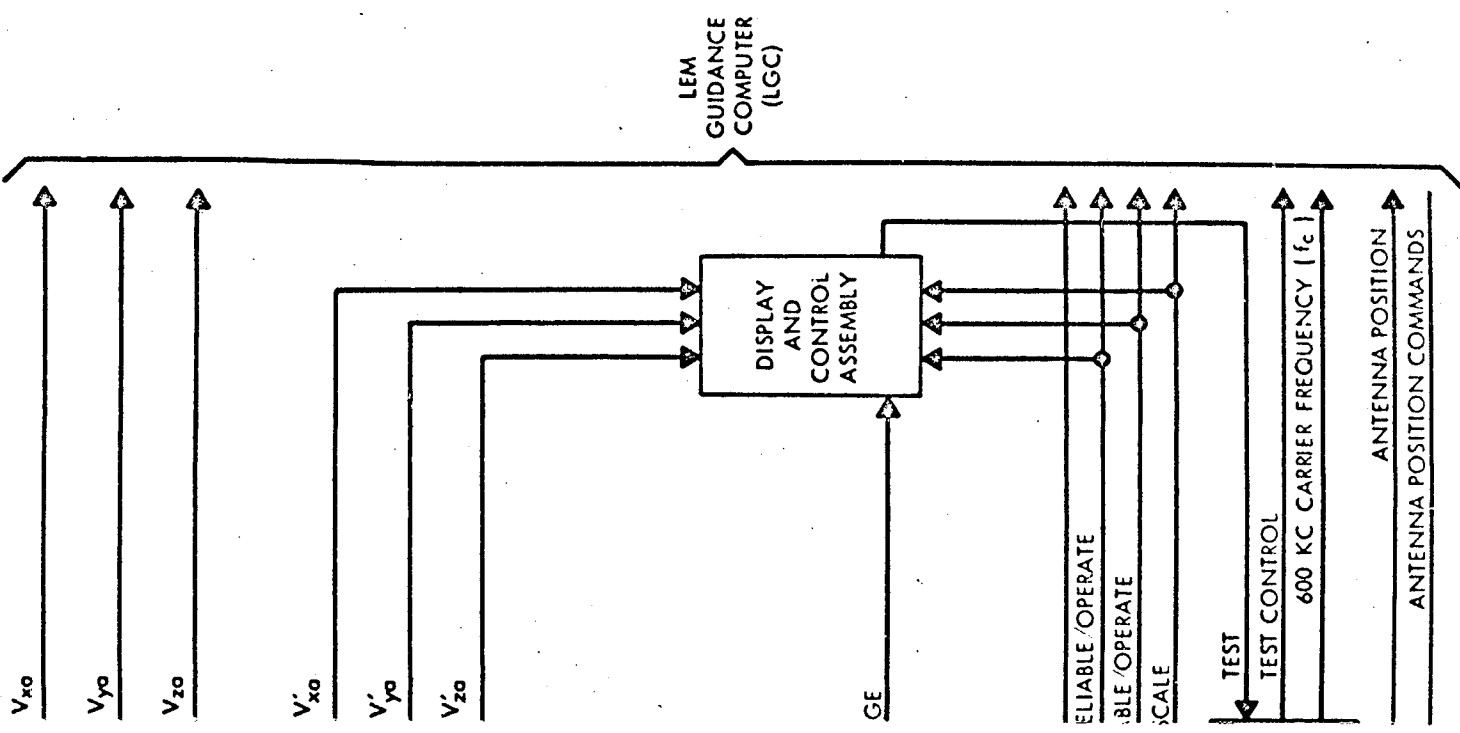

Figure 3-6. 1



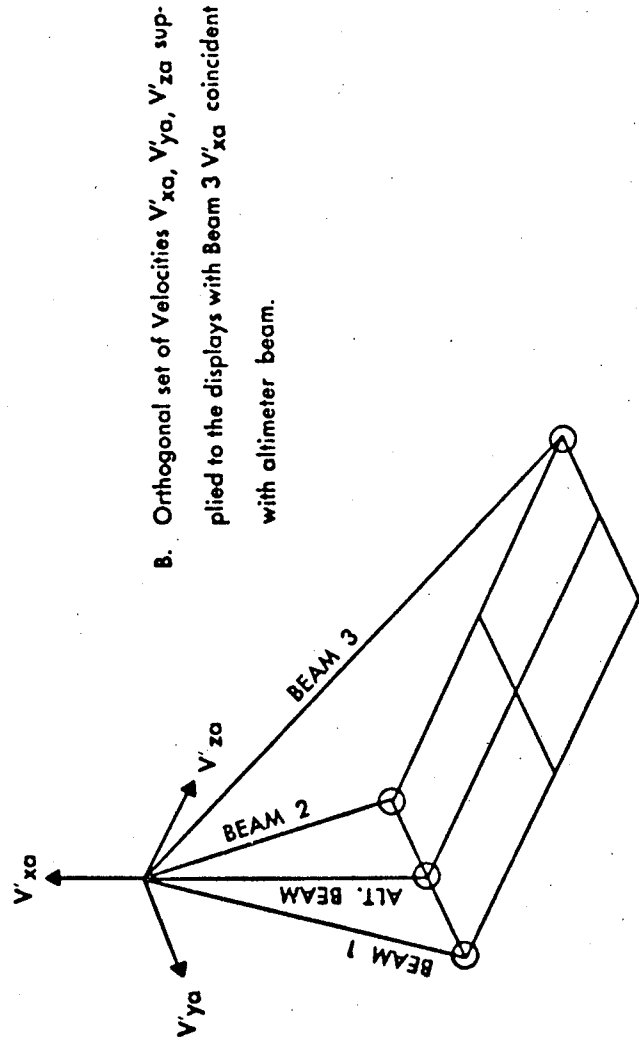
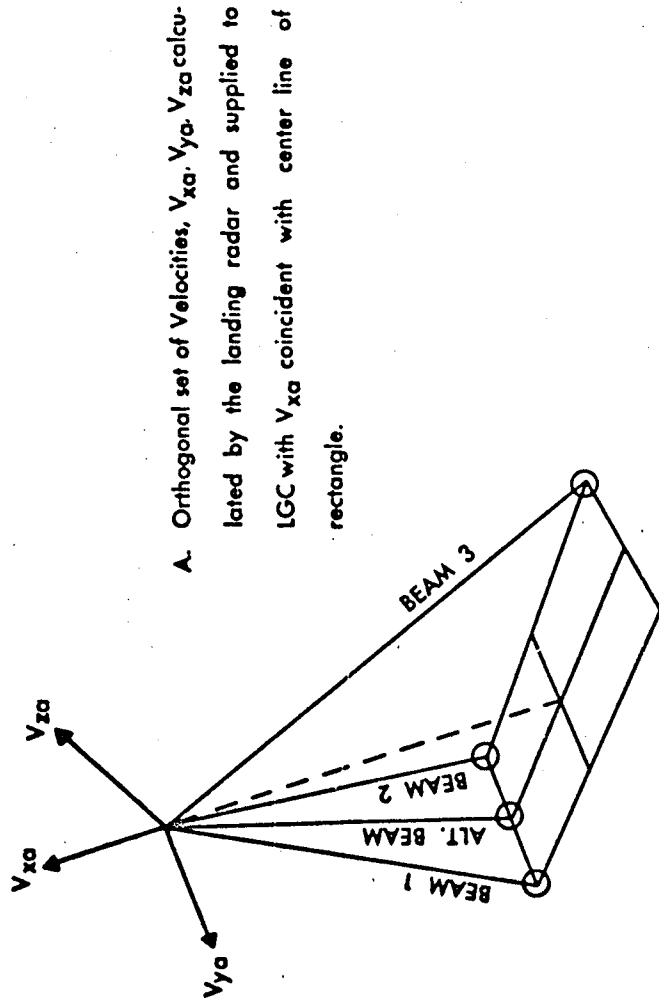

Figure 3-7. Landing Radar Velocity Components

3-40. Alignment Optical Telescope.

The alignment optical telescope (AOT) is a nonarticulating, unit power, 60° field-of-view periscope. The astronauts derive inertial-reference data by sighting two or more celestial bodies with the AOT and measuring the angles between the lines of sight. The AOT is installed parallel to the LEM X-axis. The optics mechanism has a stowage position and three detents. The detents are at 0° (along the Z-axis), 60° to the left, and 60° to the right.

The reticle pattern of the AOT consists of a set of crosshairs and a one-turn spiral. The crosshairs are used for measurements while in lunar orbit; the spiral is used for lunar-surface measurements. The astronauts measure the angles between lines-of-sight by rotating the reticle and observing a readout device. In orbit, the crosshairs are rotated to the zero position and the LEM is rotated to allow a navigational star to cross the X- and Y-crosshairs. As the star crosses each line, information representing the angle from zero is manually entered into the LGC in the form of a mark-X or mark-Y signal. The LGC uses this data to check or update the inertial alignment of the IMU. Lunar-surface measurements are made by rotating the reticle so that the spiral cross the target and then manually entering the angle from zero into the LGC.

3-41. Inertial Measurement Unit. The inertial measurement unit (IMU) is the primary inertial sensing device of the LEM. Three rate-integrating gyroscopes and three pendulous accelerometers are mounted on the innermost gimbal of a three-degree-of-freedom gimbal system. The innermost gimbal is held nonrotating with respect to inertial space by three gimbal servos, which derive their input error signals from the three gyroscopes. The input axes of the three accelerometers represent the X -, Y -, and Z-axis of the LEM. All changes in velocity, except those by the effects of the gravitational fields of the earth or the moon, are sensed by the accelerometers. The output of each accelerometer represents incremental changes in velocity and is applied to the LGC for the calculation of total velocity. The IMU resolvers, which are mounted on each of the three gimbals, continuously measure LEM attitude with respect to the inner gimbal. The analog outputs of these resolvers are converted to a digital format and applied to the LGC by three coupling data units. The LGC uses the resolver data and data derived from star sightings taken with the AOT to compute error signals that maintain the inner gimbal of the IMU at the desired reference position.

The IMU, the AOT, and the abort sensor assembly (ASA) are mounted on a navigation base. The IMU is mounted so that its outer gimbal axis is parallel to the LEM X-axis.

3-42. Coupling Data Units. Each coupling data unit (CDU) consists of a digital-to-analog converter and an analog-to-digital converter. Five CDU's are in the GN & C Subsystem: one for the shaft axis, one for the trunnion axis of the RR antenna, and one for each of the three gimbals of the IMU.

The LGC calculates digital antenna-position commands, which are converted into analog antenna-drive signals by two CDU's and applied to the antenna drive mechanism to aim the antenna at the orbiting CSM. Following transponder acquisition, CSM tracking information is digitized by these CDU's and applied to the LGC.

The three CDU's used with the IMU provide interfaces between the IMU and the LGC, and between the IMU and the Controls and Displays Subsystem. Each IMU gimbal angle resolver provides its CDU with analog gimbal-angle signals that represent a component of LEM attitude. The CDU's convert these signals to digital form and apply them to the LGC. The LGC uses this data to calculate attitude and translation commands, which are routed to the RCS. The LGC generates steering-error signals, which are converted to 800-cps analog signals and applied to the attitude indicators in the Controls and Displays Subsystem. In addition, the CDU's couple coarse-align commands generated by the LGC to the IMU.

The digital-to-analog converters of the CDU's are a-c ladder networks. When a CDU is used to position a gimbal, the LGC calculates the difference between the desired gimbal angle and the actual gimbal which has accumulated in the CDU. The accumulation of increments results in a servo error signal that drives the gimbal to the desired angle.

The analog-to-digital converter operates on an incremental basis. Using a digital-analog feedback technique which uses the resolvers as a reference, the CDU accumulates the proper angle value by accepting increments of the angle to close the feedback loop. These data are applied to counters in the LGC for RR tracking information, and to counters in the LGC and the abort electronics assembly (AEA) for IMU gimbal angles. In this manner, the AGS attitude reference is fine-aligned simultaneously with that of the PGNS.

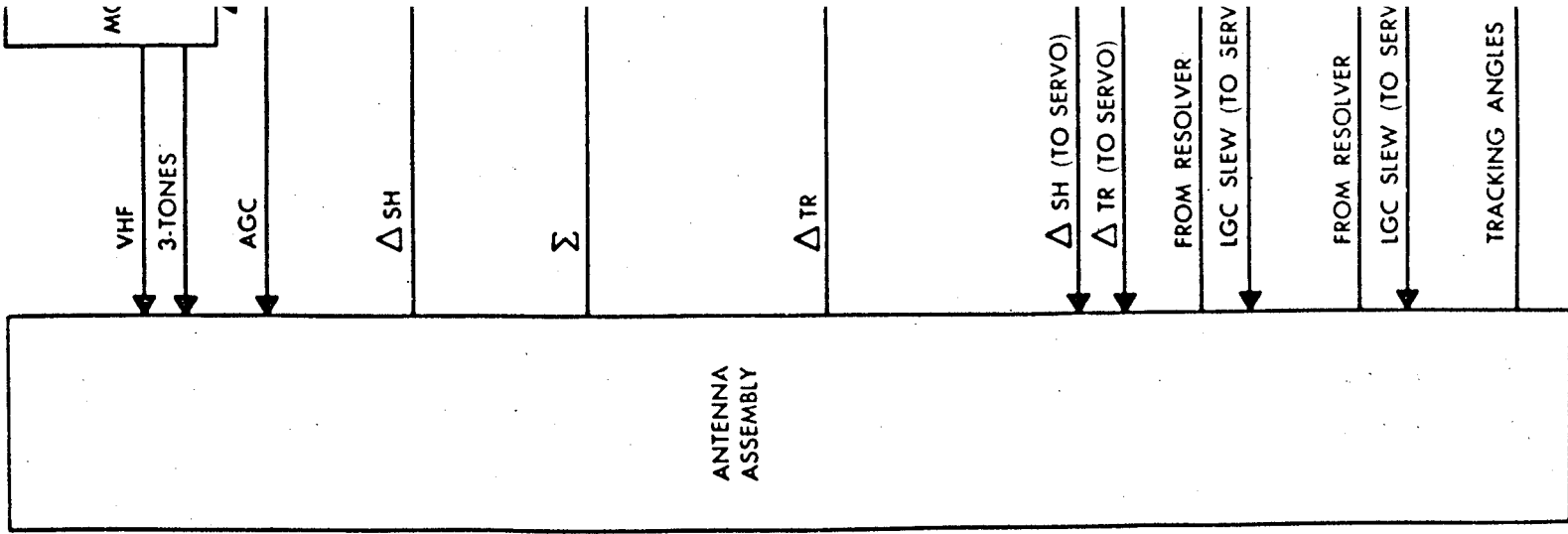

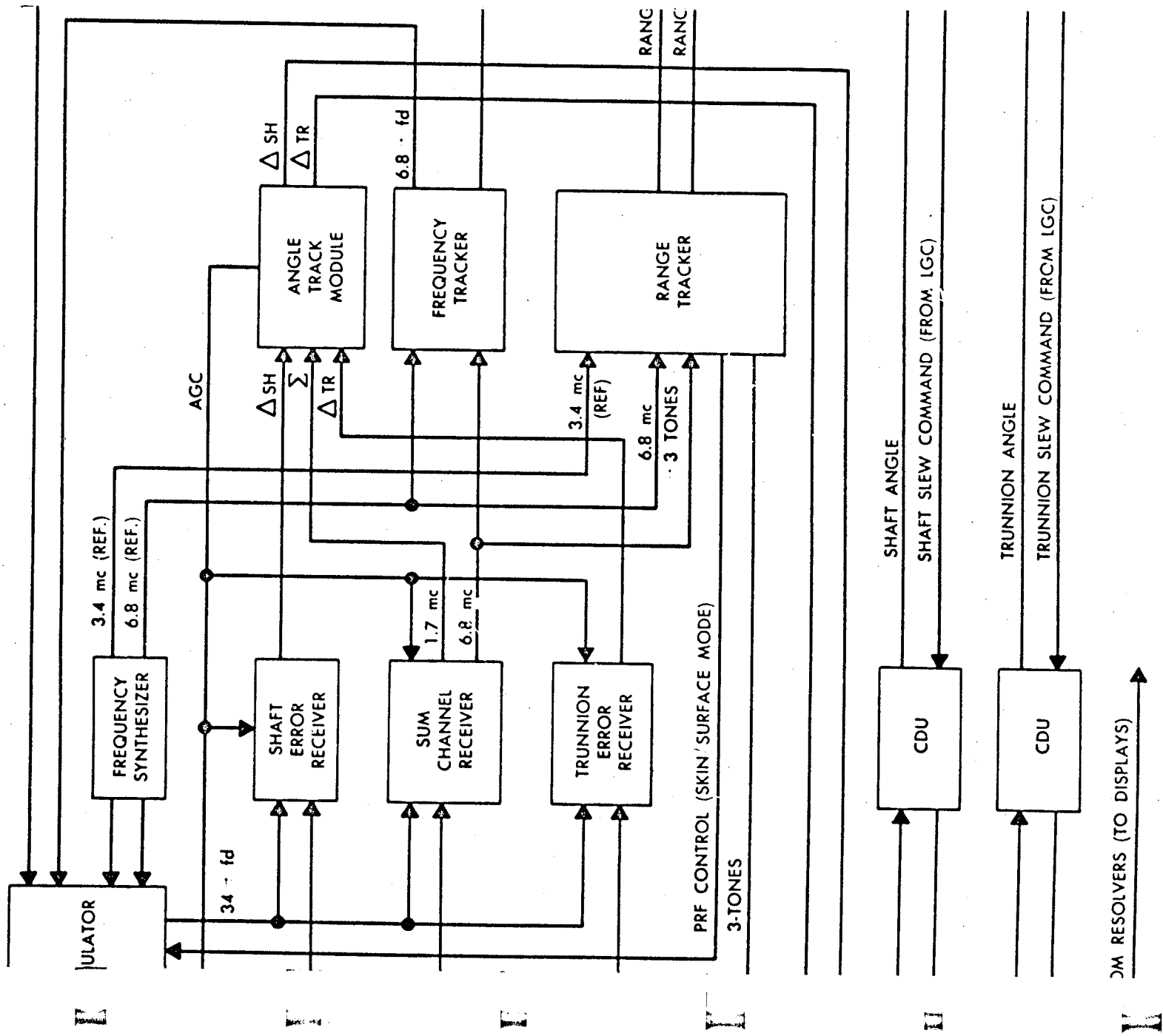

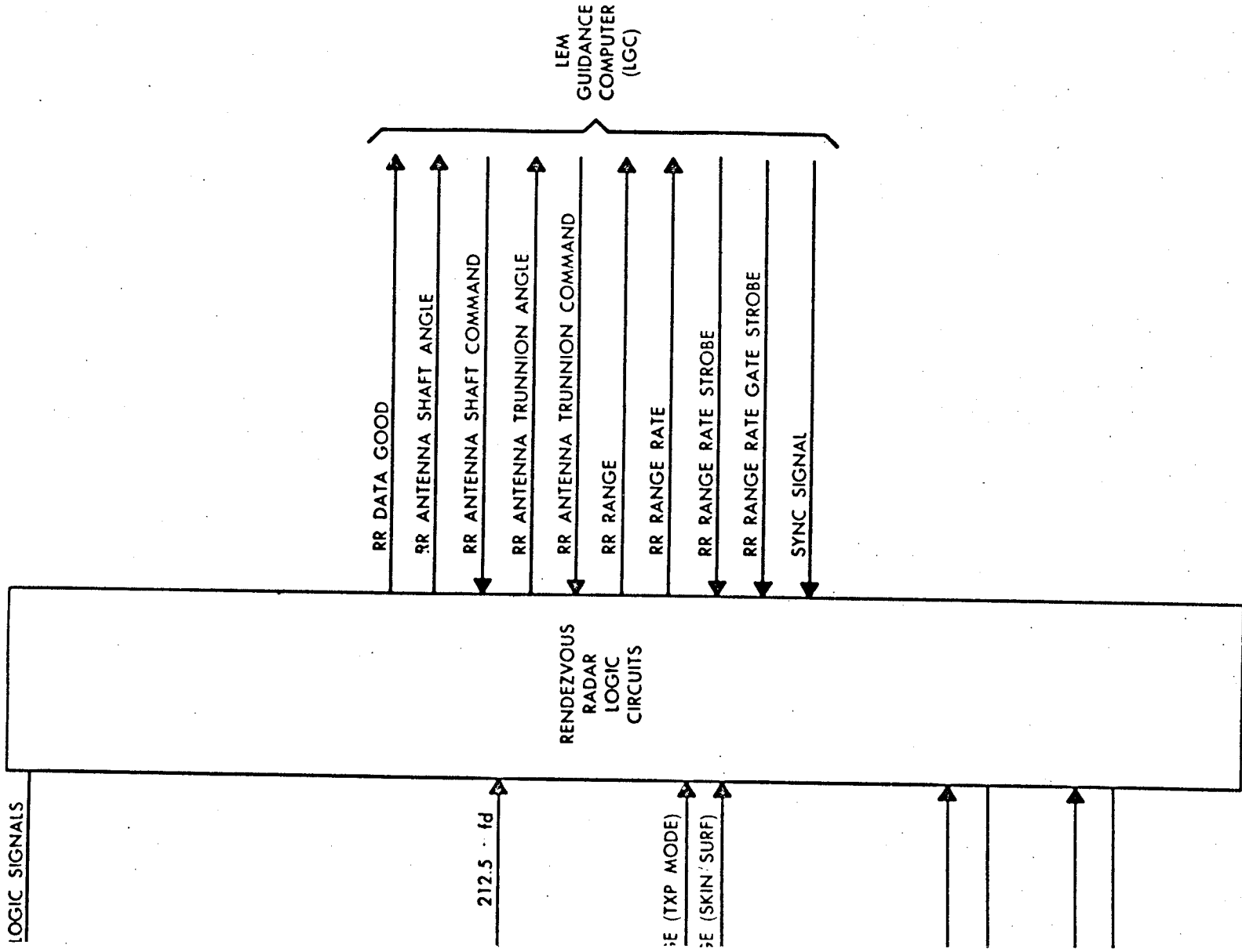

Figure 3-8. Rendezvous Radar Block Diagram

3-43. LEM Guidance Computer.

The LEM guidance computer (LGC) is the central data-processing device of the GN & C Subsystem. It is a parallel, fixed-point, one's-complement, general-purpose digital computer with a fixed rope core memory and an erasable ferrite core memory. It has a limited self-check capability. Inputs to the LGC are received from the LR and RR, from the IMU through the CDU's and from an astronaut via the data entry keyboard on the primary guidance and navigation panel. The LGC performs four major functions: (1) calculates steering signals and generates engine and RCS jet commands to keep the LEM on a required trajectory, (2) aligns the stable member (innermost gimbal) of the IMU to a coordinate system defined by precise optical measurements, (3) conducts limited malfunction isolation of the GN & C Subsystem, and (4) computes pertinent navigation information for display to the astronauts. Using information from navigation fixes, the LGC determines the amount of deviation from the required trajectory and calculates the necessary attitude and thrust corrective commands. Velocity corrections are measured by the IMU and controlled by the LGC. During coasting phases of the mission, velocity corrections are not made continuously, but are initiated at predetermined checkpoints.

The LGC memory consists of an erasable and a fixed magnetic core memory with a combined capacity of 38,912 16-bit words. The erasable memory is a coincident-current, ferrite core array with a total capacity of 2,048 words; it is characterized by destructive readout. The fixed memory consists of three magnetic-core rope modules. Each module contains two sections; each section contains 512 magnetic cores. The capacity of each core is 12 words, making a total of 36,864 words in the fixed memory. Readout from the fixed memory is nondestructive.

The logic operations of the LGC are mechanized using micrologic elements, in which the necessary resistors and transistors are diffused into single silicon wafers. One complete NOR gate, which is the basic building block for all LGC circuitry, is in a package the size of an aspirin tablet. Flip-flops, registers, counters, etc. are made from these standard NOR elements in different wiring configurations. The LGC performs all necessary arithmetic operations by addition, adding two complete words and preparing for the next operation in approximately 24 microseconds. To subtract, the LGC adds the complement of the subtrahend. Multiplication is performed by successive additions and shifting; division, by successive addition of complements and shifting.

3-44. Power and Servo Assembly. The power and servo assembly (PSA) provides a central mounting place for most of the PGNS amplifiers, modular electronic components, and power supplies. The PSA comprises the following subassemblies: gimbal servo align and power amplifiers, gyro and accelerometer amplifiers and electronics, CDU electronics, power diodes and signal conditioners, and power supplies. A cold plate, through which water-glycol coolant from the Environmental Control Subsystem flows, is mounted under the PSA subassemblies to dissipate heat.

3-45. ABORT GUIDANCE SECTION. (See figure 3-9.)

The abort guidance section (AGS) consists of an abort sensor assembly (ASA) which can sense accelerations along, and angular rates of motion about the LEM axes; an abort electronics assembly (AEA), which fulfills all the computational requirements of the AGS; and a data entry and display assembly (DEDA). The DEDA uses manually entered information to control the AGS modes of operation, to insert data into the AEA, and to command the contents of a desired AEA memory core to be displayed on the DEDA.

Two functions are provided by the AGS; abort capabilities during any phase of the LEM mission, and an inertial reference frame which can be used as an attitude reference for LEM stabilization during any phase (including abort) of the LEM mission. The AGS generates engine on-off commands, and LEM attitude error signals that, after passing through the CES, actuate appropriate RCS thrusters.

The AGS has three modes of operation: off mode, standby mode, and operate mode.

3-46. Off Mode. The off mode prepares the AGS for operation 30 minutes after entering this mode.

3-47. Standby Mode. The standby mode prepares the AGS to enter the AGS alignment mode after a 25-minute period. In this mode, the AGS accepts PGNS alignment information after 20 seconds of elapsed time.

3-48. Operate Mode. The operate mode incorporates the alignment mode and the inertial reference mode. Selection of the desired mode is controlled by manually inserting the proper commands into the DEDA.

- Alignment Mode. The alignment mode has three submodes: IMU alignment, body axis alignment, and lunar alignment of the AGS. Alignment of the IMU is accomplished by setting the AGS inertial reference to the calculated value of the PGNS inertial refer-

ence which is obtained from IMU gimbal angle information. Body axis alignment is accomplished by setting the AGS inertial reference coincident with the LEM body axis. Lunar alignment is accomplished by using the stored AGS azimuth information or the PGNS azimuth angle information depending upon whether the PGNS malfunctions prior to or after lunar touchdown. The local vertical information is obtained from the ASA accelerometers.

- Inertial Reference Mode. The inertial reference mode has three submodes, namely the rendezvous, attitude hold, and CSM acquisition submodes. In the rendezvous submode, the AGS provides the steering and ΔV commands necessary for rendezvous with the CSM. The attitude hold submode functions so that the commanded attitude of the vehicle is maintained by activating the attitude commands generated by the AGS. In the CSM acquisition submode, the Z-axis of the LEM is directed toward the CSM by applying the attitude commands generated by the AGS.

3-49. Abort Sensor Assembly. The abort sensor assembly (ASA) is a strap-down inertial sensor package that contains three gyroscopes, three accelerometers, and the associated electronics and power supply. The ASA, the IMU, and the AOT are mounted on a navigation base. The ASA is mounted so that its coordinate axes correspond to the X-, Y-, and Z-axis. The outputs of the gyroscopes and accelerometers represent incremental angles and incremental velocity. These data are applied to the abort electronics assembly for direction cosine, guidance, navigation, and steering calculations, and for conversion to Euler angles for display.

3-50. Abort Electronics Assembly. The abort electronics assembly (AEA) is a 4096-word, general-purpose digital computer. It uses data manually entered by the astronauts and gyro and accelerometer data from the ASA to perform basic strap-down calculations and all necessary abort guidance, navigation and steering control, and display-quantity calculations. The three CDU's that function primarily as interfaces between the IMU and the LGC apply IMU gimbal-angle data simultaneously to the LGC and the AEA. This ensures that the abort guidance attitude reference is aligned simultaneously with that of the PGNS. The data entry and display assembly (DEDA) enables the astronauts to enter data into the AEA and to command various displays.

3-51. CONTROL ELECTRONICS SECTION. (See figure 3-10.)

The control electronics section (CES) consists of a control panel, an attitude and translation control assembly (ATCS), a descent engine control assembly (DECA), two gimbal drive actuator assemblies (GDA's), two thrust translation controller assemblies (TTCA's) two attitude controller assemblies (ACA's), and a rate gyro assembly (RGA). The CES provides signals to fire any combination of the 16 thrusters in the Reaction Control Subsystem (RCS) to stabilize the LEM vehicle during all phases of the mission. These signals control the LEM attitude and translation about or along all axes during the LEM mission. The attitude and translation control data inputs originate from the PGNS during normal automatic operation, from the ACA and TTCA during manual operations, or from the AGS in an abort situation. The CES converts attitude error signals, rate commands, or translation commands into pulse-ratio-modulated pulsed or full-on signals for firing the appropriate RCS thrusters. In addition, rate and attitude error signals from the CES are displayed on the flight director attitude indicator. The CES also processes on-off commands for the ascent and descent engines, and routes automatic and manual throttle commands to the descent engine. Trim control of the gimballed descent engine is also provided to assure that the thrust vector operates through the LEM center of gravity.

3-52. Attitude Control. There are two normal CES modes of operation of the LEM: automatic and attitude hold. In addition to these two modes, a pulsed mode, a two-jet direct mode, and a four-jet manual override mode are available. Either of the two normal modes of operation may be selected by setting the MODE SELECT switch on the stabilization and control panel to the proper position (see figure 3-2). The pulse mode and two-jet direct mode are selected on the same panel, on a single-axis basis. The manual override mode of operation is always available. The pulse submode and direct mode are used only in the abort guidance mode. The +X axis translation command is automatically accomplished by the LGC when the primary guidance path is in operation. When the abort guidance path is in operation, and the X-TRANSL switch on the control panel is pushed, it provides an override of +X-axis translation data direct to the RCS secondary solenoids.

3-53. Thrust Translation Controller Assemblies. The thrust translation controller assemblies (TTCA's) are three-axis, T-handle, hand controllers used by the astronauts to command LEM translation and to throttle the descent engine between 10% and 100% of maximum thrust. A manually operated lever on the TTCA enables the astronaut to select either of two control functions: to control translation in the Y-axis and Z-axis and throttling of the descent engine; to control translation in all three axes. Left or right movements of the T-handle commands translation along the Y-axis, fore or aft movement commands translation along the Z-axis, and up or down movement commands translation along the X-axis or throttling of the descent engine.

ABORT ELECTRONICS ASSEMBLY (AEA)

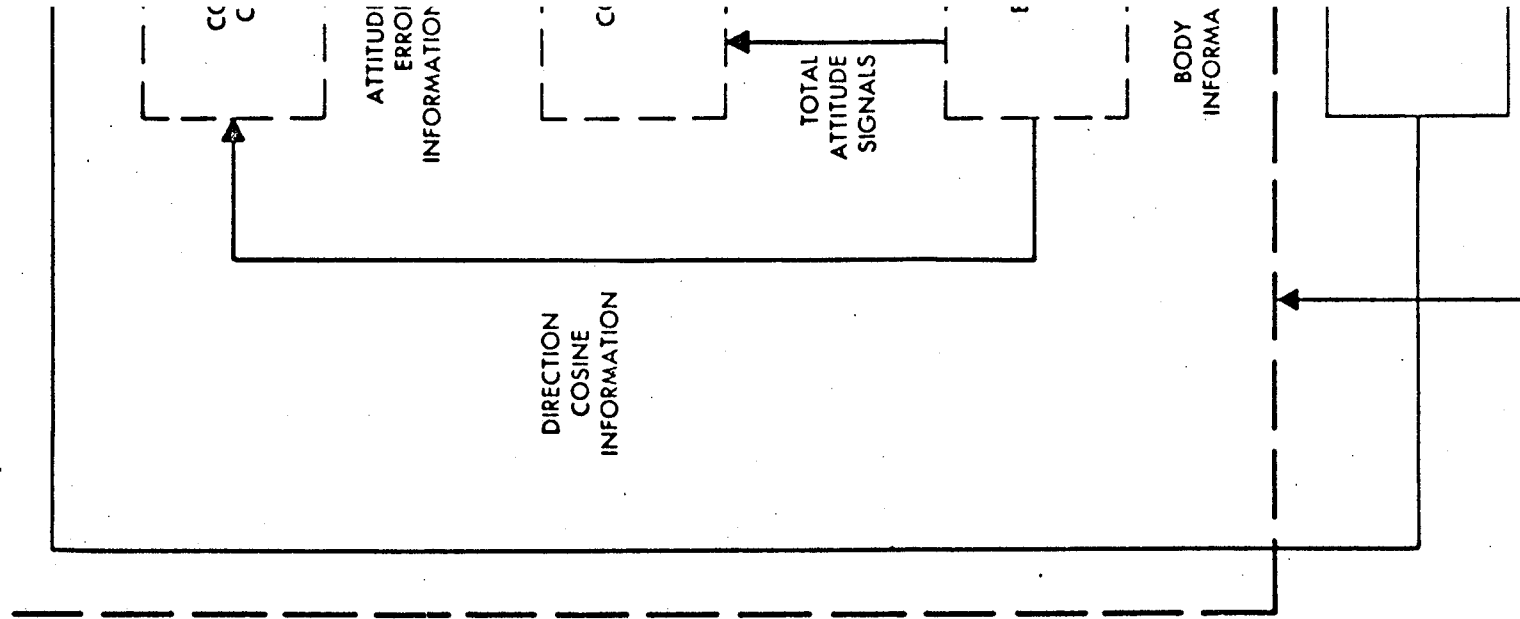

BODY ATTITUDE ERROR SIGNALS

ORDINATE
INVERTER

MODE SELECT COMMANDS

MODE SELECT

MANUAL OR ALIGNMENT COMMANDS

CONTROL AND
ALIGNMENT
LOGIC

ABORT SIGNAL

COMMAND SIGNAL

ROLL ANGLE
GENERATOR

DATE
ON

ABORT
TRAJECTORY
COMPUTATION
CIRCUIT

BODY ACCELERATION INFORMATION

ABORT
SENSOR
ASSEMBLY
(ASA)

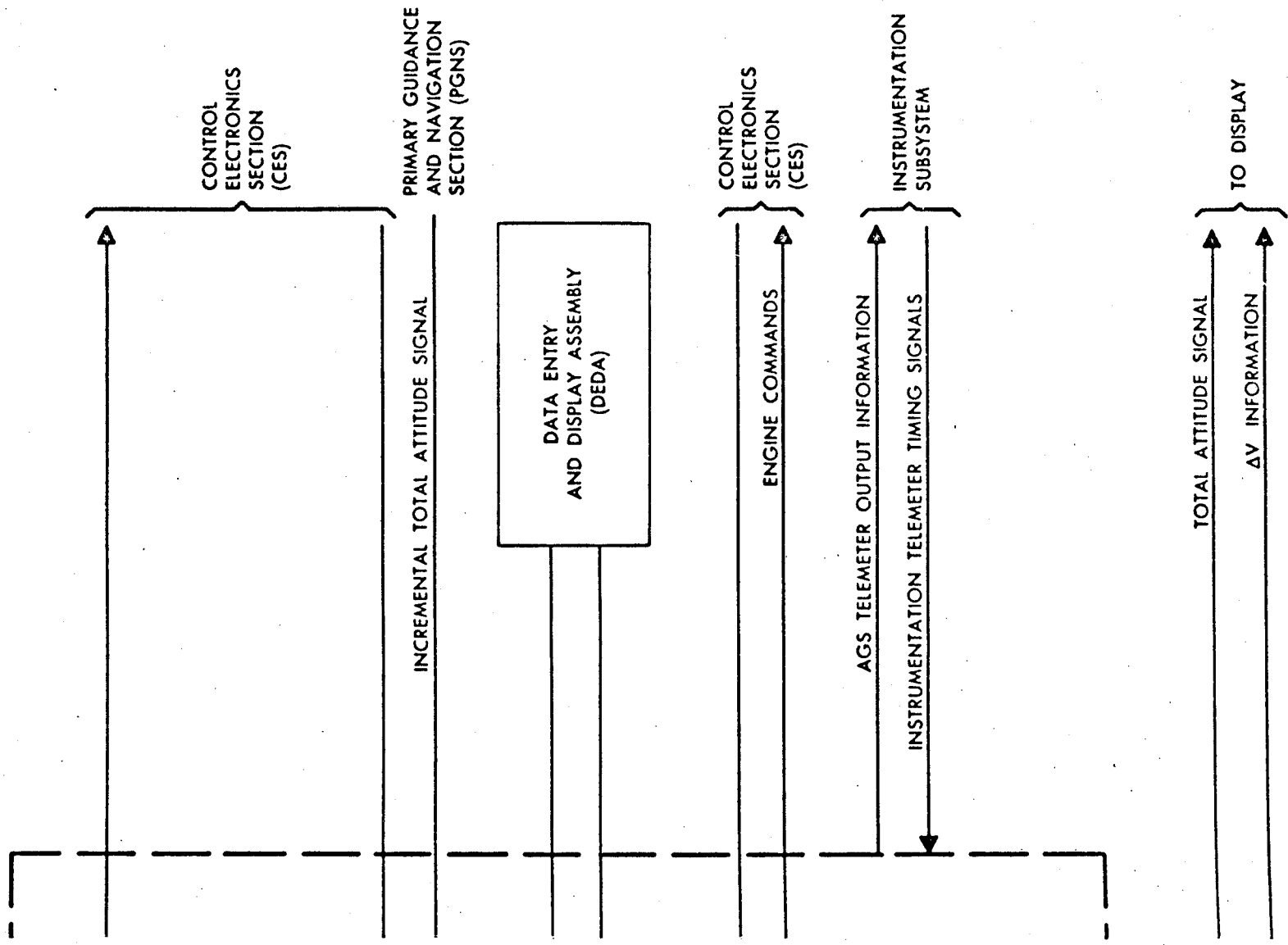

Figure 3-9. Abort Guidance Section Block Diagram

TO
ELECTROEXPLOSIVE
DEVICES

ENGINE-ON AND
ENGINE-OFF
COMMAND PULSES

ENGINE-ON AND
ENGINE-OFF
COMMAND PULSES

ABORT
ELECTRONICS
ASSEMBLY

LEM GUIDANCE
COMPUTER (LGC)

ASCENT ENG
AND SEQUE

ENGINE-ON AND
ENGINE-OFF
COMMANDS

THRITTLE COMMANDS

LEM GUIDANCE
COMPUTER (LGC)

TRIM COMMANDS

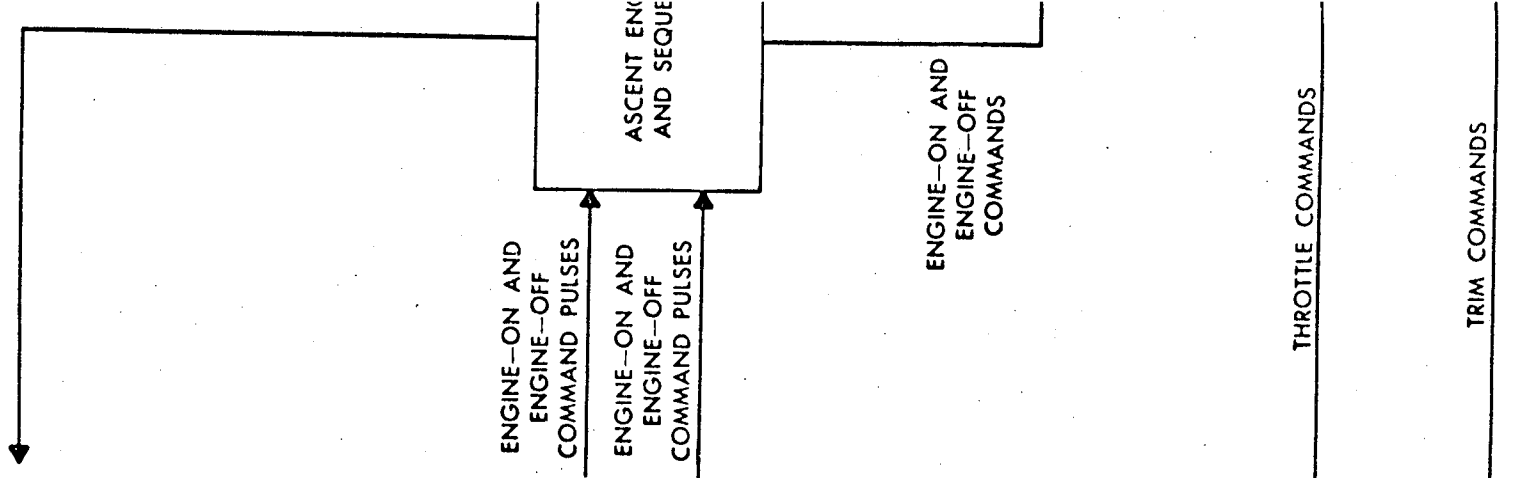

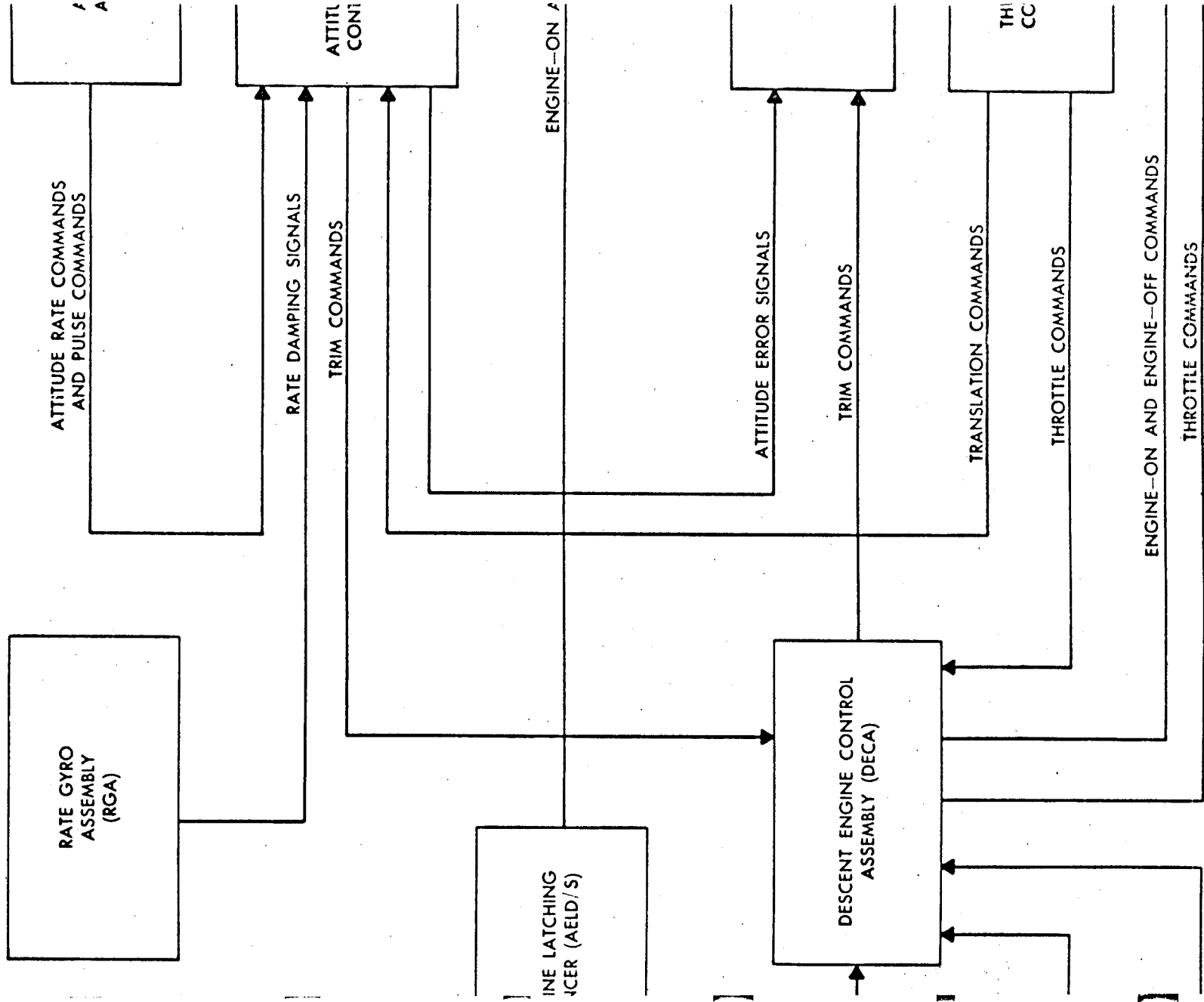

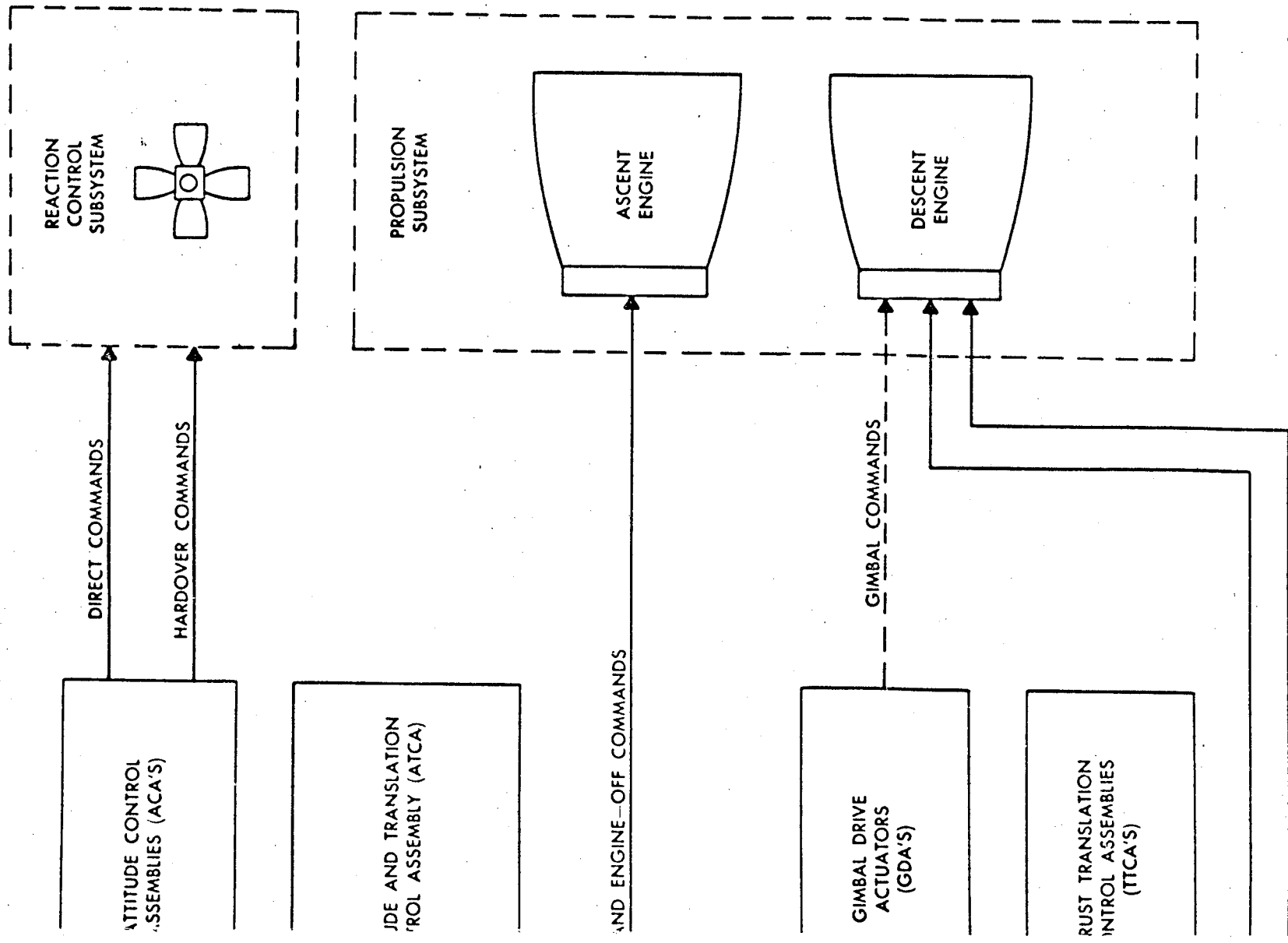

Figure 3-10. Control Electronics Section Block Diagram

3-54. Descent Engine Control Assembly. The descent engine control assembly (DECA) provides regulation and control of the descent engine. It accepts throttle commands from the LGC and the TTCA, engine-on and engine-off commands from the AELD/S, and trim commands from the LGC or the ATCA. Conversion of these inputs to descent-engine commands is performed by demodulators, comparators, and counters in the DECA, which also includes automatic trim-malfunction logic that detects gimbal motor failures and removes power from the corresponding GDA when a failure occurs. The DECA applies throttle commands and engine-on and engine-off commands to the descent engine, and routes trim commands to the GDA's.

3-55. Gimbal Drive Actuators. Two gimbal drive actuators (GDA's) are used with the descent engine: one tilts the engine $\pm 6^\circ$ about the Y-axis; the other tilts the engine $\pm 6^\circ$ about the Z-axis. The GDA's are low-speed actuators used to trim the descent engine only when the thrust vector of the descent engine does not pass through the LEM center-of-gravity.

3-56. Attitude Controller Assemblies. The attitude controller assemblies (ASA's) are three-axis, pistol-grip hand controllers that are used by the astronauts to command changes in LEM attitude. Each ACA is installed with its longitudinal axis parallel to the LEM X-axis; LEM attitude changes correspond to movements of the pistol grip. Clockwise or counterclockwise movements of the pistol grip causes attitude changes about the X-axis, fore or aft movement causes attitude changes about the Y-axis, and left or right movement causes attitude changes about the Z-axis. A position-sensing transducer, a pair of detent (breakout) switches, and a pair of limit switches are installed about each axis of the ACA. The transducers provide attitude rate command signals that are proportional to the ACA displacement. The detent switches provide pulsed or direct firing of the RCA jets when either corresponding mode of operation is selected. The limit switches are wired to the secondary solenoids of the RCS jets. These switches provide the hardover commands that override the automatic attitude control signals from the ATCA.

3-57. Rate Gyro Assembly. The rate gyro assembly (RCA) contains three subminiature single-degree-of-freedom gyroscopes that are mounted to sense LEM roll, pitch, and yaw rates. The outputs of the gyroscopes are used by the ATCA as rate-damping signals.

3-58. Ascent Engine Latching Device and Sequencer. The ascent engine latching device and sequencer (AELD/S) receives engine-on and engine-off commands for the ascent and descent engines from the LGC or the AEA. These commands are in a digital-pulse format. The AELD/S converts these commands to sustained engine-on or engine-off signals and applies them to the ascent engine or the DECA, in addition to supplying the power required by the engine solenoid valves. If the LEM mission is aborted in the descent phase, the AELD/S causes the descent engine to be turned off, routes relay-closure signals to the electroexplosive device for staging, and causes the ascent engine to be turned on. In addition, a signal is routed to the ATCA which selects minimum deadband and four-jet RCS operation.

3-59. Attitude and Translation Control Assembly. The attitude and translation control assembly (ATCA) controls LEM attitude and translation motions. In the primary guidance path, attitude and translation commands are generated by the LGC and applied directly to the ATCA jet drivers. In the abort guidance path, the ATCA receives translation commands from the TTCA, rate-damping signals from the RGA, and attitude rate commands and pulse commands from the ACA. The ATCA sums, amplifies, limits, demodulates, or dead-bands these signals to produce the appropriate thruster-on and thruster-off commands. The ATCA combines attitude and translation commands in its logic network to select the pulse ratio modulators and jet-solenoid drivers that accomplish the desired combination of translation and rotation. The dead-band circuitry of the ATCA controls the LEM limit-cycle range. The attitude error signals generated by the ATCA are applied to the GDA's during operation in the abort guidance path.

3-60. REACTION CONTROL SUBSYSTEM.

The Reaction Control Subsystem (RCS) provides small rocket thrust impulses to stabilize the LEM during descent and ascent, and to control the LEM attitude and translation about or along all axes during hover, rendezvous, and docking maneuvers. The RCS consists basically of 16 thrust chamber assemblies supplied by two separate propellant pressurization and supply sections. The thrust chambers and the dual propellant pressurization and supply sections make up two parallel, independent systems (A and B), as shown in figures 3-11 and 3-12. The 16 thrust chamber assemblies are mounted in clusters of four; the clusters are equally spaced around the LEM ascent stage, and are numbered I, II, III, and IV, as shown in figure 3-11. The individual thrust chamber assemblies in each cluster are identified as u, d, s, and f (up, down, side, and fore-aft). The arrangement is such that two of the thrust chamber assemblies in each cluster are mounted parallel to the vehicle's X-axis, facing in opposite directions (up and down); the other two are spaced 90° apart (one facing to the side, and the other facing forward or aft) in a plane normal to the X-axis. Two thrust chamber assemblies in

each cluster are supplied by system A; the other two by system B. Normally, both systems are operated simultaneously; however, the variation in systems A and B orientation in each cluster is such that complete control on all axes is possible despite a failure in either system. A schematic diagram of the RCS is shown in figure 3-12.

3-61. PROPELLANTS.

The RCS uses hypergolic propellants consisting of a 50-50 fuel mixture of hydrazine (N_2H_4) and unsymmetrical dimethylhydrazine (UDMH), with nitrogen tetroxide (N_2O_4) as the oxidizer. The mixture ratio of oxidizer to fuel is 2 to 1 by weight. The same propellants are used in the LEM ascent and descent propulsion subsystems.

3-62. PROPELLANT PRESSURIZATION AND SUPPLY SECTIONS.

The propellant pressurization and supply sections in each of the systems (A and B) include all of the propellant storage, pressurization, and feed components necessary for delivery of fuel and oxidizer to the thrust chamber assemblies. Each system has two cylindrical tanks (one for fuel and one for oxidizer) with hemispherical ends. The propellants are contained in positive expulsion bladders supported by standpipes that run lengthwise through each tank. Both tanks in each of the dual supply sections are pressurized by an individual helium supply that acts upon the tank bladders to force fuel and oxidizer into a manifold that supplies the eight thrust chambers of the related system.

Each helium supply is stored in a spherical tank at a pressure of 3,000 to 3,100 psi. Two parallel, explosive-operated (squib) valves seal off the supply until they are fired for the initial RCS start. Downstream of the squib valves, the helium passes through a filter and the supply line is divided into parallel legs, each containing two pressure regulators in series. The pressure regulators reduce the helium pressure to approximately 180 psi. Solenoid valves (one in each leg immediately downstream of the pressure regulators) are operated so that only one leg of the regulator set is opened at a time. If the normally open leg malfunctions, it can be closed off and the parallel leg opened.

The helium supply then branches into oxidizer tank and fuel tank pressurization lines, with a quadruple check valve set and a pressure relief assembly in each. The relief valve is set at approximately 250 psi and prevents the possibility of a catastrophic system overpressurization if the regulator set fails completely. A burst disk in the pressure relief assembly is set to rupture at a slightly lower pressure than that necessary to crack the relief valve, to ensure against possible helium leakage through the relief valve during normal operation. A filter (between the burst disk and the relief valve) retains burst disk fragments.

Normally open solenoid valves in the outlet lines of the propellant tanks can be closed to isolate the propellant supply if a malfunction occurs. If an overpressurization should occur in system A, for instance, the helium supply may be lost and the system A propellant supply would then have to be isolated by closing the solenoid valves (9 and 10, figure 3-12). If one propellant supply must be shut down in this manner, normally-closed solenoid valves (14 and 17, figure 3-12) in a crossfeed piping arrangement between the system A and system B propellant manifolds can be opened to provide propellant flow from the remaining propellant supply to all 16 thrust chamber assemblies.

In addition, there are similar solenoid valves (13, 15, 16, and 18, figure 3-12) in feed lines that connect the RCS manifolds and the ascent propulsion propellant supply lines for the transfer of ascent engine propellant to the RCS propellant supply (during positive X-axis thrusting only) if needed.

To prevent possible propellant loss through a malfunctioning thrust chamber assembly or a damaged cluster, solenoid-operated valves (1 through 8 and 23 through 30, figure 3-12) in the propellant manifolds just upstream of each cluster can be closed to isolate either the A or B portions, or the entire cluster, as required.

3-63. PROPELLANT QUANTITY GAGING EQUIPMENT.

A nucleonic quantity gaging system with a cobalt 60 radioisotope source is used to determine the propellant quantity in the RCS positive expulsion bladders, and is functional under all conditions, including zero gravity. The system consists of sensor units (on the four propellant tanks) linked to a solid-state digital computer. The sensors register the quantity of propellant in each tank and transmit this data to the computer as a variable frequency. The computer converts this frequency into a percentage of the initial propellant supply and calculates the remaining mass ratio. A digital quantity readout is then displayed on the appropriate panel. An additional signal is also transmitted to the caution and warning lights if the propellant mass ratio exceeds a preset range.

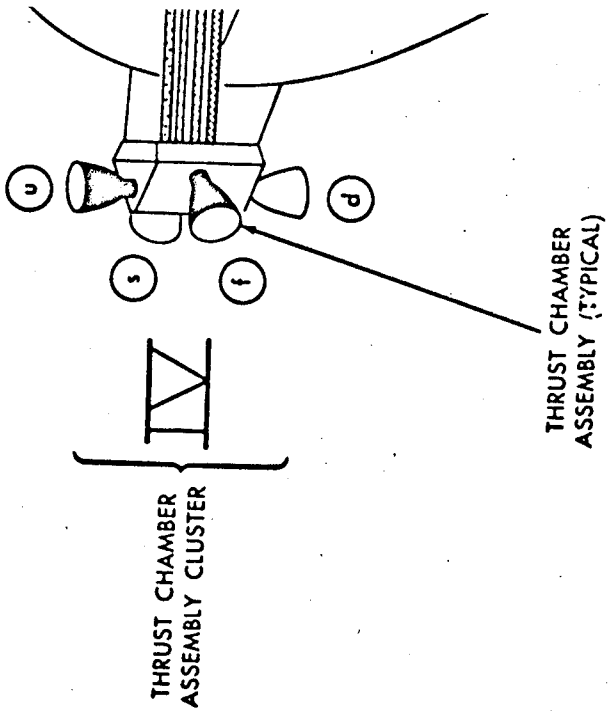

AXES ORIENTAT

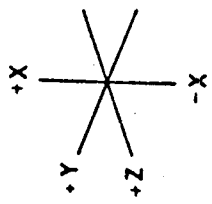

HELIUM PRESSURE
INSULATING PACKAGE

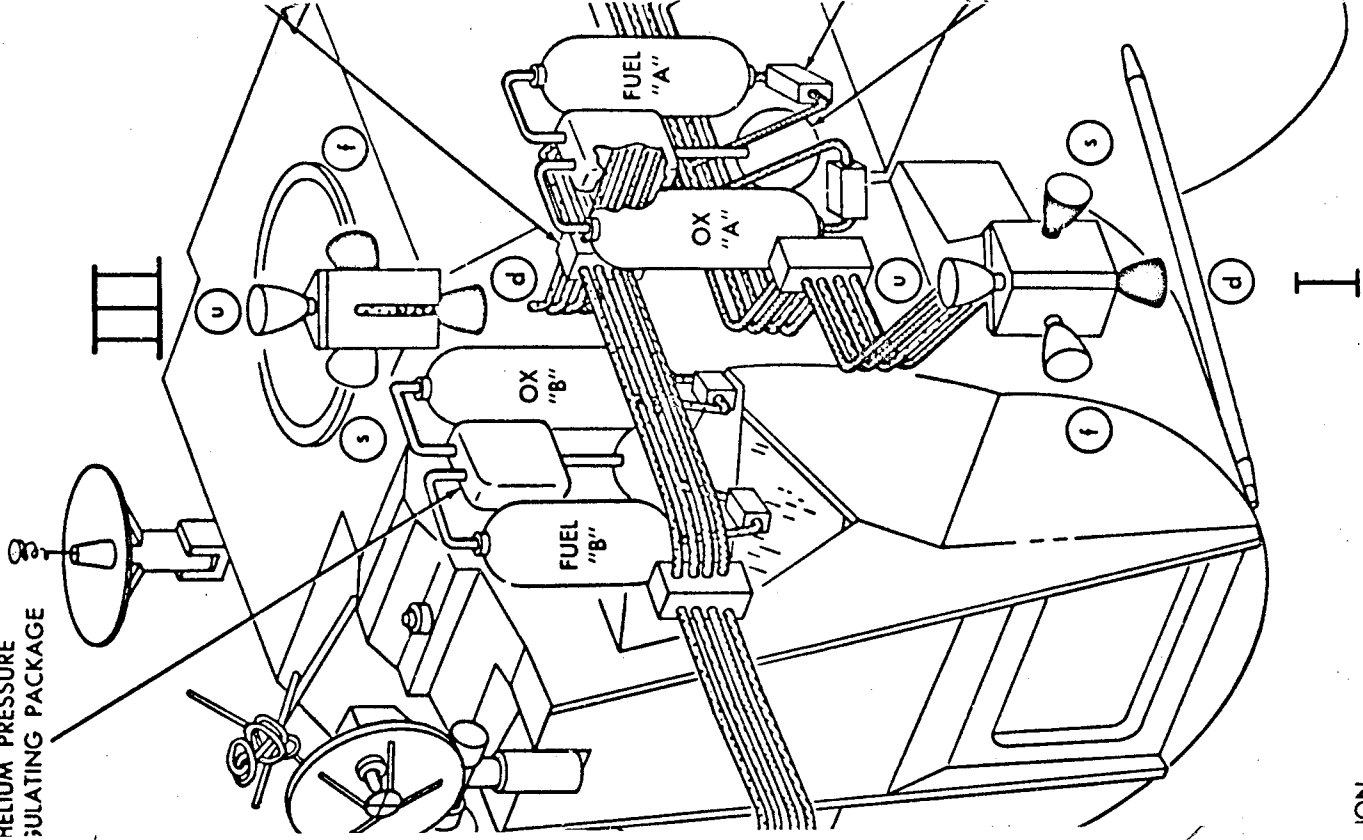

FUEL "A"
OXIDIZER "A"
FUEL "B"
OXIDIZER "B"

Figure 3-11. Rea

15 October 1965

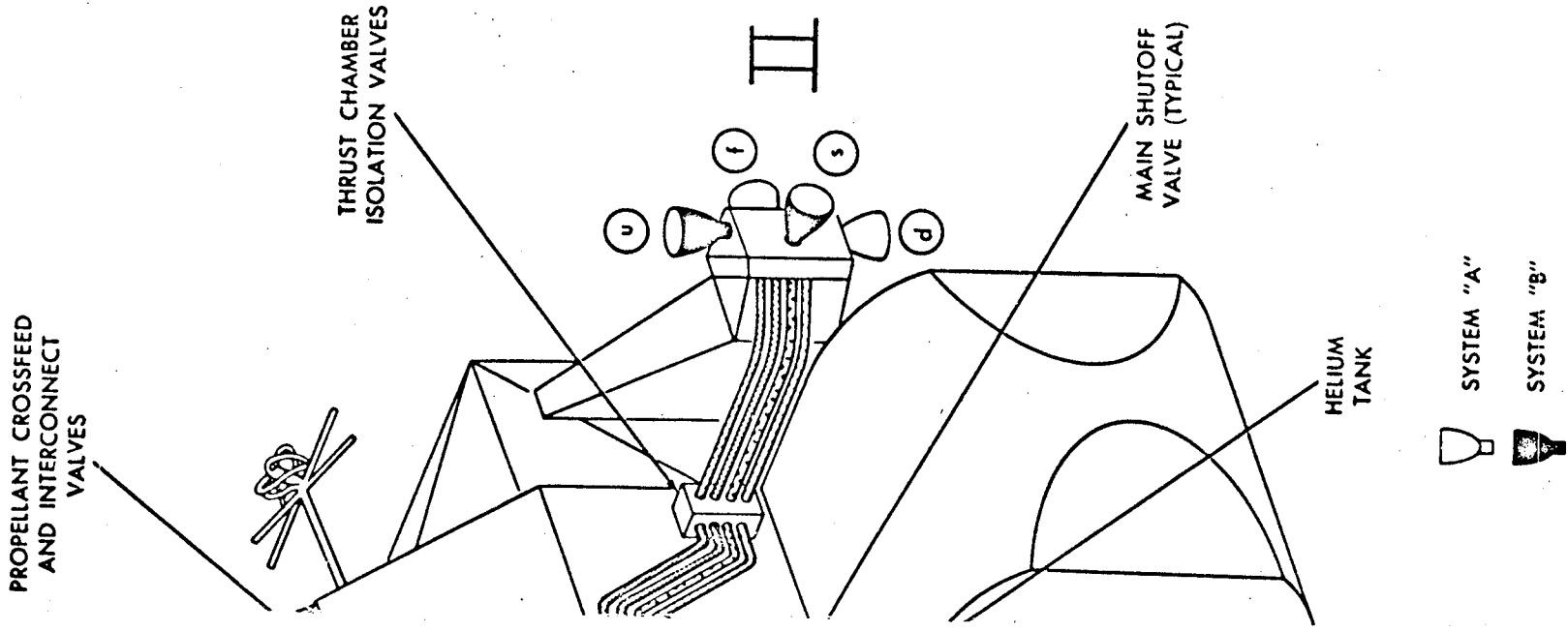

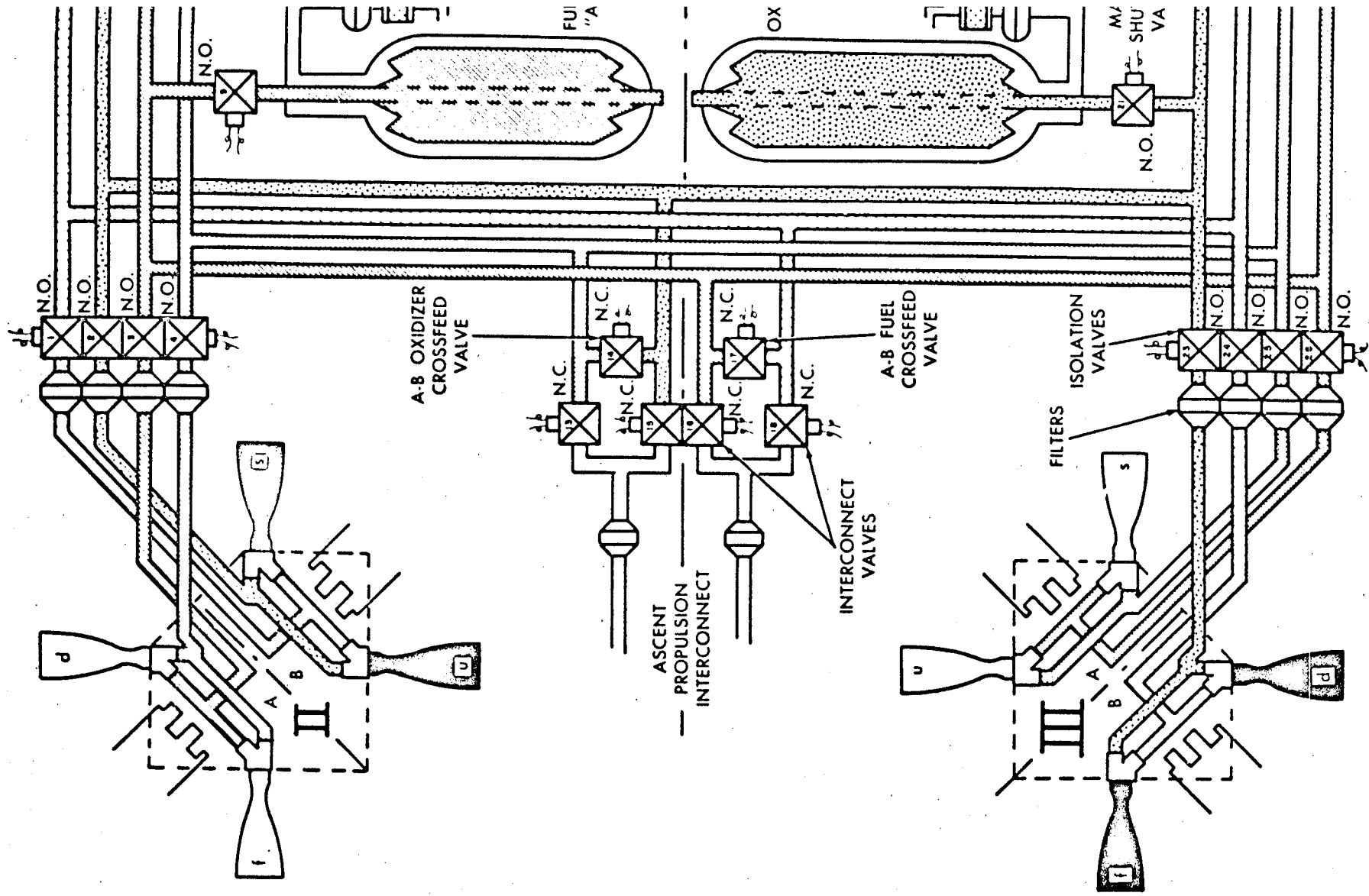

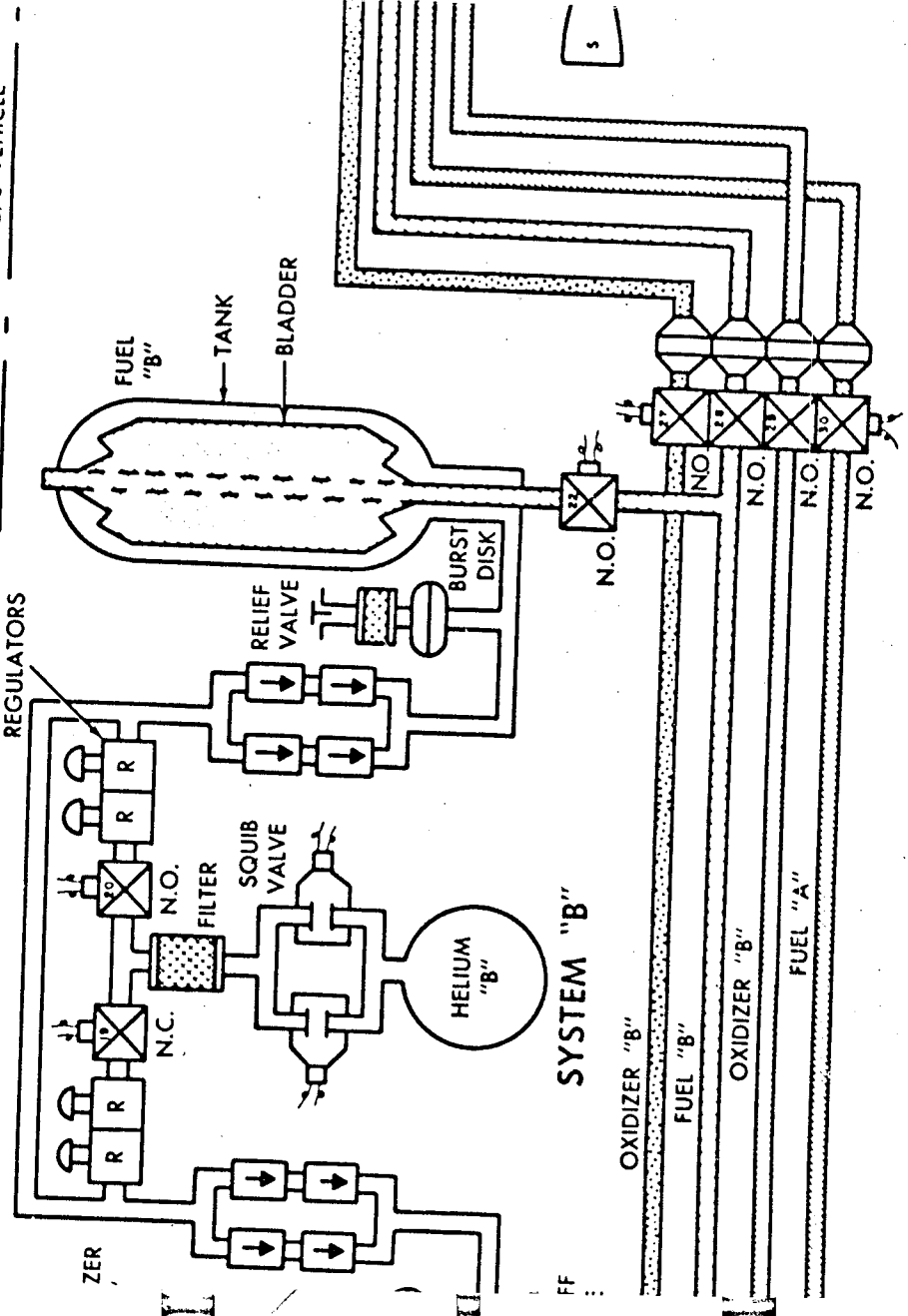
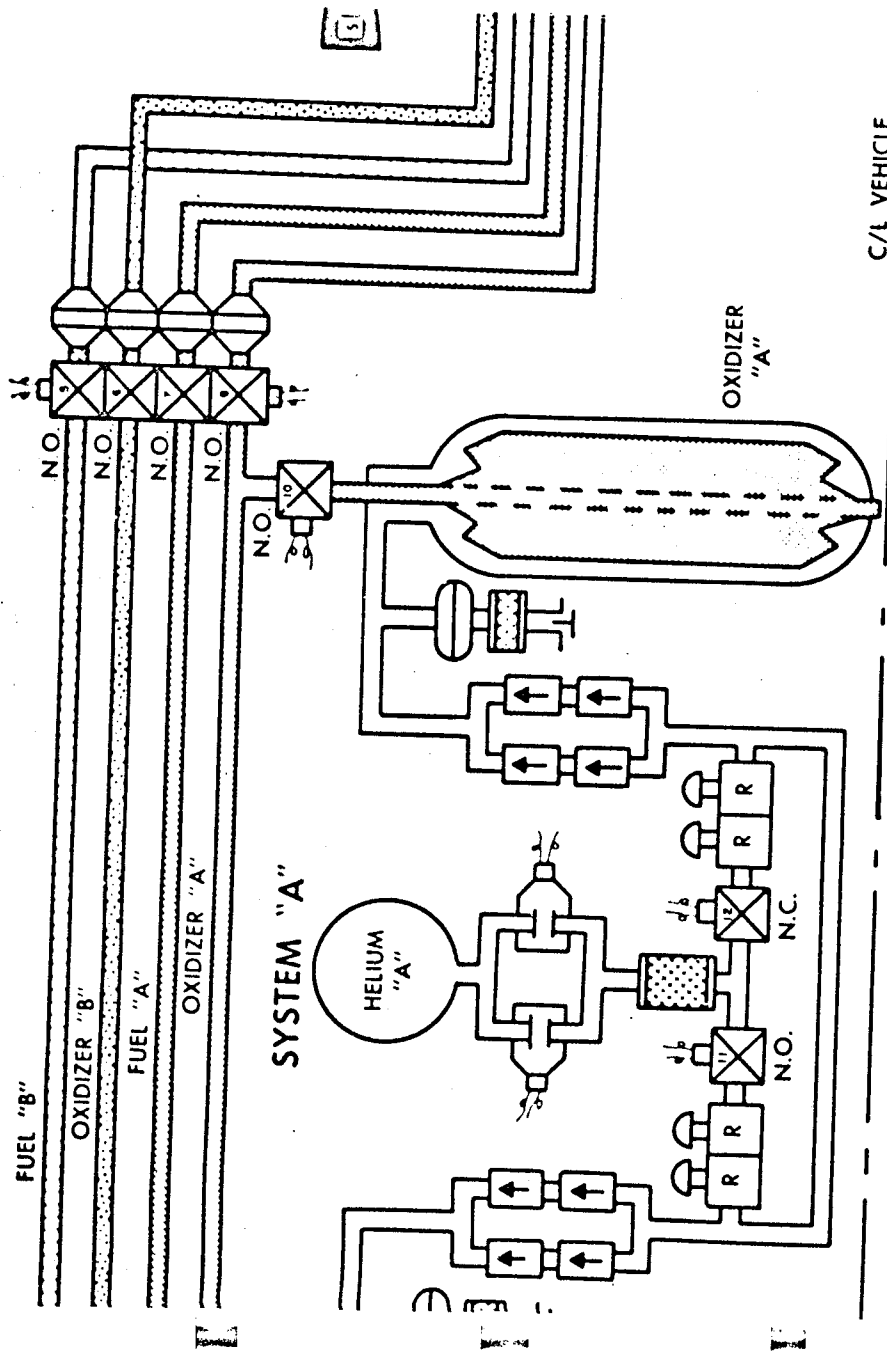

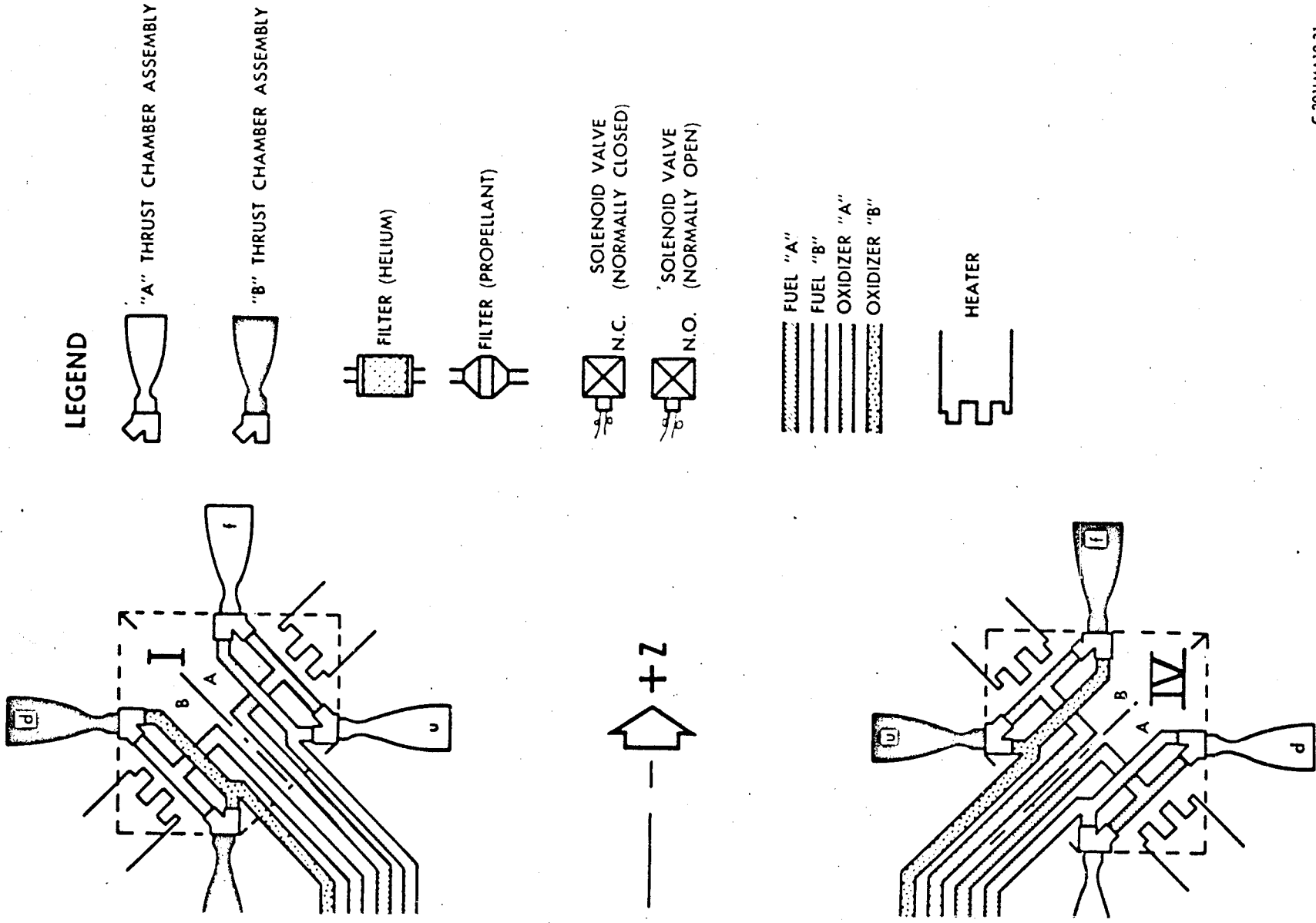

Figure 3-12. Reaction Control Subsystem Schematic

3-64. THRUST CHAMBER ASSEMBLIES. (See figure 3-13.)

Each thrust chamber assembly is a small rocket engine that develops 100 pounds of thrust and is capable of either pulse-mode or steady-state operation. The engine consists primarily of a combustion chamber and nozzle, an injector assembly, and separate fuel and oxidizer solenoid valves. Fuel and oxidizer are piped through the cores of the solenoid valves, the armatures of which are normally seated on the injector inlets to close off flow to the combustion chamber. When the "engine-on" signal is received, both solenoids are energized to lift the armatures from their seats.

During the first instant of the engine start sequence, the initial flow passes through jets to doublet orifices in a preigniter cup, where the initial combustion occurs to minimize overpressurization or "spiking". The fuel flow then passes through an annulus to fuel orifices; oxidizer passes into oxidizer orifices that surround the preigniter cup. These orifices are also arranged in doublets (at angles to each other) so that the emerging fuel and oxidizer streams impinge, completing the engine start. Additional flow is provided from the fuel annulus to orifices that spray fuel on the inner wall of the combustion chamber and around the outer periphery of the preigniter cup for cooling purposes.

Each thrust chamber assembly cluster has two electrically-operated heaters that warm the cluster structure to prevent freezing of the thrust chamber assemblies during the lunar stay.

3-65. RCS OPERATIONAL MODES.

Each thrust chamber assembly solenoid valve (fuel and oxidizer) contains parallel-connected primary coils and series-connected secondary coils. In the normal mode, the primary coils receive signals from the primary guidance path of the Guidance, Navigation and Control (GN & C) Subsystem through jet driver circuitry in the attitude-translation control assembly. The abort guidance path of the GN & C Subsystem can also control the primary coils, as a backup to the primary guidance path. These control commands actuate the valves in either pulse-mode or steady-state operation. The secondary coils are connected directly to the attitude controller assembly and are energized when the Controller handle is moved to the full extent of its travel (hardover position). For a further description of the RCS operational modes, refer to the Guidance, Navigation and Control Subsystem description (paragraphs 3-34 through 3-59).

3-66. PROPULSION SUBSYSTEM.

The LEM uses separate Descent and Ascent Propulsion Subsystems, each of which is complete and independent of the other and consists of a liquid-propellant rocket engine with its propellant storage, pressurization, and feed components. The Descent Propulsion Subsystem is contained within the descent stage and uses a throttleable, gimballed engine that is first fired to inject the LEM into the descent transfer orbit and used in the final descent trajectory as a retrorocket to control the rate of descent and to enable the LEM to hover and move horizontally. The Ascent Propulsion Subsystem is contained within the ascent stage and uses a fixed, constant-thrust engine to launch the ascent stage from the lunar surface and place it in orbit. The ascent engine can also provide any gross orbit adjustments that may be necessary for rendezvous with the Command/Service modules.

The Guidance, Navigation and Control (GN & C) Subsystem provides automatic on-off commands for both engines and initiates gimbal drive actuator and thrust level commands for the descent engine. Manual override provisions for certain control functions are also available to the astronauts. Operational modes are discussed further in the Guidance, Navigation and Control Subsystem write-up (paragraphs 3-34 through 3-59); block diagrams are shown in figures 3-3 and 3-4.

Both propulsion subsystems use hypergolic propellants consisting of a 50-50 fuel mixture of hydrazine (N_2H_4) and unsymmetrical dimethylhydrazine *UDMH), with nitrogen tetroxide (N_2O_4) as the oxidizer. The mixture ratio of oxidizer to fuel is 1.6 to 1, by weight, at injection. In both stages, the propellants are supplied from slosh-suppressing tanks, with helium as the tank pressurant.

3-67. DESCENT PROPULSION SUBSYSTEM.

The Descent Propulsion Subsystem consists of two fuel and two oxidizer tanks with the associated propellant pressurization and feed components, and a throttleable rocket engine that develops a maximum thrust of 10,500 pounds and can be operated at any power setting down to a minimum thrust of 1,050 pounds. The engine can also be shut down and re-started, as required.

The engine is mounted in the center compartment of the descent stage cruciform, suspended at the throat of the combustion chamber on a gimbal ring that is an integral portion of the engine assembly. The gimbal ring is pivoted in the descent stage structure along an axis normal to that of the engine pivots so that the engine can be gimballed $\pm 6^\circ$ in any direction by means of gimbal drive actuators

LMA 790-1

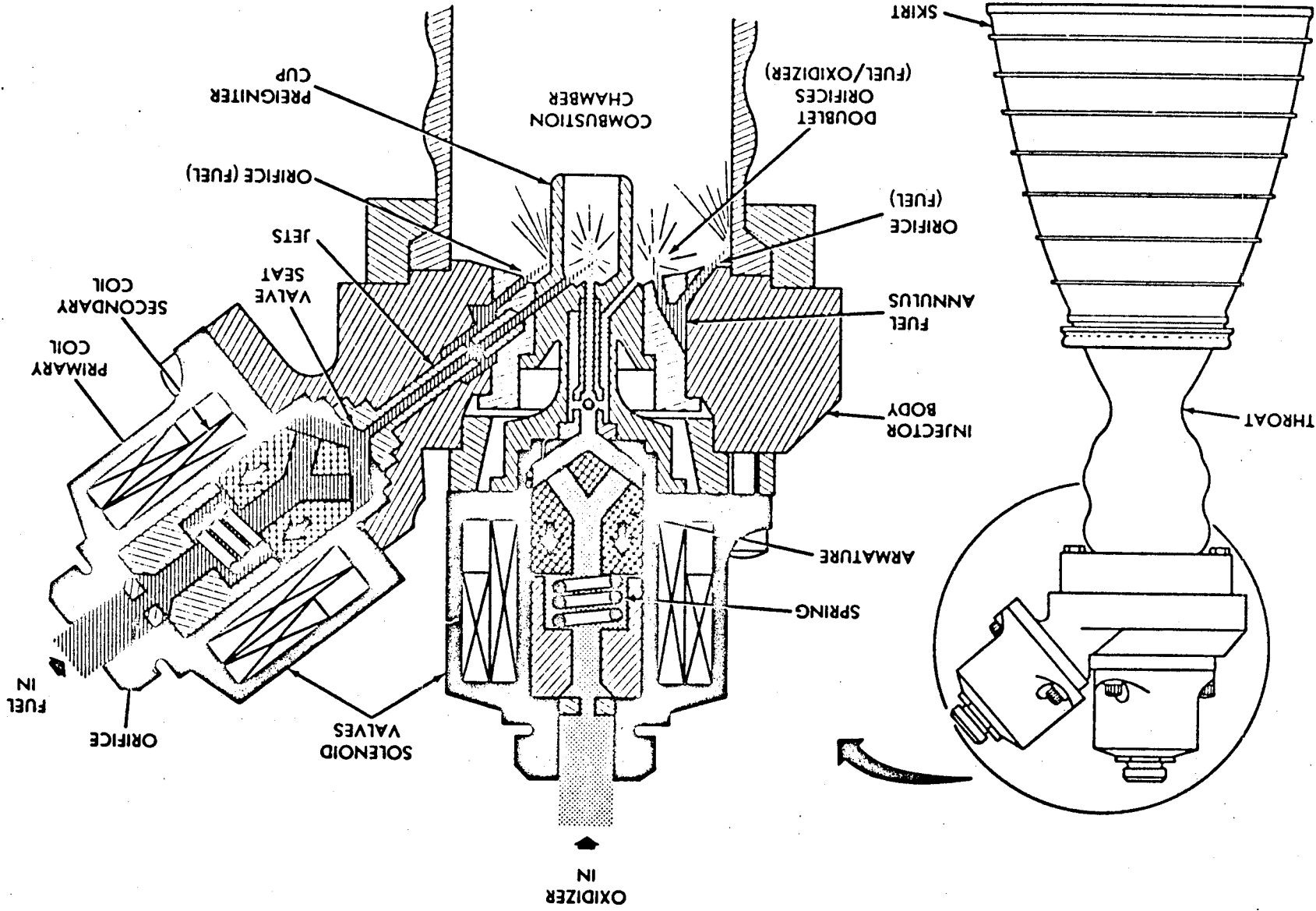

A 2011MA-35

Figure 3-13. Reaction Control Subsystem Thruster Schematic

to provide trim control in the pitch and roll axes during powered descent. The engine and tank locations in the descent stage structure are shown in figure 2-4.

3-68. Descent Propulsion Propellant Supply Sections. The descent propulsion propellant supply sections include all of the propellant storage, pressurization and feed assemblies necessary for the delivery of fuel and oxidizer to the engine valves. A schematic of the sections is shown in figure 3-14.

The descent propellant tanks are pressurized by helium that is supercritically stored as a high density gas in a cryogenic storage vessel and piped through a series of valves and pressure-reducing regulators. The helium is then introduced directly into the propellant tanks, where it acts on the surface of the fluids to force them through the system to the engine. The method of helium storage is currently the subject of a parallel development effort; there is also another study directed toward the possible use of gaseous helium stored at ambient temperatures at approximately 3,500 psi in two, interconnected pressure vessels. Supercritical storage is preferred, however; should a satisfactory supercritical system be developed, it will result in the storage of helium at a much higher density (approximately three times that of ambient storage) and will be considerably lighter in weight. Ambient storage is intended to be a backup, for use only in the event that supercritical storage does not prove to be suitable. Current subsystem design includes provisions for immediate interchangeability between the supercritical and ambient installations at any time.

The theory of supercritical storage involves the design of the storage vessel, the manner in which it is filled, and the method of maintaining working pressures during operation. The vessel is double walled, consisting of an inner spherical tank with an outer jacket; the void between the tank and its jacket is filled with aluminumized mylar insulation and evacuated to minimize ambient heat transfer from the outside. The vessel is also equipped with associated fill, vent, and pressure-relief devices and an internal heat exchanger.

During fill, the vessel is initially vented and loaded with liquid helium; the fill sequence is then completed by closing off the vent and introducing a high pressure head of gaseous helium at a warmer temperature than that of the liquid. As this occurs, the temperature transfer causes the liquid to immediately evaporate into a high density gas; once this has happened, it can no longer return to its liquid state. The pressure in the vessel then stabilizes and the temperature remains at about 15° Rankine, absolute. A normally closed squib valve isolates this supply until the valve is fired for the initial engine start (descent transfer orbit). When the squib is fired, the helium initially passes through the first loop of a two-pass fuel/helium heat exchanger, where it is permitted to absorb heat from the engine fuel, which has been circulated from the fuel tanks directly to the heat exchanger, before its ultimate delivery to the engine (see figure 3-14). The warmed helium is then routed back through the internal heat exchanger inside the storage vessel; the resultant heat transfer to the remaining gas in the vessel maintain the continuing pressure required to expel the helium throughout the entire period of operation. After passing through the internal heat exchanger, the helium is routed back through the second loop of the fuel/helium heat exchanger and post-heated for temperature conditioning prior to delivery to the regulator set.

Downstream of the fuel/helium heat exchanger, the helium flow continues through a filter and the supply line divides into two parallel legs, with a normally open solenoid valve and two pressure regulators in series in each leg. The solenoid valves are closed during the coast period of descent to prevent inadvertent tank overpressurization due to possible helium gas leakage through the regulators. The pressure regulator set steps the helium pressure down to approximately 235 psi.

The series regulators in the parallel legs are numbered 1 through 4, with regulators No. 3 and 4 (in one leg) set to deliver a slightly lower pressure than regulators No. 1 and 2 (in the parallel leg). Normally, regulators No. 3 and 4 remain locked up, and pressure is reduced through regulators No. 1 and 2. In addition, upstream regulators No. 1 and 3 are set to deliver a slightly lower pressure than each of the downstream regulators. In normal operation, regulator No. 2 remains fully open and senses a demand while control is obtained through regulator No. 1. If No. 1 fails open, control is taken over by No. 2. If regulator No. 1 or 2 fails closed, control is obtained in a similar manner through regulators No. 3 and 4.

Downstream of the regulator set, the helium flow converges into a single pressurization line and again divides into two separate supply lines (one for fuel and one for oxidizer), with a quadruple check valve set in each. A relief valve is also situated in each helium supply line to prevent any possibility of catastrophic tank overpressurization, and a burst disk upstream of each relief valve prevents possible leakage during normal operation. Downstream of the check valves, the fuel and oxidizer helium pressurization lines each divide to provide flow to each pair of tanks; the helium introduced into the tanks at approximately 225 psi, acts directly on the surface of the fluids to force them into the propellant feed lines. Each pair of tanks is manifolded into a common discharge line that contains a filter and trim orifice, from which oxidizer is piped directly to the engine and fuel is piped directly to the fuel/helium

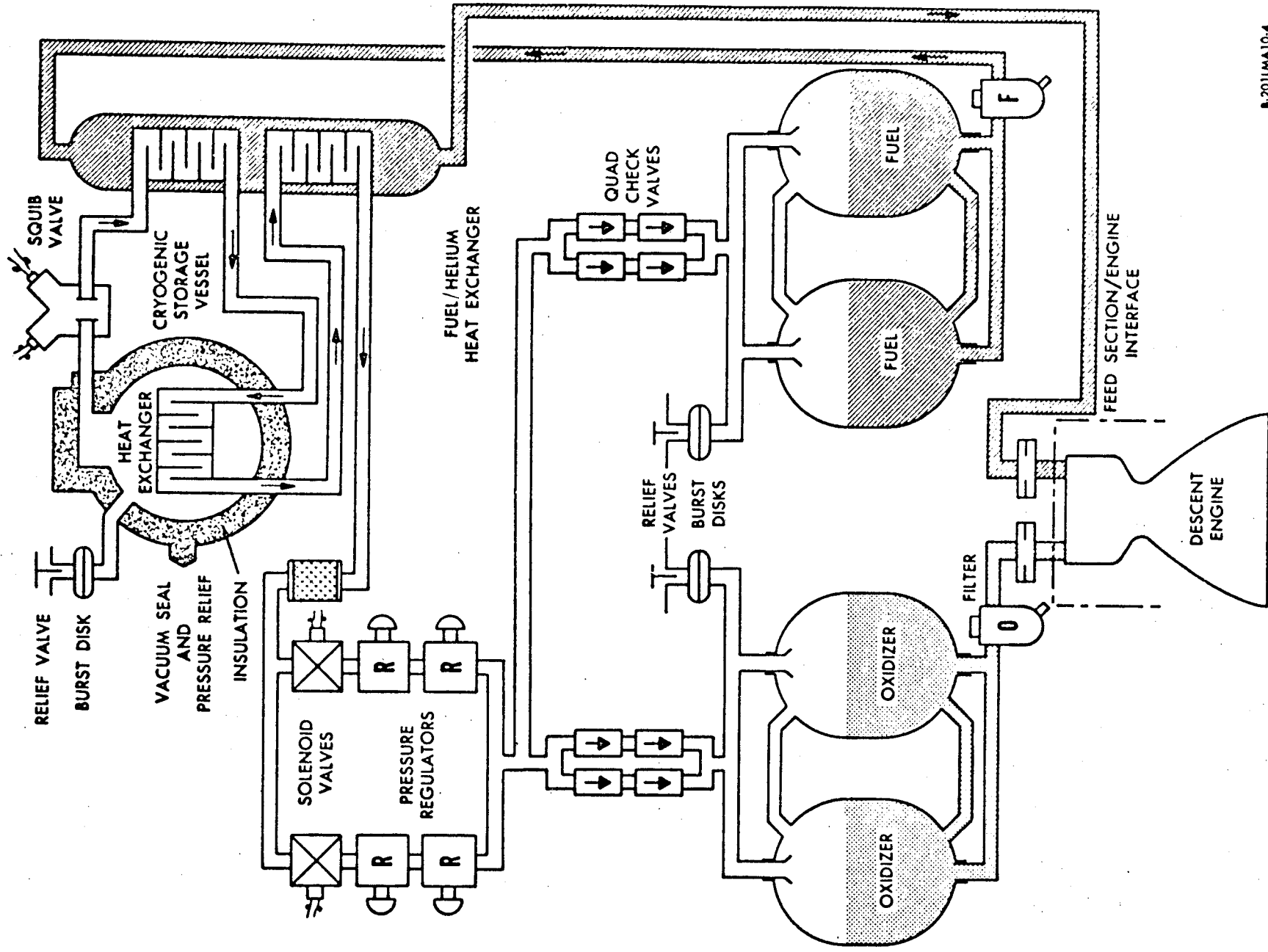

B-2011LMA10-4

Figure 3-14. Descent Propulsion Propellant Supply Sections Schematic

heat exchanger. (If ambient helium storage is used, no heat exchanger is required and the fuel, in this case, is likewise piped directly to the engine.) Both fuel and both oxidizer tanks are also interconnected by a double crossfeed piping arrangement for the purpose of maintaining positive pressure balances across the upper (helium) portions and lower (propellant) portions of each pair.

A capacitance-type quantity gaging system is used in the descent propulsion propellant tanks; this system provides a continuous digital quantity readout on the appropriate display panel in the crew compartment.

3-69. Descent Engine. The descent engine consists primarily of an ablative combustion chamber with a gimbal ring, a variable area injector, flow control and shutoff valves, and a radiation-cooled nozzle extension. The nozzle extension is designed to crush, should it contact the lunar surface upon landing. The engine has sensors to measure fuel and oxidizer inlet pressures and temperatures, injector inlet pressures, thrust chamber pressures, valve positions, vibration, and exterior surface temperatures.

Engine throttling is accomplished by routing fuel and oxidizer through separate, variable-area flow control valves that are mechanically linked to a variable-area injector to separate the propellant flow control and propellant injection functions so that each can be optimized without compromising the other. This "hydraulic decoupling" between the injector and flow control valves ensures that propellant flow rates are not affected by downstream pressure variations in the injector and combustion chamber and maintains proper propellant velocities and proper impingement angles at the injector for stable combustion, particularly at low thrust settings. Engine start and cutoff is controlled through shutoff valves located between the flow control valves and injector. A schematic of the engine injector and valves is shown in figure 3-15.

Fuel and oxidizer are initially introduced through flexible inlet lines near the gimbal ring at the engine throat and piped directly into the flow control valves. After passing through the flow control valves, the propellants pass into a series-parallel shutoff valve assembly, consisting of fuel-pressure-actuated ball valves. Fuel is introduced to the valve actuators through solenoid-operated pilot valves, all of which are energized simultaneously to accomplish the engine start. During the start, the solenoids release the caged balls from the actuator inlet ports and seat them against the overboard vent ports. Fuel enters the actuator cavities and the actuator pistons, connected to rack-and-pinion linkages, twist the ball valves 90° to the fully open position to permit flow to the injector. The series-parallel redundancy in the shutoff valve arrangement provides for positive start and cutoff; figure 3-15 shows one actuator in a closed position to illustrate this operation.

During shutdown, the solenoids are deenergized, opening the vent ports. The spring-loaded actuators close the shutoff valves and residual fuel from the actuator cavities is vented overboard into space.

The injector consists basically of a faceplate and fuel manifold assembly with a coaxial oxidizer feed tube and movable metering sleeve. Oxidizer enters through the center tube and sprays out between a fixed pintle and the bottom edge of the sleeve; fuel is introduced into an outer race and the fuel aperture is an annular opening between the sleeve side contour and the injector face. The design of the sleeve is such that both propellant apertures increase in area as the sleeve is moved upward, away from the fixed pintle. The separate fuel and oxidizer flow control valves are venturis in which the areas of the venturi throats are simultaneously regulated by close-tolerance, contoured metering pintles that are linked directly to the injector sleeve.

The mechanical linkage connecting the valve pintles and injector sleeve is pivoted about a fulcrum on the injector body; the accompanying throttle control is an electromechanical linear servoactuator with redundant d-c motors that positions the linkage in response to electrical input signals. Thrust is then regulated by movement of the actuator to simultaneously adjust the valve pintles and injector sleeve. The fuel and oxidizer are thus injected at velocities and angles compatible with variations in weight flow.

At maximum thrust, the servoactuator positions the linkage to set the flow control valves and injector apertures to the fully open position; the engine then operates as a conventional, pressure-fed rocket. As the thrust is reduced, the pintles in the flow control valves are stroked to decrease the flow control area of each venturi so that the pressure drop across the valve balances out the differential between engine inlet and injector inlet pressures and the injector apertures are adjusted so that the injection velocities and impingement angles of fuel and oxidizer are maintained at optimum conditions. At approximately 70% of maximum thrust, cavitation commences in the valve throats. From this level down to minimum thrust, the flow control valves function as cavitating venturis. Once cavitation begins, the propellant metering function is entirely removed from the injector; weight flow rate and thrust are controlled entirely by the cavitating venturis.

As temperatures vary, however, the rate of change in the vapor pressure and density of the fuel varies with that of the oxidizer. These variations in propellant properties at off-nominal temperatures thus result in relative changes in weight flow rates of fuel to oxidizer, causing a mixture ratio error. To correct this, the engine is equipped with a propellant temperature compensation (mixture ratio control) actuator that operates a vernier adjustment in the linkage that connects the fuel and oxidizer flow control valve (venturi) pintles. This actuator senses oxidizer temperature variations and automatically changes the linkage adjustment to effect a corresponding change in fuel weight flow. In doing this, the fuel pintle is pivoted about a different center, causing an increase in the fuel flow gain for subnominal temperatures or a decrease in the fuel flow gain for above-nominal temperatures. The magnitude of the fuel flow change required also depends upon the flow regime (i. e., cavitating or non-cavitating). As the engine is throttled from one flow regime to another, however, the propellant temperature compensation actuator is also automatically switched to provide the proper gain in the fuel flow.

3-70. ASCENT PROPULSION SUBSYSTEM.

The Ascent Propulsion Subsystem uses a fixed, constant-thrust rocket engine installed along the centerline of the ascent stage midsection and includes the associated propellant supply components. The engine develops 3, 500 pounds of thrust in a vacuum, sufficient to launch the ascent stage from the lunar surface and place it in orbit. Two main propellant tanks are used; one for fuel and one for oxidizer. The tanks are installed on either side of the ascent stage structure. The propellant supply sections in this subsystem include provisions for fuel and oxidizer crossfeed to the Reaction Control Subsystem as a backup propellant supply for the latter. The engine and tank locations in the ascent stage structure are shown in figure 2-3.

3-71. Ascent Propulsion Propellant Supply Sections. The ascent propulsion propellant supply sections consist of helium pressurization and propellant storage and feed sections that are functionally similar to those used in the Descent Propulsion Subsystem. A schematic of the propellant supply sections is shown in figure 3-16.

Helium is stored under pressure at ambient temperature in two separate vessels; a normally closed squib valve in the line immediately downstream of each pressure vessel isolates this supply until the valve is fired before the initial engine start. The helium flow then passes into two parallel regulator lines, each having a filter, a normally-open solenoid valve, and two pressure reducers in series. The upstream reducers on each side are set to a slightly lower pressure than those downstream; the series pair in one line is also set to deliver a slightly lower pressure than the pair in the parallel line. Normally, the upstream reducer with the lower pressure setting locks up as the tanks are pressurized; only one of the parallel lines operates at a time. If either reducer in the line fails closed, control is obtained through the reducers in the other line with the lower pressure setting. If an upstream reducer falls opens, the downstream reducer continues to regulate the supply at its own pressure setting. A fail-open condition in a downstream reducer is negligible because the upstream reducer is already in control. If both reducers in a line should fail open, the astronaut receives a tank over-pressurization indication, at which time he must close the solenoid valve in the malfunctioning line so that normal pressure reduction can be obtained through the parallel line.

Downstream of the pressure reducer lines, the helium flow lines are manifolded together and then divide into two separate propellant tank pressurization lines, with a quadruple check valve set in each (the check valves isolate the fuel and oxidizer tanks so that the vapors from one tank cannot back up through the helium manifolds into the other tank before pressurization.) A burst disk and relief valve are located in the helium pressurization line adjacent to each tank to prevent any possibility of catastrophic tank overpressurization. The burst disk is set to rupture at a slightly lower pressure than that required to crack the relief valve to prevent possible helium loss during normal pressurization. The helium is then piped into the baffled propellant tanks, where it acts directly on the surface of the fluids to force them through the system to the engine. Low-level sensors are used to monitor fuel and oxidizer quantities in the ascent propellant tanks.

3-72. Ascent Engine. The ascent engine is a conventional, restartable, bipropellant rocket engine with an all-ablative combustion chamber, throat, and nozzle extension. Instrumentation includes sensors for measuring fuel and oxidizer inlet pressures, injector inlet pressures, thrust chamber pressure, valve positions, vibration, and exterior surface temperatures. Propellant flow to the engine combustion chamber is controlled through the valve package, trim orifices, and injector assembly, as shown in figure 3-17. At the feed section/engine interface, the fuel and oxidizer lines are connected to the valve package assembly, which consists of similar propellant and isolation valves, mounted back-to-back, with oxidizer flow on one side and fuel flow on the other side. Inside the valve body, both the fuel and oxidizer passages divide into dual flow paths, with a series-parallel ball valve arrangement in each; the paths rejoin at the outlet. The ball valves are arranged in fuel-oxidizer pairs; each pair is operated on a single-crankshaft assembly by an individual fuel-pressure-operated actuator. Shaft seals and vented cavities prevent the possibility of fuel and oxidizer from coming into contact with each

Figure 3-15. Descent Engine Injector and Valves

A 2014MA10.26

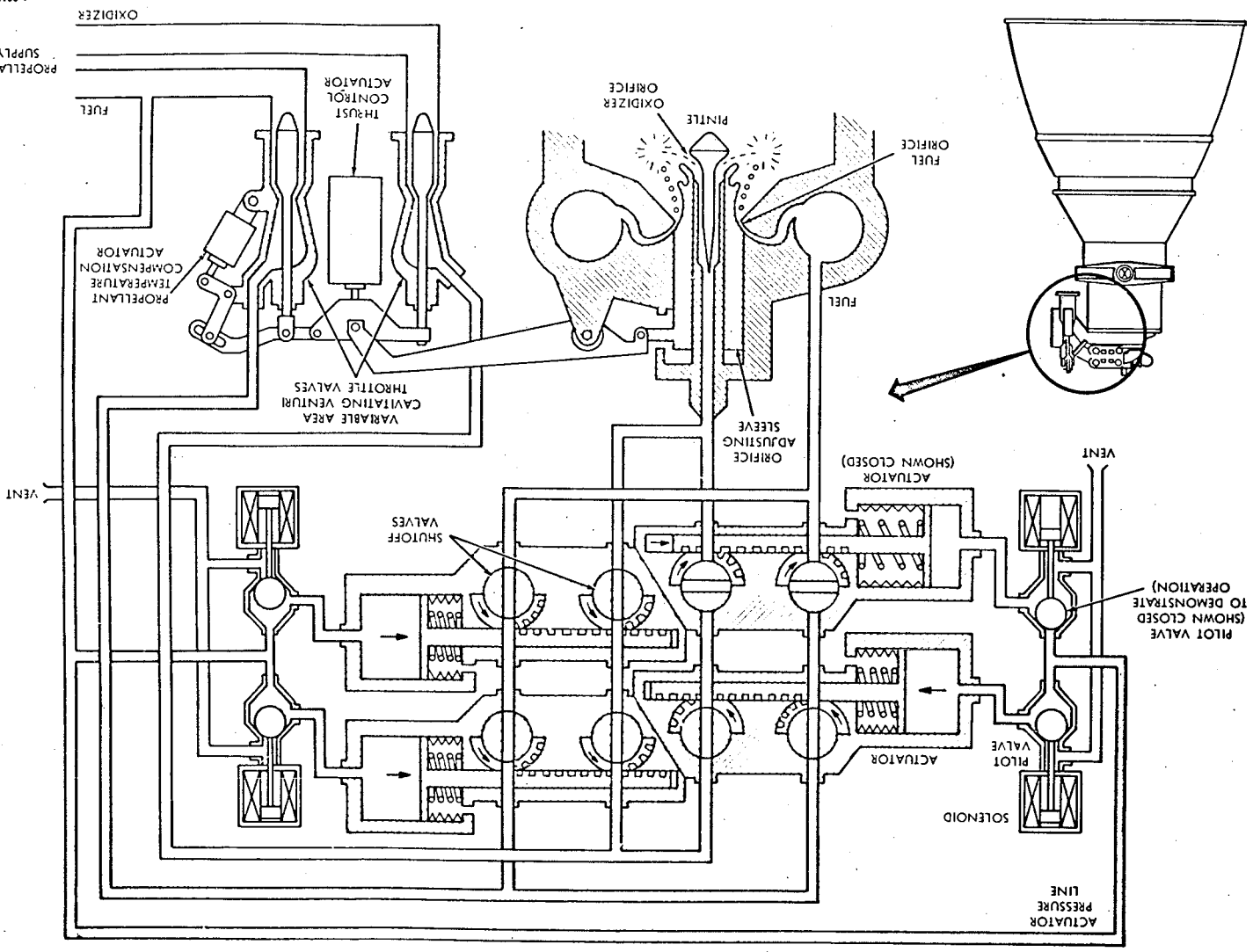

LMA790-1

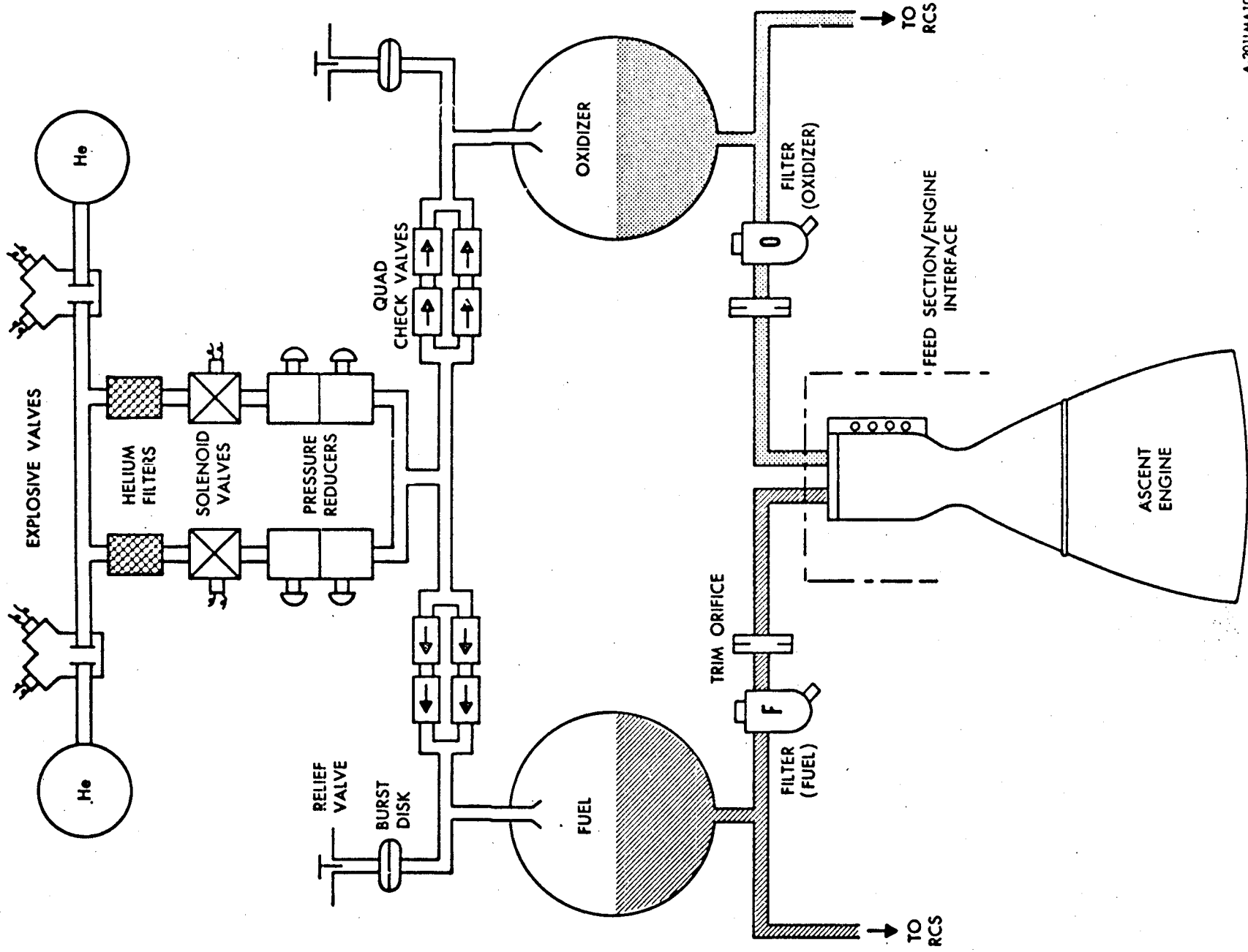

A-201LMA10-5

Figure 3-16. Ascent Propulsion Propellant Supply Section Schematic

15 October 1965

3-49

other through seepage along the shafts. The complete assembly thus contains eight ball valves on four crankshaft assemblies, four actuators, and a solenoid-operated, three-way valve for each actuator. Four manifold assemblies are also mounted on the valve package; these are: oxidizer shaft seal vent, fuel shaft seal and actuator vent, actuator fuel pressure, and solenoid valve vent.

Engine start is accomplished by energizing the solenoid valves; the valve poppets are lifted from the fuel pressure ports and seated against the overboard vent ports. Fuel then passes to the actuator chambers and the actuator pistons are extended, cranking the ball valves 90° to the full open position. Fuel and oxidizer then pass through trim orifices and are piped directly to the injector.

At cutoff, the solenoids are deenergized, opening the actuator ports to the overboard vent. Residual fuel in the actuators is vented overboard into space and the actuator pistons are released to close under spring pressure and pull the ball valves back to the closed position.

The injector is of fixed-area, fixed-orifice design, with the orifices arranged in a circular pattern on the injector face in the combustion chambers. The main orifices provide triplet spray patterns consisting of two fuel streams impinging upon one oxidizer stream. Near the outer periphery of the injector face, the propellant orifices are drilled in doublets (one fuel stream impinging upon one oxidizer stream) to provide a low temperature exhaust gas barrier near the ablative chamber wall.

The injector cutaway shown in figure 3-17 reflects the basic design concept, only. Current experiments are directed toward a design change that involves the addition of three baffles, radially spaced 120° apart on the face of the injector. The baffles are intended to contribute to the overall combustion stability; the development effort concerns itself with arriving at an optimum means of cooling these baffles. Information concerning the finalized design configuration will be provided when it becomes available.

3-73. INSTRUMENTATION SUBSYSTEM. (See figure 3-18.)

The Instrumentation Subsystem senses physical data, monitors the LEM subsystems during manned phases of the mission, performs an inflight and lunar surface checkout, prepares LEM status data for transmission to earth, provides timing frequencies for the LEM subsystems, and stores voice data when the LEM is unable to transmit to earth. The Instrumentation Subsystem consists of sensors, the signal conditioning electronics assembly (SCEA), caution and warning electronics assembly (CWEA), pulse code modulation and timing electronics assembly (PCMTEA), and the data storage electronics assembly (DSEA). The subsystem equipment operates on 28 volts dc and 115-volt, 400-cps, single-phase power supplied by the Electrical Power Subsystem. The Instrumentation Subsystem provides the astronauts and ground facilities with LEM performance data during all phases of the mission. This enhances astronaut safety and mission success. Included within the Instrumentation Subsystem are scientific instruments which will be used by the astronauts during lunar stay.

3-74. SENSORS AND SIGNAL-CONDITIONING ELECTRONICS ASSEMBLY.

The sensors in the LEM subsystems sense data such as temperature, valve action, pressure, switch position, voltage, and current and convert the data into signals which are applied to the SCEA. The SCEA includes signal modifiers, d-c amplifiers, d-c attenuators, and ac-to-dc converters that condition the signals into a form compatible with the output equipment. In addition to the signals from the sensors, the SCEA receives signals directly from other components within the LEM. Not all signals presented to the SCEA require conditioning. The outputs of the SCEA are fed to the CWEA or PCMTEA, or both.

3-75. CAUTION AND WARNING ELECTRONICS ASSEMBLY.

The CWEA provides the astronauts and ground stations with a rapid check of LEM status during the manned phase of the mission. The input data from the SCEA is continuously monitored by the CWEA to detect a malfunction. If a malfunction is detected, the CWEA provides signals to the Control and Displays to activate tone generators, to illuminate caution or warning lights, and illuminate two master alarm switch lights. The astronauts are thereby alerted to the malfunction and aided in isolating it. The warning lights indicate a malfunction that jeopardizes the astronaut and requires immediate action. The caution lights indicate a malfunction that does not require immediate action. Signals that reflect malfunctions are applied to the PCMTEA for telemetering to earth.

3-76. PULSE CODE MODULATION AND TIMING ELECTRONICS ASSEMBLY.

The PCM changes all LEM data into digital signals for transmission to earth. The PCMTEA consists of analog multiplexers, amplifiers, an analog-to-digital converter (coder), a digital multiplexer, an output register, a programmer, and a timing generator. It combines analog inputs, parallel digital

Figure 3-17. Ascent Engine Injector and Valves

D-201MA10-27

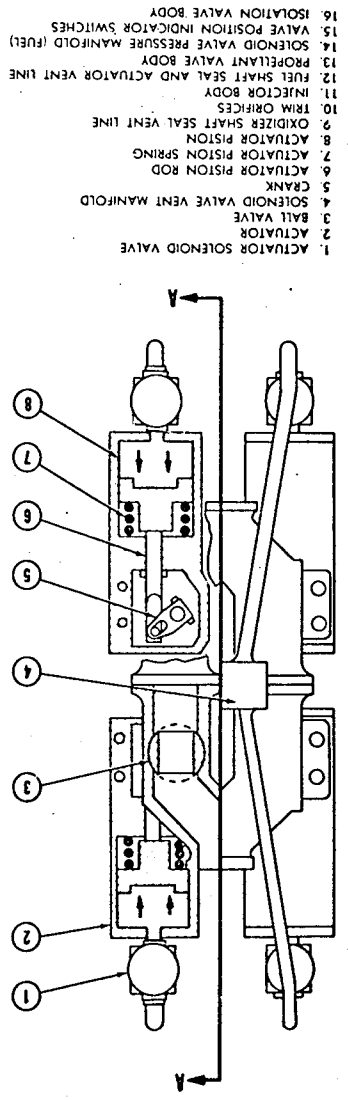
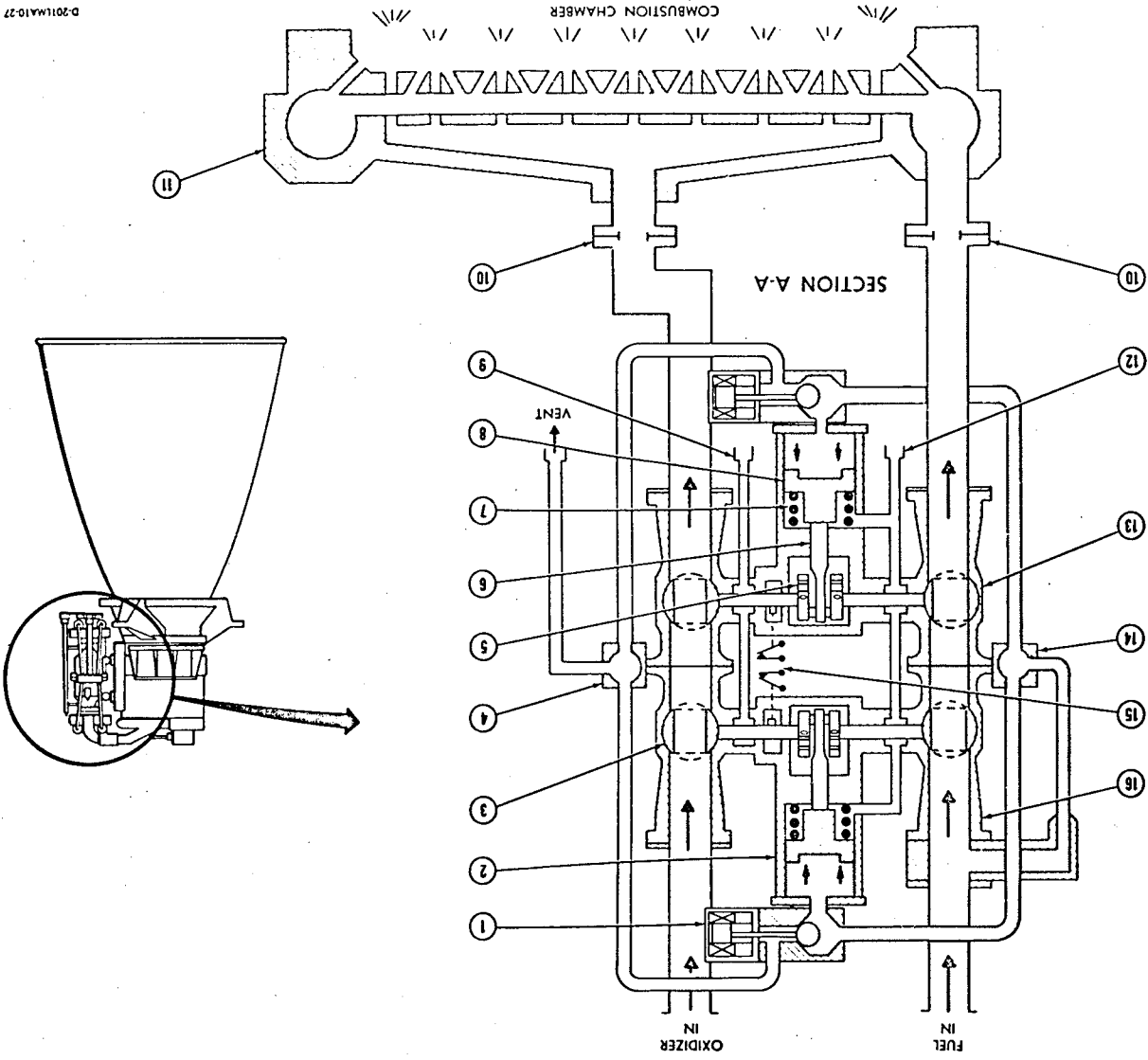

1. ACTUATOR SOLENOID VALVE
2. ACTUATOR
3. BALL VALVE
4. SOLENOID VALVE VENT MANIFOLD
5. CRANK
6. ACTUATOR PISTON ROD
7. ACTUATOR PISTON SPRING
8. ACTUATOR PISTON
9. OXIDIZER SHAFT SEAL VENT LINE
10. TRIM ORIFICES
11. INJECTOR BODY
12. FUEL SHAFT SEAL AND ACTUATOR VENT LINE
13. PROPELLANT VALVE BODY
14. SOLENOID VALVE PRESSURE MANIFOLD (FUEL)
15. VALVE POSITION INDICATOR SWITCHES
16. ISOLATION VALVE BODY

Figure 3-18. Instrumentation Subsystem Block Diagram

13 October 1965

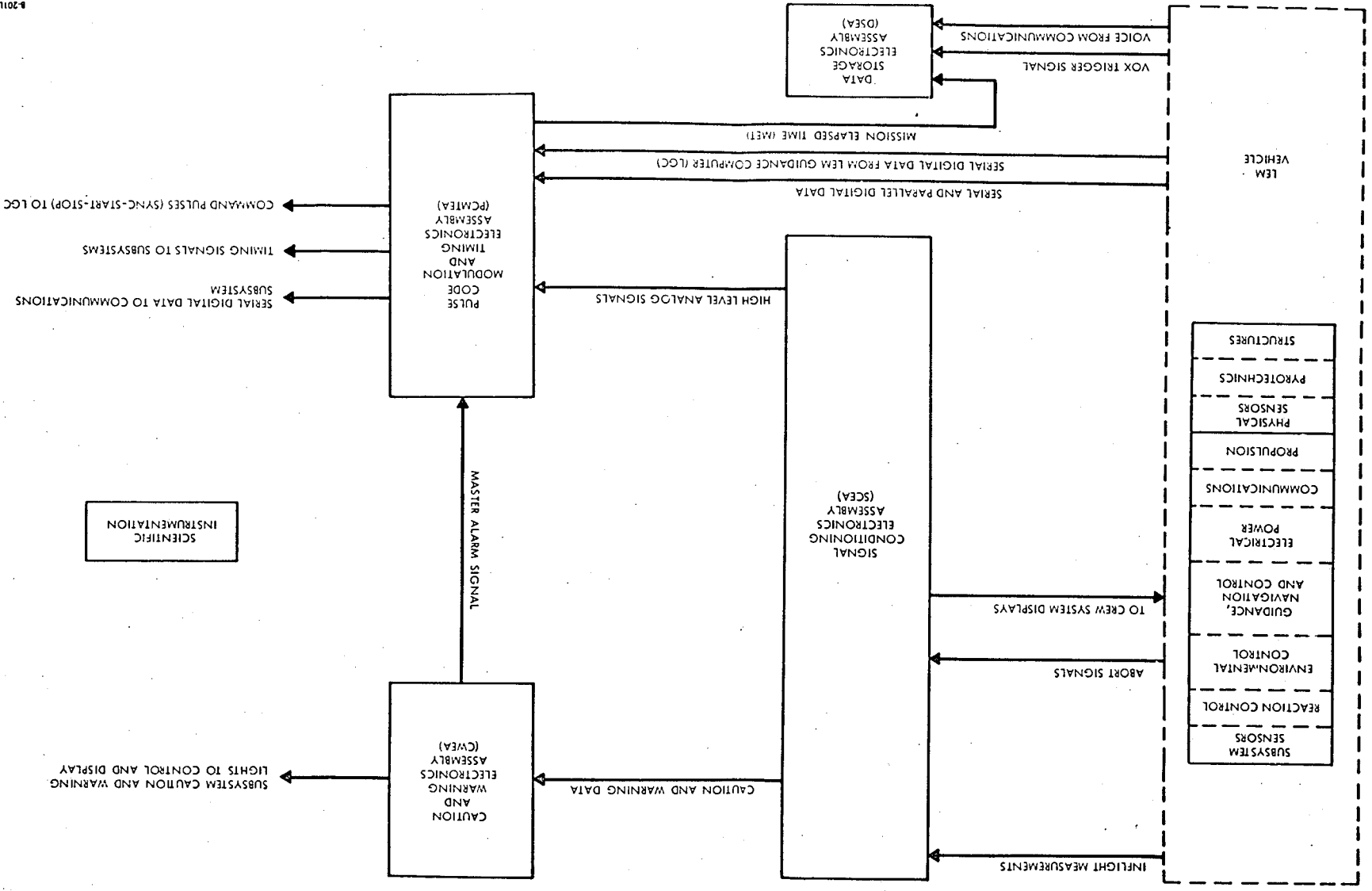

inputs, and serial digital inputs into a serial digital data train for transmission to earth at one of two selectable rates: 1,600 bits per second or 51,200 bits per second. The timing generator provides timing reference frequencies for guidance, telemetry, DSEA, and displays. In addition, during pre-launch checkout the PCMTEA data is monitored by the Acceptance Checkout Equipment - Spacecraft (ACE-S/C).

3-77. DATA STORAGE ELECTRONICS ASSEMBLY.

The DSEA provides tape storage for voice and time-correlated data; it is used by the astronauts as an automatic "notepad". The DSEA has no playback capabilities and the tape will be carried back to the Command/Service module by the astronauts for return to earth.

3-78. SCIENTIFIC INSTRUMENTS.

The LEM has scientific instruments for use by the astronauts in sampling, observing and recording selenographic data during the lunar stay. The scientific instrument payload includes a self-contained telemetering system to be set up on the lunar surface to provide postmission data-transmission to earth. Scientific activities on the lunar surface are categorized as active or passive: active experiments are performed during lunar stay and require astronaut participation; passive experiments do not. Passive experiments are initially set up by the astronauts and continue to send data to earth after lunar launch. Typical scientific equipment used in each of these categories is listed in table 3-3.

Sample-return will be an important lunar activity. Two sample-return containers are stored in the LEM and transferred to the Command Module for earth return. These containers, which the astronauts are required to vacuum-seal on the lunar surface, are paralleloipeded pressure vessels that are designed to minimize contamination of the enclosed lunar samples. The containers will be opened in a moon-simulated environment at the NASA sample-return facility at Houston. The extravehicular astronaut (EVA) will perform scientific operations such as map reading, photography, field geology, core drilling, seismic experiments, and soil mechanics experiments.

Long-term measurements will be accomplished by the passive equipment packages that make up the self-contained telemetering system. Data from the proton flux counter, solar wind instrument, meteoroid ejecta instrument, magnetometer, thermocouple, and other instrumentation are fed to the telemetry equipment for transmission to earth; the power supply (radioisotope thermoelectric generator) provides sufficient energy to operate the system for at least a year subsequent to abandonment on the lunar surface.

3-79. COMMUNICATIONS SUBSYSTEM. (See figure 3-19.)

The Communications Subsystem is the link between the LEM, the Manned Space Flight Network (MSFN), the CSM, and the EVA. Various stations of this communications link are required to carry voice, pcm telemetry (instrumentation data), biomedical data, deep space in-flight tracking and ranging, television, and emergency-keyed CW.

A combination of signal processing, television, vhf, and S-band equipment is used in these communication links. Cables are used between the television camera and the LEM and between the astronauts and the LEM when the astronauts are in the LEM. VHF communication is used between the LEM and the CSM and between the LEM and the EVA. S-band communication is used between the LEM and MSFN.

Transducers in the subsystems of the LEM send signals representing the status of the LEM and particular operational equipment to the Instrumentation Subsystem. The Instrumentation Subsystem converts these signals to a usable form and routes them to the Communications Subsystem for transmission to earth.

The cable between the LEM and astronauts carries audio to the astronauts and audio and biomedical information to the LEM. This same information is transmitted from the EVA to the LEM, along with extravehicular mobility unit (EMU) data, via a vhf duplex operation link, while audio is transmitted to the EVA. The television section is used to transmit images within the LEM and within an 80-foot radius of the LEM during lunar stay.

A vhf duplex link for audio is available for use between the LEM astronaut and the EVA. A simplex link is used for audio between the LEM and the CSM. In addition, a one-way vhf data link carries low-bit-rate telemetry data from the LEM to the CSM to record telemetry data from the LEM during those portions of the LEM lunar orbit during which the LEM orbit is at the far side of the moon and the LOS with earth is not available. This data is subsequently broadcast to earth by the CSM.

Table 3-3. Scientific Instruments

Active	Weight (Pounds)	Passive	Weight (Pounds)
*Sample containers	10.0	Power supply (radioisotope thermoelectric generator)	50.0
*Hand-held still camera	6.6	Telemetry	31.0
*Film packs (2)	0.8	Multiaxis seismometer	34.0
*Accessories (lens, filters)	0.5	Moon tide meter	4.0
Tripod	2.0	Proton Flux Counter	4.0
Geology hand tools	17.6	Solar wind instrument	3.0
Photomosaics	0.2	Meteoroid ejecta instrument	12.0
Core drill	30.0	Magnetometer	9.2
Phototheodolite attach	3.0	Anchor bolts	2.0
Heliograph	2.0	Thermal probe and packing	2.0
Thumper plate (seismic)	4.0	Total	151.2
Soil mechanics equipment	6.0		
Geophones (5)	2.5		
Seismic recorder	10.0		
†2,000 cable	4.0		
Crackers	0.1		
Total	99.8		

Equipment Not Charged to Scientific Payload

Motion picture or sequence camera and film

TV camera and accessories

Medical or bio-med packages

*Carried in LEM ascent stage.

The S-band link carries audio from earth to the LEM, and audio, biomedical pulse code modulation (PCM) telemetry and television transmission from the LEM to earth. In addition, the S-band acts as a transponder that receives receiving pseudorandom noise signals from earth for retransmission in phase-coherence to earth for tracking and ranging purposes.

Several combinations of these communication links may be used. Provisions are made for LEM-earth-CSM and LEM-earth-EVA conferences, the LEM being used as a relay between the EVA and earth. The MSFN stations can be used to relay communications between the LEM and the CSM; in an emergency, the LEM can relay CSM transmissions to earth. Simultaneous operation is possible of different links, such as pcm telemetry to earth via S-band and two-way LEM-EVA via vhf.

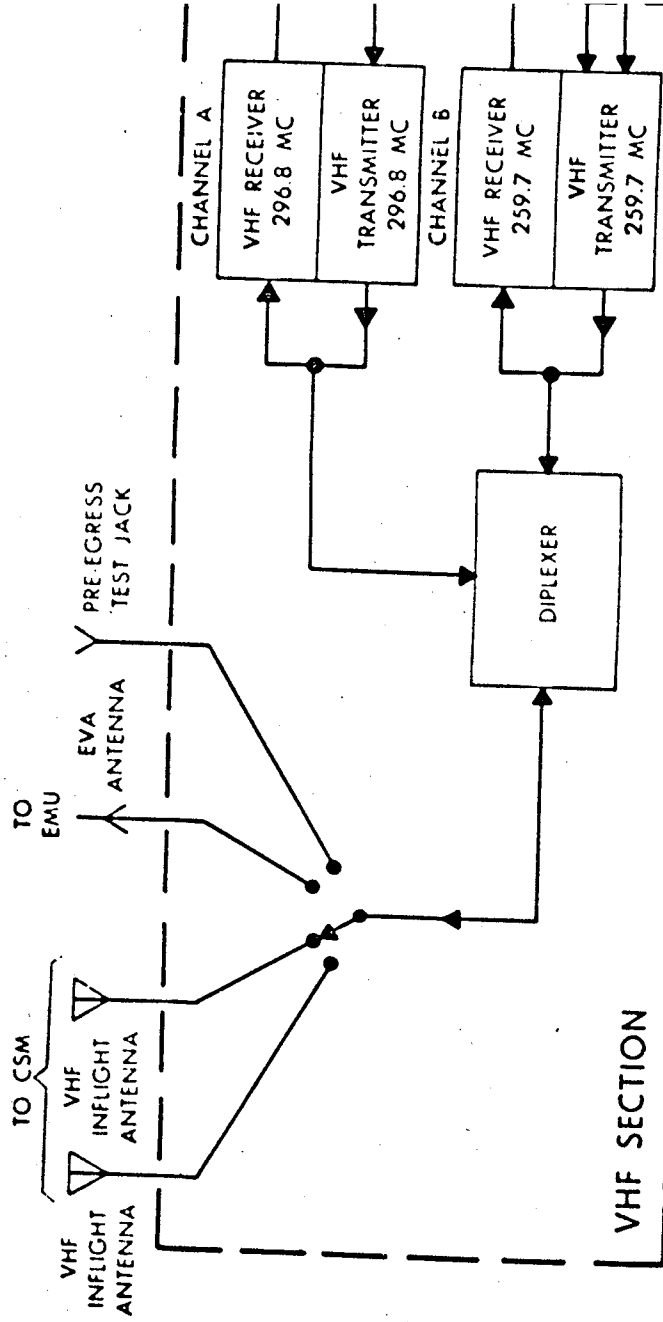

PART OF SPACE SUIT ASSEMBLY 1 OF 2

SUIT DATA

BIOMEDICAL SENSORS AND SIGNAL CONDITIONERS

BACKPACK ANTENNA

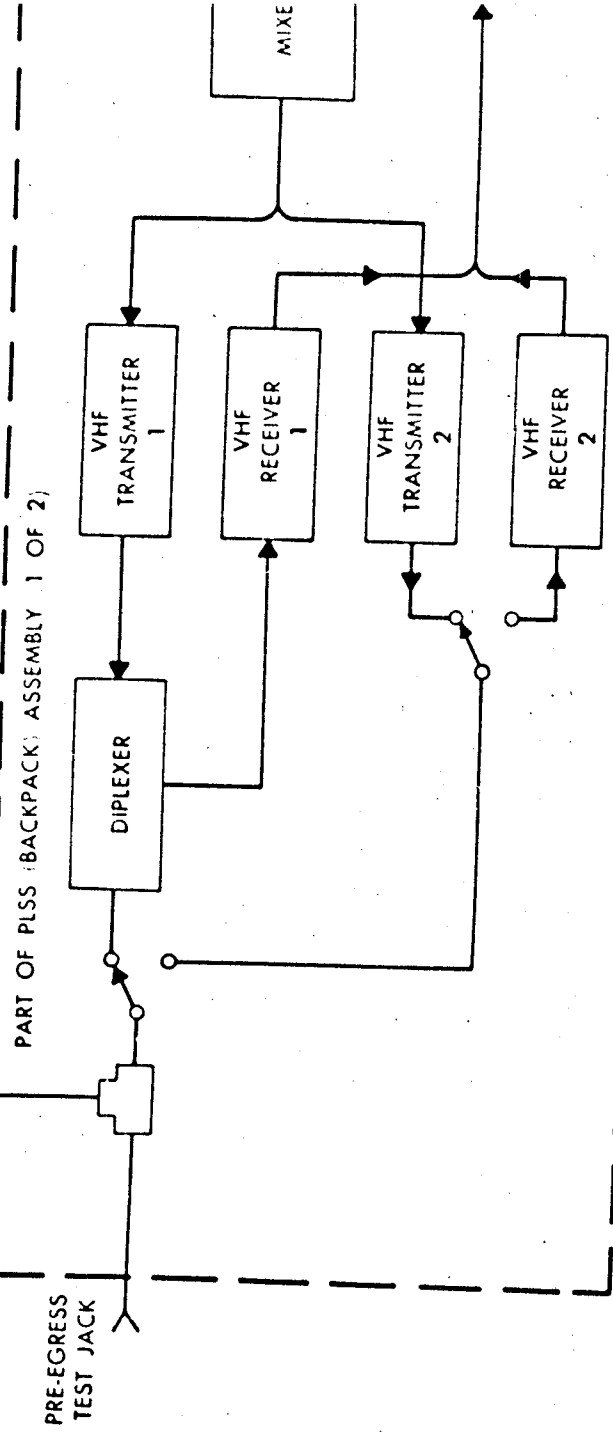

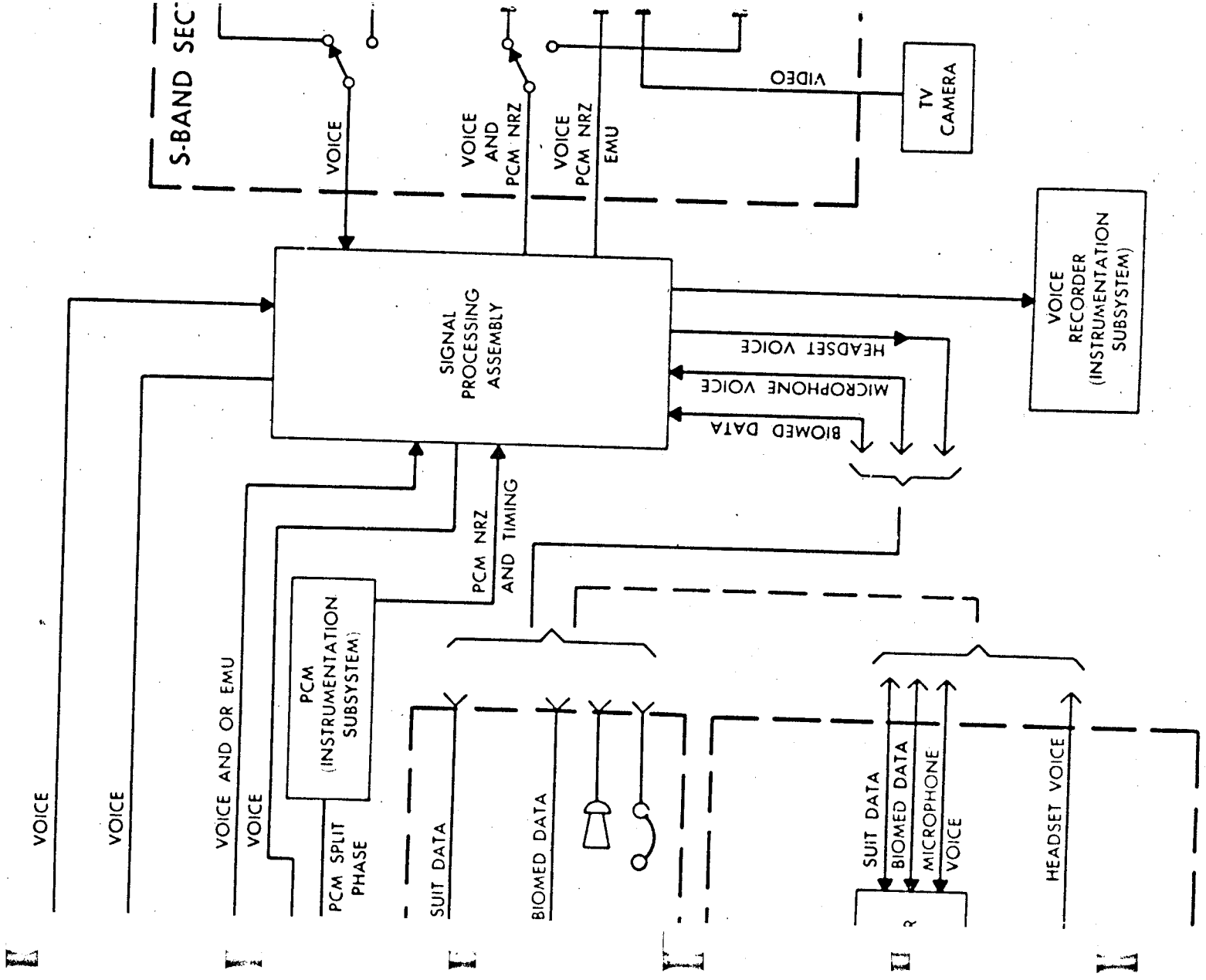

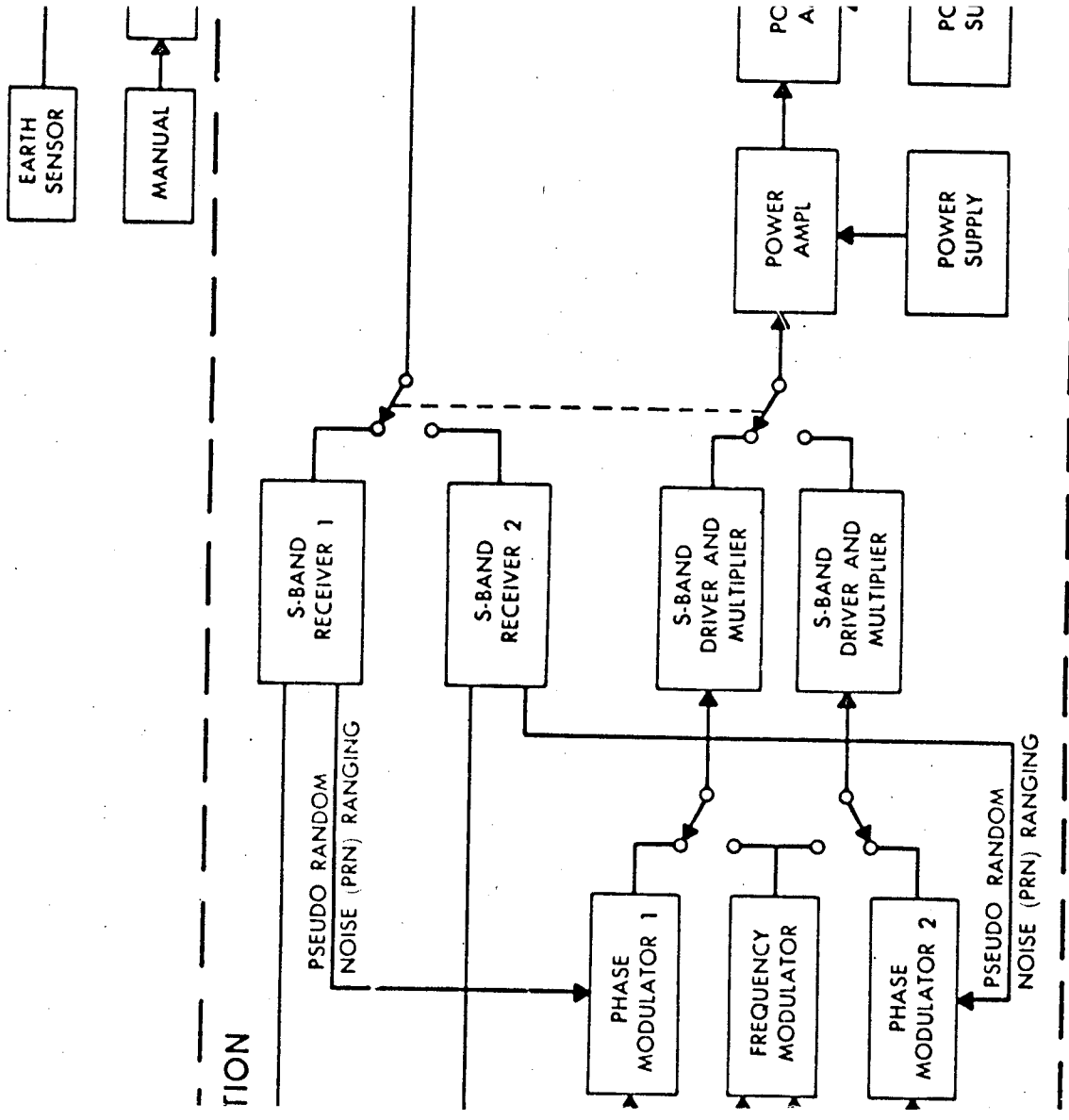

NOTE: EMU-EXTRAVEHICULAR MOBILITY UNIT TRANSMITS BOTH EVA VOICE AND DATA

Figure 3-19. C

15 October 1965



LMA790-1

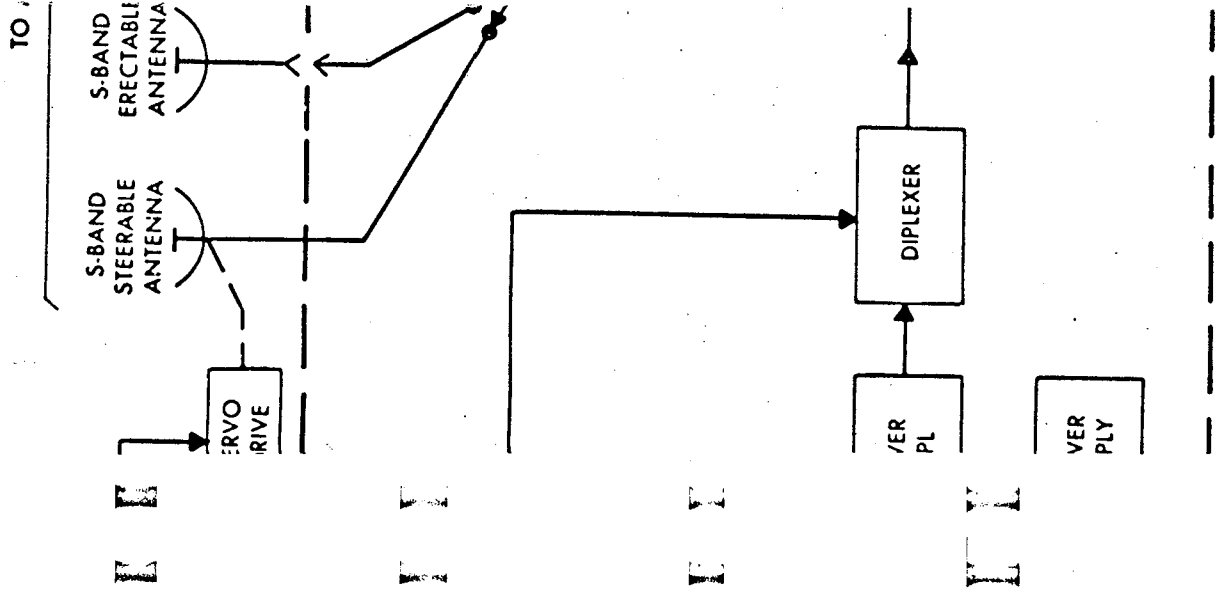

Communications Subsystem Block Diagram

MSFN

S-BAND
INFLIGHT
ANTENNA
(OMNI)

S-BAND
INFLIGHT
ANTENNA
(OMNI)

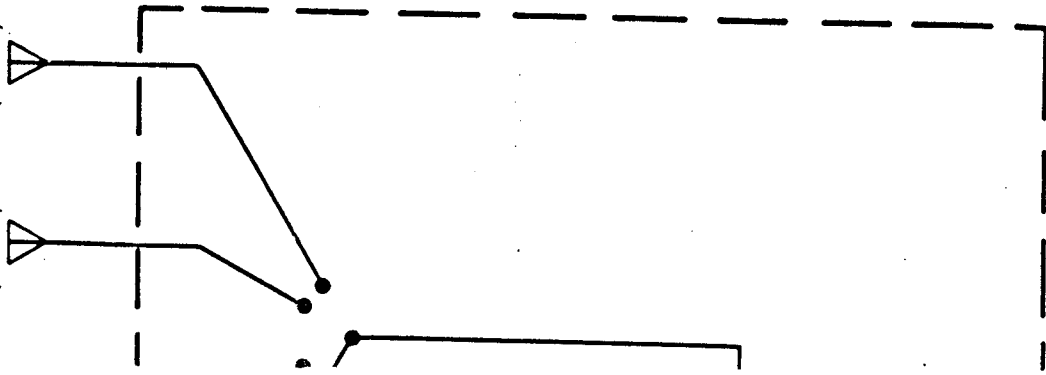

8-201LMA1038

am

3-57/3-58

3-80. IN-FLIGHT OPERATIONS. (See figures 3-20 and 3-21.)

The in-flight LEM communications schedule requires operation of the S-band equipment to transmit astronaut voice, biomedical data from either LEM astronaut, and subsystem telemetry (TM) to MSFN; to retransmit pseudorandom noise (prn) ranging signals to MSFN; and to receive voice and PRN ranging signals from MSFN.

The outgoing signals are combined before phase-modulating the 2282.5-mc carrier transmitted to MSFN. A diplexer network permits use of a single antenna for 2282.5-mc transmission and simultaneous reception of the 2101.8-mc carrier from MSFN.

The in-flight schedule also requires operation of the vhf equipment to transmit astronaut voice to the CSM, to receive voice from the astronaut in the CSM, and to transmit PCM to the CSM during those portions of the LEM lunar orbit in which line of sight (LOS) with earth is lost.

During the portion of the LEM lunar orbit in which the LEM has LOS with earth and with the CSM, and both astronauts are in the LEM, S-band transmission takes place as already described. In addition, the vhf equipment is used to communicate with the CSM using duplex operation. Transmission is on channel A (296.8 mc); reception is on channel B (259.7 mc).

During the portion of the LEM lunar orbit in which the LEM and CSM do not have LOS with earth but have LOS with each other, all S-band equipment is turned off. VHF audio communication between the LEM and the CSM is accomplished on channel A (simplex operation); low-bit-rate PCM is transmitted from the LEM to the CSM on channel B. This data is recorded in the CSM for retransmission to earth when LOS is achieved.

The communications links and their functions are listed in table 3-4.

Table 3-4. Communications Links

Link	Mode	Band	Purpose
Earth-LEM-earth	Pseudorandom noise	S-band	Ranging and tracking
LEM-earth	Voice	S-band	In-flight and lunar stay
LEM-EVA	Voice-EMU data	VHF duplex	Lunar stay
LEM-CSM	Voice	VHF simplex	In-flight and lunar stay
LEM-CSM-earth	Voice	S-band - VHF	Conference
LEM-earth	Video	S-band fm	Television
LEM-CSM	LO BT telemetry	VHF (one way)	Record and retransmit to earth
Earth-LEM	Voice	S-band	In-flight and lunar stay
LEM-earth	Biomed pcm telemetry	S-band	In-flight and lunar stay
LEM-earth-CSM	Voice	S-band	Conference (with earth as relay)

3-81. LUNAR-STAY OPERATION. (See figure 3-22.)

The LEM-CSM-MSFN communications link is expanded during lunar stay to include the EVA and transmission of televised lunar-surface images. S-band and vhf lunar-stay operations differ somewhat from the in-flight schedule. In addition to S-band direct communications with MSFN, the lunar-stay LEM communications schedule requires operation of the LEM vhf equipment to transmit voice from the astronaut in the LEM or to relay voice from the EVA to the astronaut in the CSM, to receive voice and biomedical and EMU data from the EVA, and to receive voice from the astronaut in the CSM. The primary mode of communication between the LEM and the CSM at this time is via earth, using S-band equipment. VHF transmitter-receiver A is used for LEM-CSM simplex voice communication during the time that the CSM has LOS with the LEM.

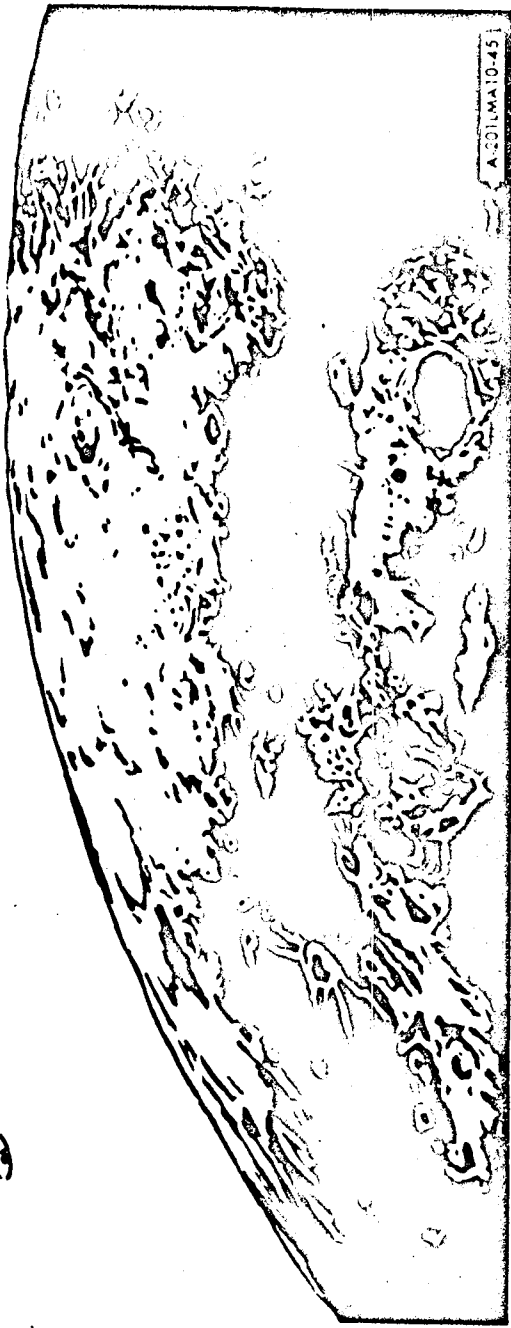
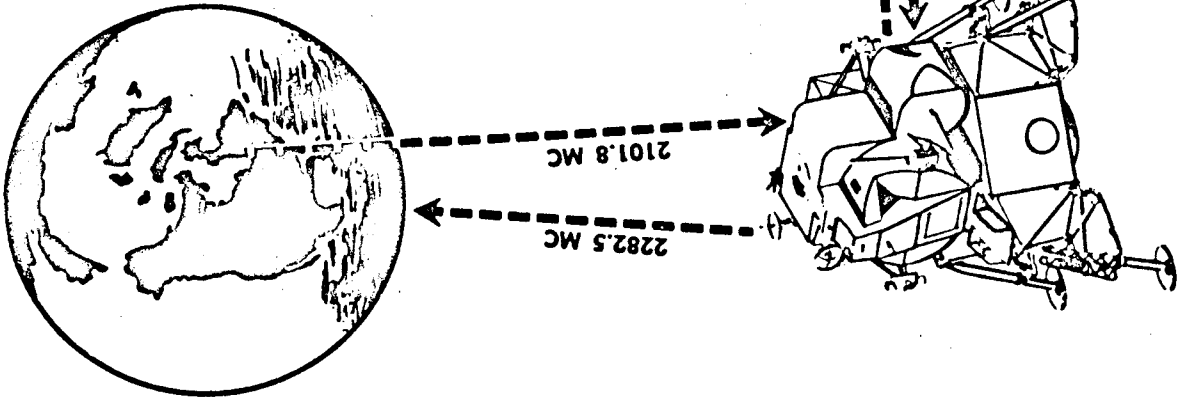
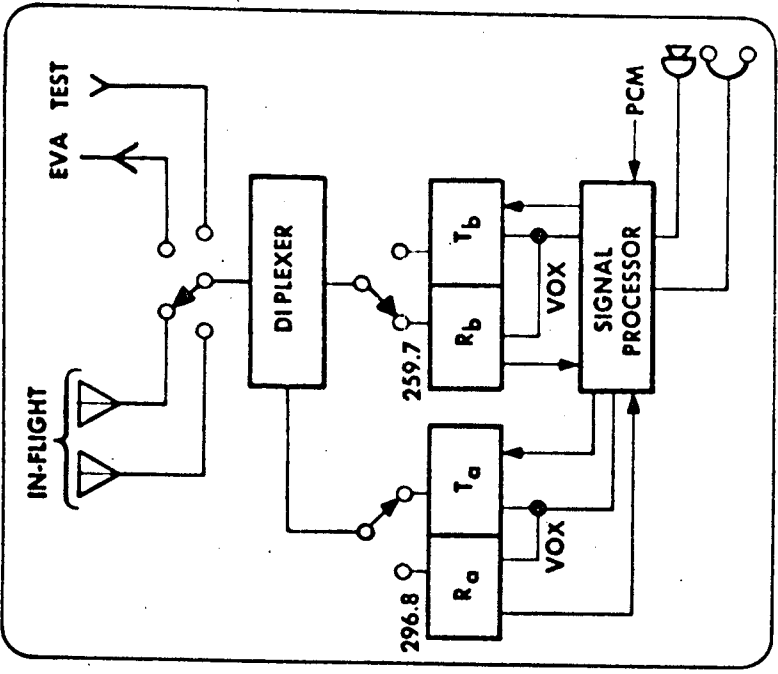

Figure 3-20. In-Flight Communications (Earth Side)

LMA790-1

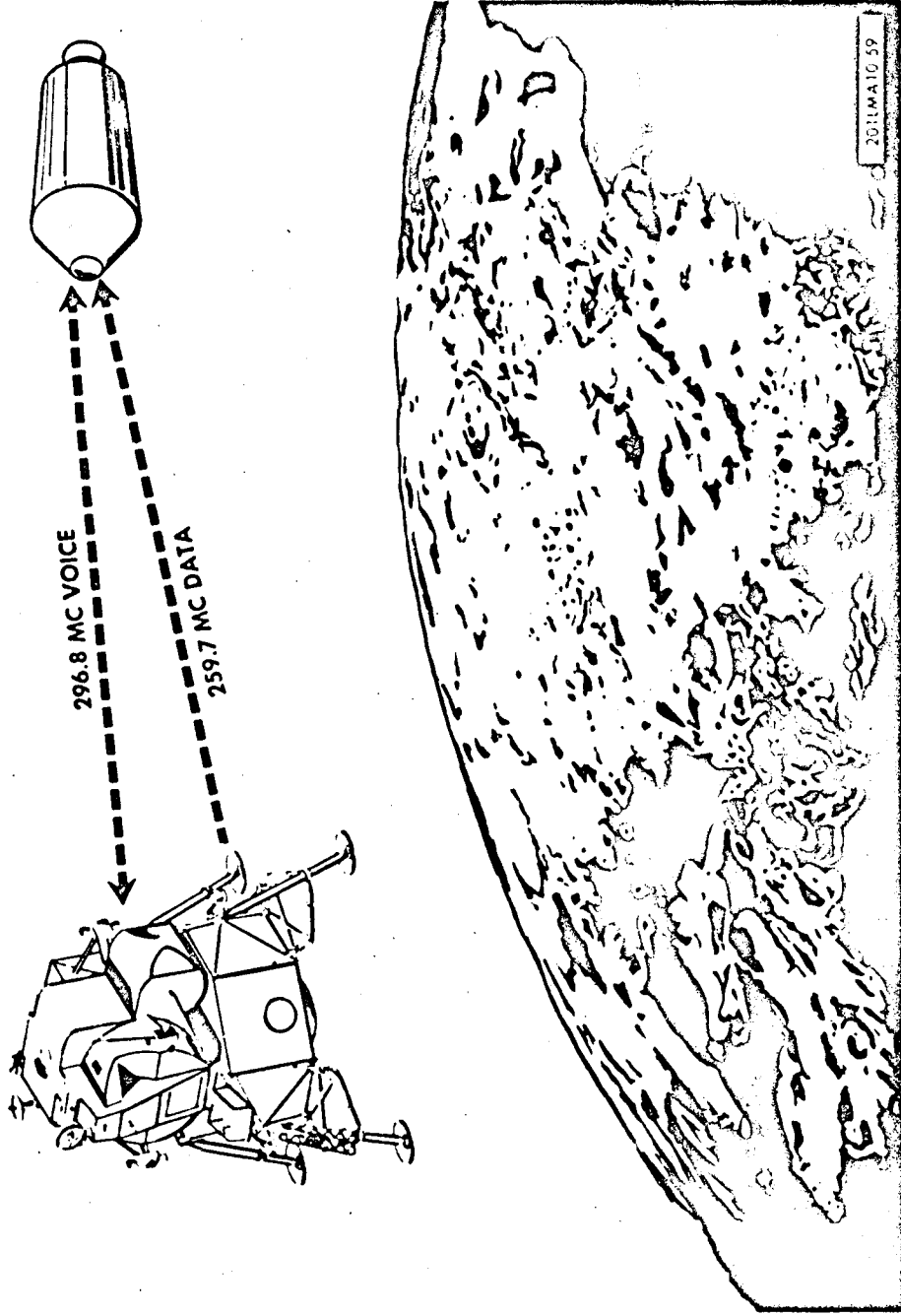
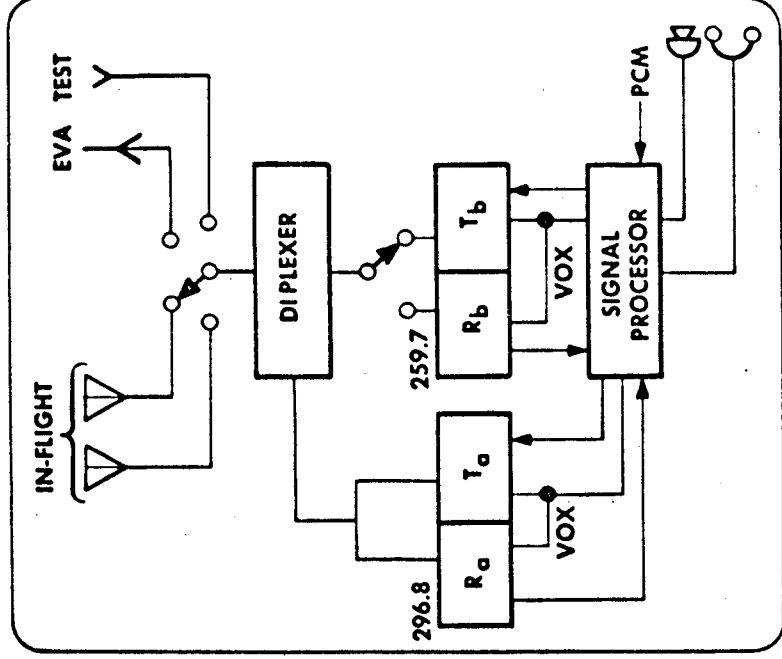

Figure 3-21. In-Flight Communications (Far Side)

15 October 1965

3-61

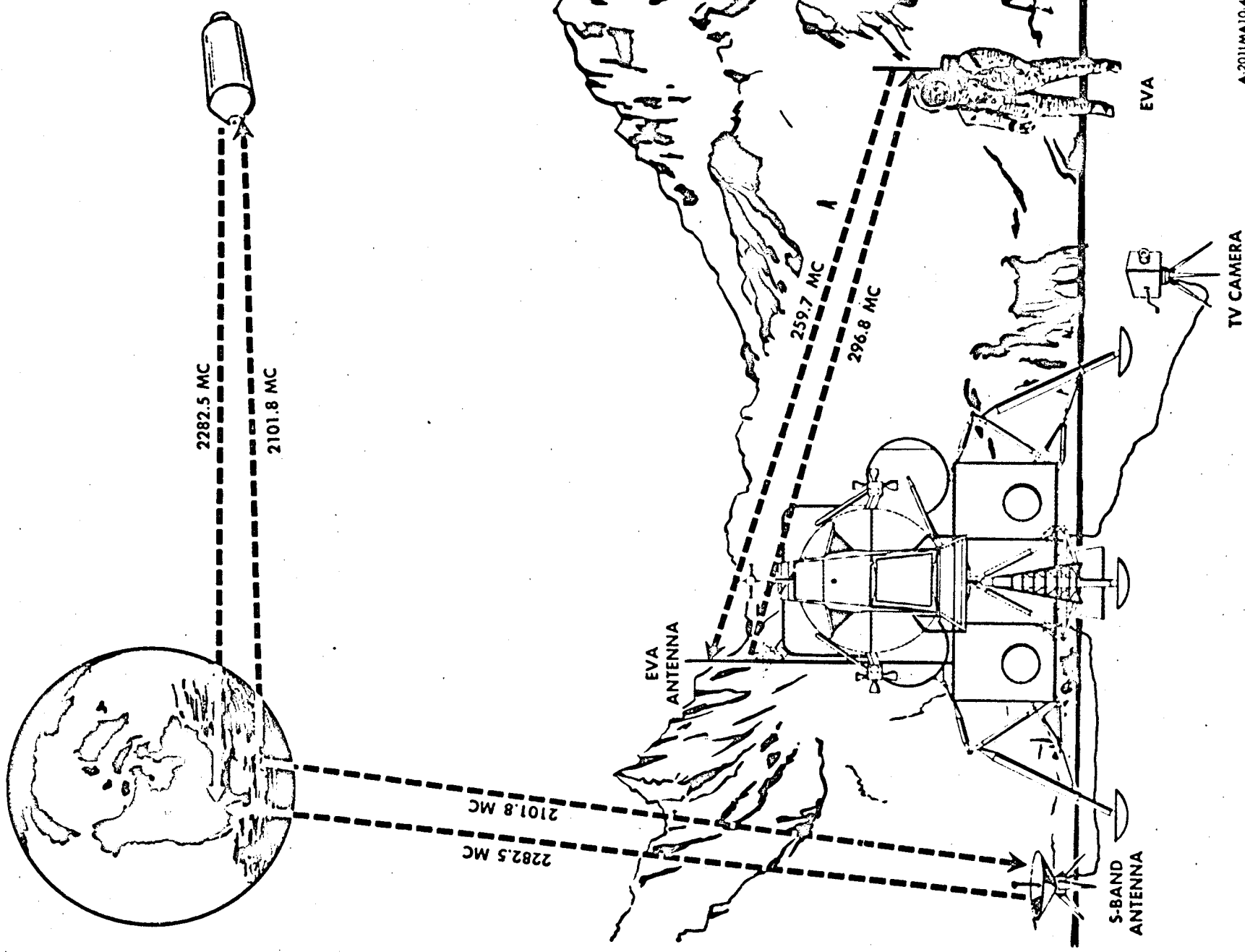

Figure 3-22. LEM Lunar Stay Communications

LEM-EVA voice transmission is a reversible duplex operation, the primary link being vhf transmitter A on 296.8 mc and receiver B on 259.7 mc; the secondary link is vhf transmitter B on 259.7 mc and receiver A on 296.8 mc. If the LEM-EVA primary link fails, the EVA must return to the LEM. During the EVA's return to the LEM, communications are switched to the secondary link. During operation of the primary link, EVA voice and EMU data are received on VHF B. EMU data cannot be transmitted from the EVA to the LEM during backup voice operation. The LEM vhf equipment is switched from in-flight antenna to EVA antenna during communication with the EVA. A diplexer permits use of the single antenna for both transmitters and receivers.

The lunar-stay LEM communications schedule requires operation of the S-band equipment to relay voice and biomedical and EMU suit data from the EVA to MSFN, to transmit voice and biomedical data from the astronaut in the LEM to MSFN, to transmit subsystem TM to MSFN, to transmit video from the extravehicular television camera to MSFN, and to receive voice originating from MSFN or CSM voice relayed to the LEM from MSFN.

S-band communications during lunar stay will be in one of two basic modes of operation: mode 1 is the high-power mode (20 watts); mode 2, the low-power mode (3/4 watt). Mode 1 transmission is a frequency-modulated carrier containing voice, biomedical and EMU data, PCM, and video. Mode 2 transmission is a phase-modulated carrier containing all signals, except video, used in mode 1 transmission. During lunar-stay an erectable antenna is used instead of the in-flight steerable or omnidirectional antenna. The EVA erects the S-band antenna on the lunar surface and installs the cabling provided to connect the antenna and the LEM rf.

The EVA sets up the television camera on the lunar surface utilizing an 80-foot cable to connect the TV camera to the LEM.

3-82. MSFN RADIO RELAY OPERATION.

The r-f carriers used for communications during all phases of the LEM mission are in the vhf and S-band ranges; these are LOS carriers and therefore limit communications to certain times during the LEM mission.

During lunar stay, the LEM has LOS with earth; LOS between the LEM and CSM occurs only while the CSM is above the lunar horizon with respect to the LEM. The prime mode of communication between the LEM and the CSM during lunar stay is the MSFN radio relay mode, in which MSFN is used as a radio relay station. During this operation, communication between the LEM and the CSM can be maintained as long as the CSM has LOS with earth. The time required for a radio transmission to traverse the distance between earth and the moon is 1.2 to 1.5 seconds; LEM astronauts calling the astronaut in the CSM via the MSFN radio relay must wait 4.8 to 6.0 seconds for the CSM reply, as compared to virtually instantaneous responses experienced during direct LOS LEM-CSM transmissions.

3-83. S-BAND COMMUNICATIONS.

The S-band section provides the LEM-earth communication link. All communication is accomplished during LOS phases of the mission. S-band communication consists of voice between the LEM and earth; biomedical data from the astronauts to earth; subsystem telemetry data to earth; tracking and ranging signals from earth, which are retransmitted to earth; television from within the LEM and of the lunar surface to earth; and emergency keying to earth when voice transmission to earth is lost.

The S-band section consists of a transmitter/receiver assembly, a power amplifier assembly, a diplexer, an r-f switch, two in-flight antennas, a steerable antenna, an erectable antenna, a television camera, and power supplies.

3-84. Transmitter/Receiver Assembly. The transmitter/receiver assembly contains two identical phase-locked receivers, phase modulators, and multiplier chains. These circuits permit ranging to the LEM by earth stations and transmission of voice, telemetry, biomedical, and EMU data from LEM to the ground station.

A frequency modulator is provided for video and EMU data transmission. It can also be used for voice and pulse code modulation/nonreturn to zero (PCM/NRZ) data transmission. The transmitter/receiver assembly consists of miniaturized solid-state circuits capable of producing an r-f output of 750 milliwatts minimum.

The S-band receivers receive voice and PRN ranging signals from MSFN during flight, and voice from MSFN during lunar stay. One receiver serves as a backup to the normally used unit. Received signals are routed from the S-band antenna to a receiver switch via the antenna r-f switch and diplexer. The receiver switch routes the received signals to the normally used receiver or to the backup S-band re-

ceiver. In flight, the received pseudorandom noise (PRN) signals are routed from the receiver to the operating phase modulator and are thereby relayed back to MSFN. Receiver voice outputs are fed via a summing network into the signal-processing section. During lunar stay, the PRN function is passive and voice from MSFN is processed in the same manner as in flight, from S-band receiver output to the astronaut headsets.

In-flight LEM-MSFN S-band communications require operation of the LEM PRN ranging transponder in addition to transmission of wide-band signals. A phase modulator receives PRN and wide-band inputs and generates a modulated subcarrier for input to a transmitter chain. The phase modulator derives wide-band modulation inputs from the signal-processing section via a summing network. These inputs are composite waveforms that consist of voice, telemetry, and biomedical signal components. The PRN ranging input to the phase modulator is derived directly from the output of the operating S-band receiver. Carrier-frequency multiplication and an increase in r-f power level are provided by the transmitter chain. The modulated r-f output from the transmitter chain is fed via a summing network to a power amplifier (PA) stage. A standby transmitter chain and phase modulator are also connected to the PA input via the summing network and are operated if normally used equipment fails.

The frequency modulator provides the wide-band signals for transmission from the LEM to MSFN during lunar stay, when the PRN ranging and tracking function is not required. The frequency modulator derives modulation inputs from the signal-processing section. These inputs consist of a composite waveform that contains telemetry, voice, and biomedical signal components. The output of the frequency modulator is a modulated subcarrier that is fed via a summing network to either S-band transmitter chain. A carrier-frequency multiplication occurs at this point in the transmitter chain, the power level is raised in the operating PA, and output power is fed through the diplexer and r-f switch to the S-band erectable antenna.

3-85. Power Amplifier. The power amplifier provides power amplification at 2282.5 mc. The assembly consists of two dc-to-dc converter power supplies, two amplifiers, an input isolator, and an output isolator. The r-f circuit is a series interconnection of the isolators and two amplifiers. Each amplifier is connected to its own power supply; only one amplifier operates at a given time. When neither amplifier is operating, they provide a low r-f loss feedthrough path directly to the antenna.

3-86. Diplexer and R-F Switch. The diplexer permits forward flow of transmitter power to the selected S-band antenna simultaneously with reception of low-level MSFN PRN and voice signals. The r-f switch, on the control panel, is manually operated by the astronaut to select the desired antenna.

3-87. Antennas. The in-flight antennas are omnidirectional antennas matched to the output of the transmitter through the r-f switch. They are forward and aft of the center of the LEM and have right-hand circulator polarization.

The steerable antenna is a medium-gain, unidirectional antenna that provides hemispherical coverage around the LEM +X-axis. It is mounted on the LEM on a double elevation gimbal that is servo-controlled in response to automatic or manual slewing control signals, and is used during lunar orbit, descent, lunar stay, ascent, rendezvous, and docking. The Systems Engineer uses the antenna-positioning controls on his communications ANTENNAS control panel to point the antenna toward the earth where the automatic tracking system can take over. The antenna gimbal attitude is indicated (in degrees) on two panel instruments. A third panel indicator monitors received S-band signal strength; indicator readout in volts and maximum readout as a function of optimum antenna attitude. Subsequent to manual acquisition of optimum antenna attitude, the Systems Engineer selects the automatic track mode of operation for the steerable antenna. In this mode, an r-f sensor derives tracking-error signals that are applied to the steerable antenna servo drive unit to alter antenna attitude automatically and continuously for maximum reception of S-band transmission from MSFN.

The erectable antenna is a high-gain unit that consists of a helix-fed parabolic reflector mounted on a tripod support and provided with an optical telescope. The erectable antenna is used during lunar stay, for S-band communications between the LEM and MSFN stations. When the LEM is on the lunar surface, the EVA removes the erectable antenna from the LEM descent stage, erects the antenna some distance from the LEM, and aims it towards earth. The antenna can be adjusted to the slope of the lunar terrain and to the position of the earth in the lunar sky. The EVA connects the deployable r-f cable from the erectable antenna to the LEM S-band output termination. The EVA can carry and assemble the antenna and connect the deployable cable up to 25 feet from the LEM site; no equipment or tools are needed for assembling, erecting, or pointing the antenna.

3-88. S-Band Power Supplies. The S-band section contains four power supply units. One phase modulator-transmitter chain receiver combination obtains power from a single associated supply; a similar supply operates the other receiver phase modulator-transmitter chain combination. Either

of the two supplies can be selected with a power supply switch to operate the frequency modulator during lunar stay. The two amplifier-type PA's are operated by individual power supplies.

3-89. Television Camera Equipment. A portable television camera permits high-resolution images of the LEM (inside and outside) and of the lunar surface to be transmitted to earth. An 80-foot cable provides power to the television camera and returns the video signal to the LEM. The video signal is fed directly to the S-band frequency modulator in the LEM.

3-90. VHF COMMUNICATION.

The vhf section provides communications between the LEM and the CSM, and between the LEM and the EVA during lunar stay. It also is used to receive EMU and biomedical data and transmit this data to the CSM. The vhf section consists of a transmitter-receiver assembly, diplexer and an antenna selector switch, two in-flight antennas, and an EVA antenna.

3-91. Transmitter-Receiver Assembly. The vhf transmitter-receiver assembly is an all-solid-state device that contains two a-m transmitters, two a-m receivers, and a diplexer. The transmitter-receiver combinations provide a 296.8-mc channel and a 269.7-mc channel. Each transmitter-receiver combination permits simplex operation; that is, transmission from the LEM to the CSM and reception by LEM of transmission from the CSM on the same frequency. The primary LEM-CSM link provides for a-m voice on 296.8 mc; the backup link, for a-m voice on 259.7 mc. A simplex transmit capability provides for LEM-CSM transmission of pcm data on 259.7 mc. The unit can also provide duplexer LEM-EVA voice transmission on 296.8 mc and EVA-LEM voice and biomedical data reception on 259.7 mc. Either of the vhf channels can be controlled remotely.

3-92. Diplexer and Antenna Selector Switch. The diplexer is mounted as part of the transmitter-receiver assembly and permits the receivers and transmitter to use the same antenna, although the transmitters and receivers are not operating on the same frequency. The antenna selector switches are operated by an astronaut at the COMMUNICATIONS ANTENNAS control panel and permits selection of the desired antenna.

3-93. Antennas. The vhf section contains two omnidirectional antennas for use during the in-flight portions of the mission. They are circularly polarized and are matched to the feed source. The section also contains a vertically polarized antenna mounted on the LEM for use when communicating with the EVA during the lunar stay.

3-94. VHF Transmission. The two transmitters in the vhf section derive voice modulation and carrier turn-on control signals from the audio centers in the signal-processing section. Carrier turn-on is initiated by voice-actuated key (VOX) or operation of push-to-talk (PTT) switches. One audio center is connected to the Commander's EMU microphone circuit and to the modulation inputs of the vhf transmitter; another audio center is connected the same way for the Systems Engineer. The modulation input to channel B transmitter can be switched from voice to PCM by the astronauts. The PCM signals are received from the pulse code modulation and timing equipment (PCMTE) in the LEM Instrumentation Subsystem. The outputs from the transmitters are routed to the antenna selector switch and to the antenna via a diplexer unit that permits operation of any vhf transmitters or receivers on a single antenna. In flight, the Systems Engineer uses the antenna selector switch on the COMMUNICATIONS ANTENNAS panel of his lower side console to select either omnidirectional in-flight antenna. This switch also permits switching the diplexer output to the EVA antenna or to the pregress check circuit before and during an EVA activity. Telemetry data consisting of low-bit-rate PCM data are transmitted to the CSM, where they are recorded and subsequently played back to earth.

3-95. Modulation. The LEM vhf transmitters use infinitely clipped speech modulation whereby speech waveforms are reduced to square waves that pulse the transmitter on and off. A 30-kc signal is introduced within the amplitude limiters to capture the system during intersyllable pauses in speech and in the absence of speech input. In addition, the higher frequencies of the speech spectrum are emphasized to improve intelligibility.

3-96. VHF Reception. The two receiver circuits in the vhf section derive inputs from the diplexer via transmit-receive (T/R) switches. The receiver portion of channel B is tuned to the EVA duplex frequency (259.7 mc). The receiver portion of channel A is tuned to the CSM simplex frequency (296.8 mc). The outputs from both vhf receivers are fed into both audio centers from the signal-processing section.

3-97. Pregress Checkout and EVA Communications. Before leaving the LEM, the EVA checks his PLSS vhf communications equipment for proper operation with the LEM, CSM, and MSFN. Because use of the telescoping antenna is not practicable inside the LEM, a test cable is used to transmit the modulated r-f carrier from the PLSS antenna network to the LEM antenna network. The test connector on the PLSS is internally wired to the PLSS whip via a coaxial tee fitting. The test cable has sufficient

attenuation to simulate normally received signal strength at the EVA antenna; the LEM test receptacle feeds the test-cable-attenuated input into the LEM vhf section via the antenna selector switch. The following switching required for pregress checkout are made at the Audio Control panels: the LEM vhf switch is set to PRE-EGRESS CHECK, and the EVA PLSS is activated. The EMU-to-PLSS cable carries EVA voice, biomedical, and EMU-environment signals from the EMU microphone and sensor networks to PLSS mixer circuitry. The PLSS duplex and simplex units are exercised during the pregress procedure, thereby ensuring proper operation of the EVA-LEM, EVA-CSM, and EVA-MSFN communication links. The first pregress checkout uses the S-band steerable antenna or either S-band omnidirectional antenna; after the erectable antenna is set up on the lunar surface and its cables connected to the LEM, this antenna is used for all subsequent S-band operations, including pregress checkouts.

3-98. SIGNAL-PROCESSING ASSEMBLY.

The signal-processing assembly (SPA) may be considered the focal point of the Communications Subsystem. All signals transmitted or received by the subsystem are processed by the signal processor. The SPA receives voice and biomedical data from each astronaut and processes this information so that the vhf and S-band transmitters may be modulated by the proper signals for communications with the command module, earth, and the EVA. It also permits the Communications Subsystem to be used as a relay station so that the EVA or CSM vhf signals can be transmitted to earth via the S-band equipment. In addition, the signal processor provides voice-conference capability between the EVA, the astronaut inside the LEM, the CSM, and earth.

Received voice and voice biomed data are obtained from the vhf and S-band receivers, processed, and the desired signals selected for retransmission via S-band or vhf. The voice portions are routed to the astronauts' headphones. The SPA also processes pcm-nrz data and video signals and applies this information to the proper subcarrier for phase or frequency modulation of the S-band transmitter. For emergency conditions, the signal processor provides direct voice modulation of the S-band transmitter and a subcarrier that may be keyed for code transmission.

The SPA contains premodulation processing circuits that consist of filters, subcarrier oscillators, mixing networks, switching circuits, and audio-processing circuits, which provide isolation, switching, and amplification of voice signals. The audio-processing circuits contain two audio centers: one for the Commander; the other, for the Systems Engineer. Each audio center enables the operator to monitor individual signals.

3-99. ELECTRICAL POWER SUBSYSTEM. (See figure 3-23.)

The Electrical Power Subsystem (EPS) provides electrical power to all circuits in the LEM. The power originates at two batteries in the ascent stage, and four batteries in the descent stage. The batteries are installed and activated 16 hours before launch. The power distribution section in the ascent stage is critical for astronaut survival. Therefore, each ascent battery can supply the total ascent loads during an abort. The power distribution section in the descent stage is critical for mission performance. All four descent batteries are required to perform the complete mission; however, a curtailed mission can be performed using three descent batteries. If two descent batteries fail, the mission must be aborted. The EPS consists of a d-c section and an a-c section.

3-100. D-C SECTION. (See figure 3-24.)

The d-c section consists of four silver-zinc descent batteries, two silver-zinc ascent batteries, two descent electrical control assemblies (ECA's), two ascent ECA's, a relay junction box, several relays, a control panel, abort logic, descent ECA/battery logic control, and two circuit breaker panels.

3-101. Descent Batteries. Four 28-volt d-c descent batteries, rated at 400 ampere hours, supply power to the LEM during a normal mission from T-30 minutes to lunar ascent, except during translunar coast. In the event of a battery failure, curtailed mission objectives may be pursued with the three remaining descent batteries. Due to the inherent initial high-voltage characteristics of the descent batteries a tap is provided at the 17th cell of each 20-cell descent battery.

3-102. Ascent Batteries. The two 28-volt d-c ascent batteries, rated at 400 ampere hours, are used during a normal mission from powered ascent to docking or during an abort requiring separation of the ascent stage. To eliminate the initial high-voltage characteristics of these batteries, they will be pre-discharged under controlled conditions before installation.

3-103. Descent Electrical Control Assemblies. Each descent electrical control assembly (ECA) protects and controls two descent batteries and their respective wiring. Protective circuits automatically disconnect a descent battery in the event of an overcurrent and provide an indication on the Electrical

Figure 3-23. Electrical Power Subsystem Equipment Location

A-201MA10-48

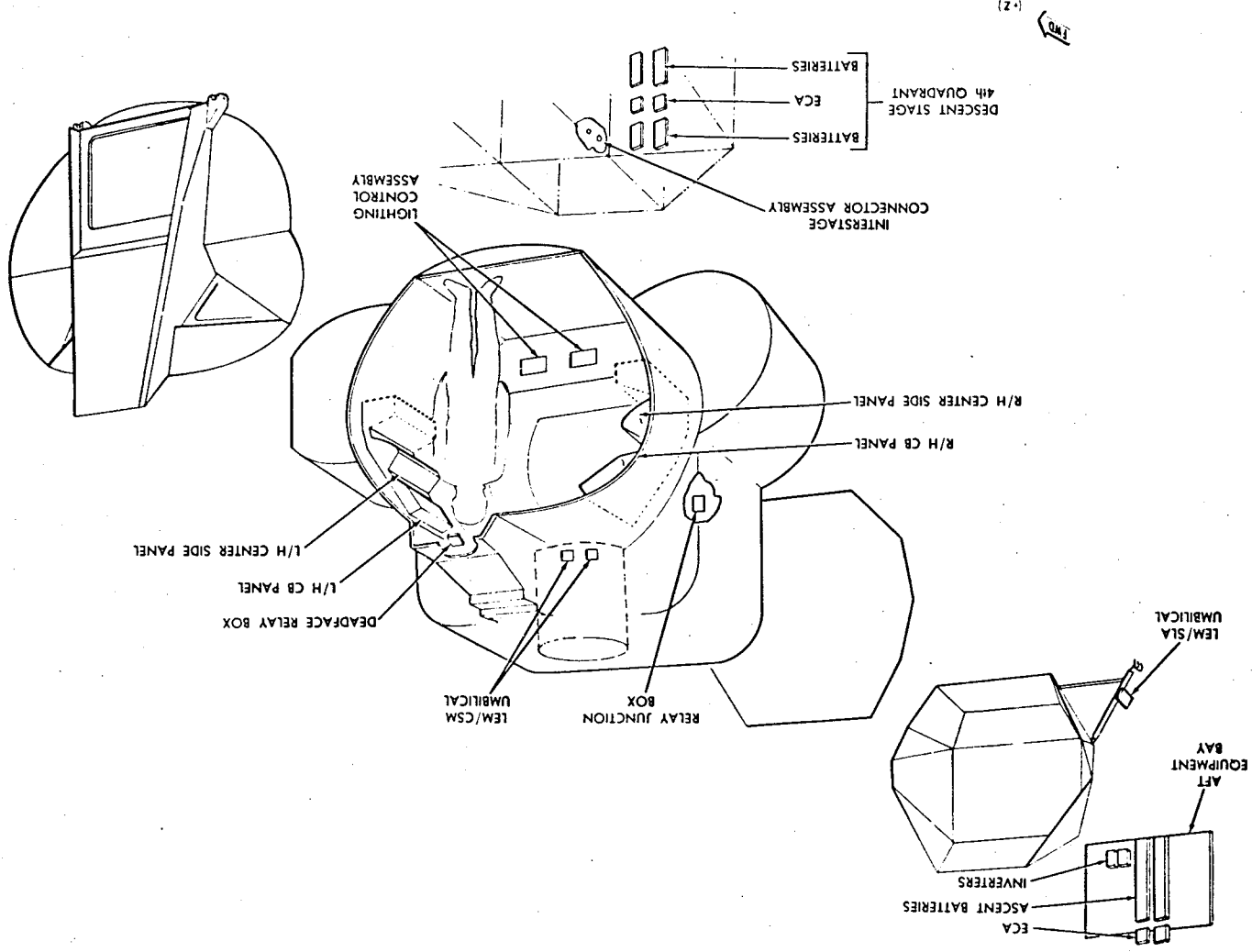

LMAT90-1

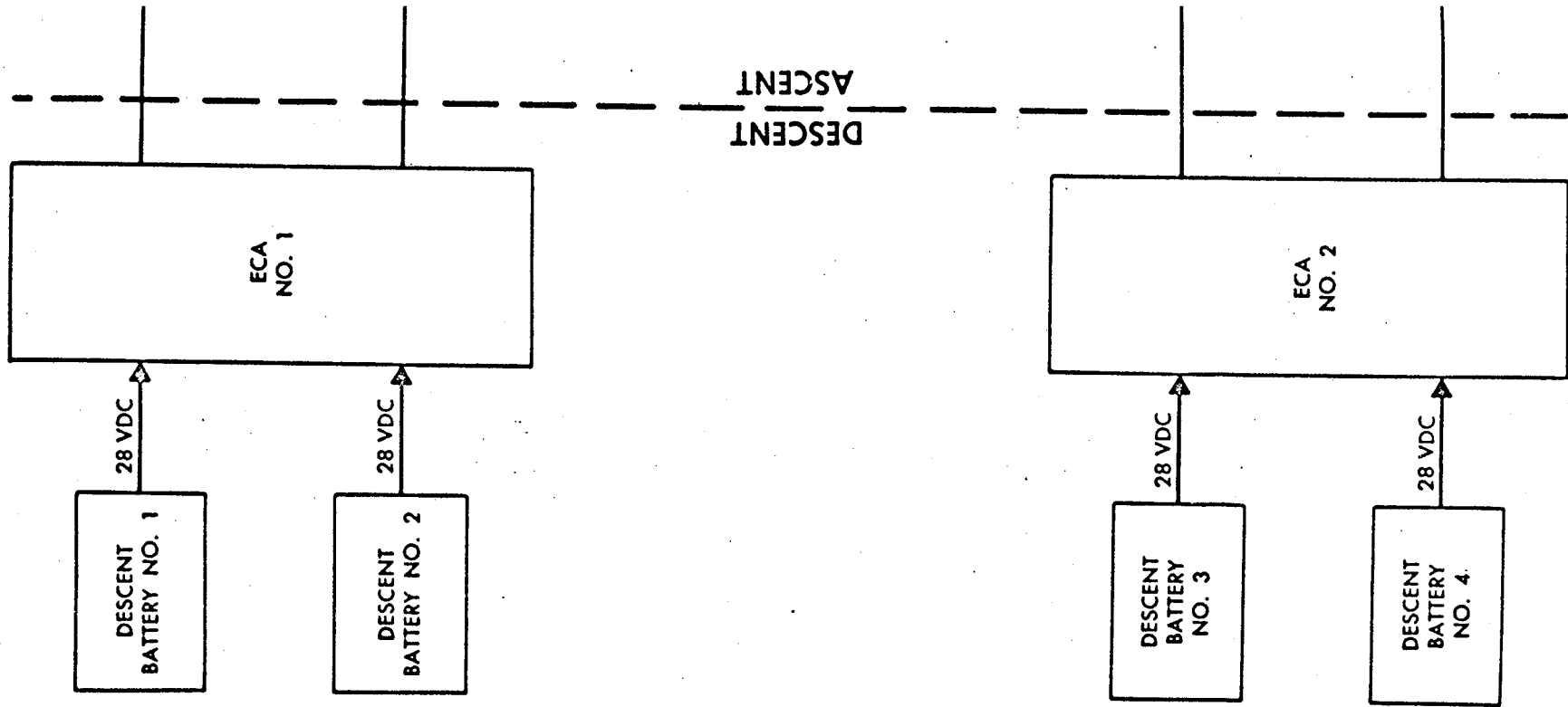

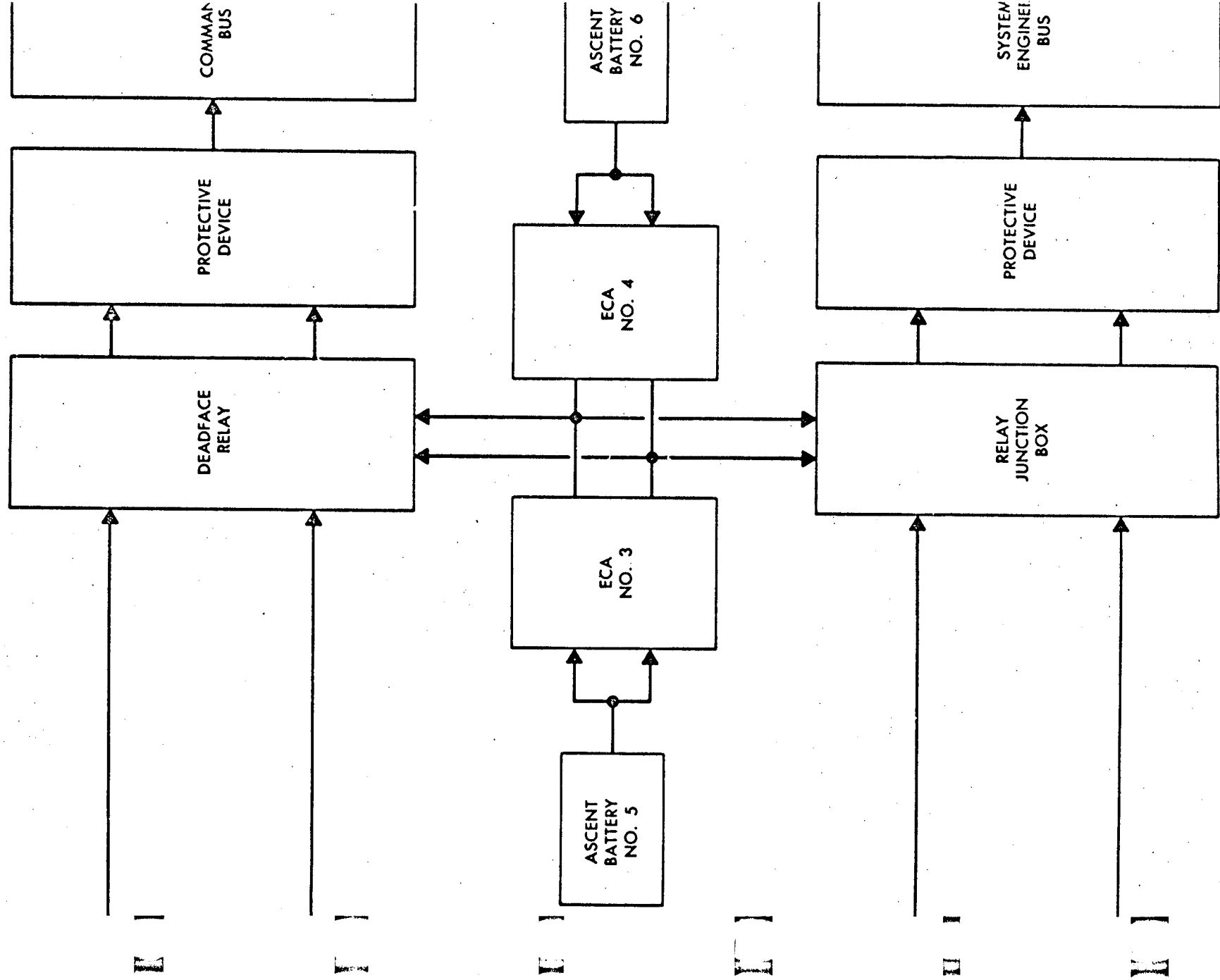

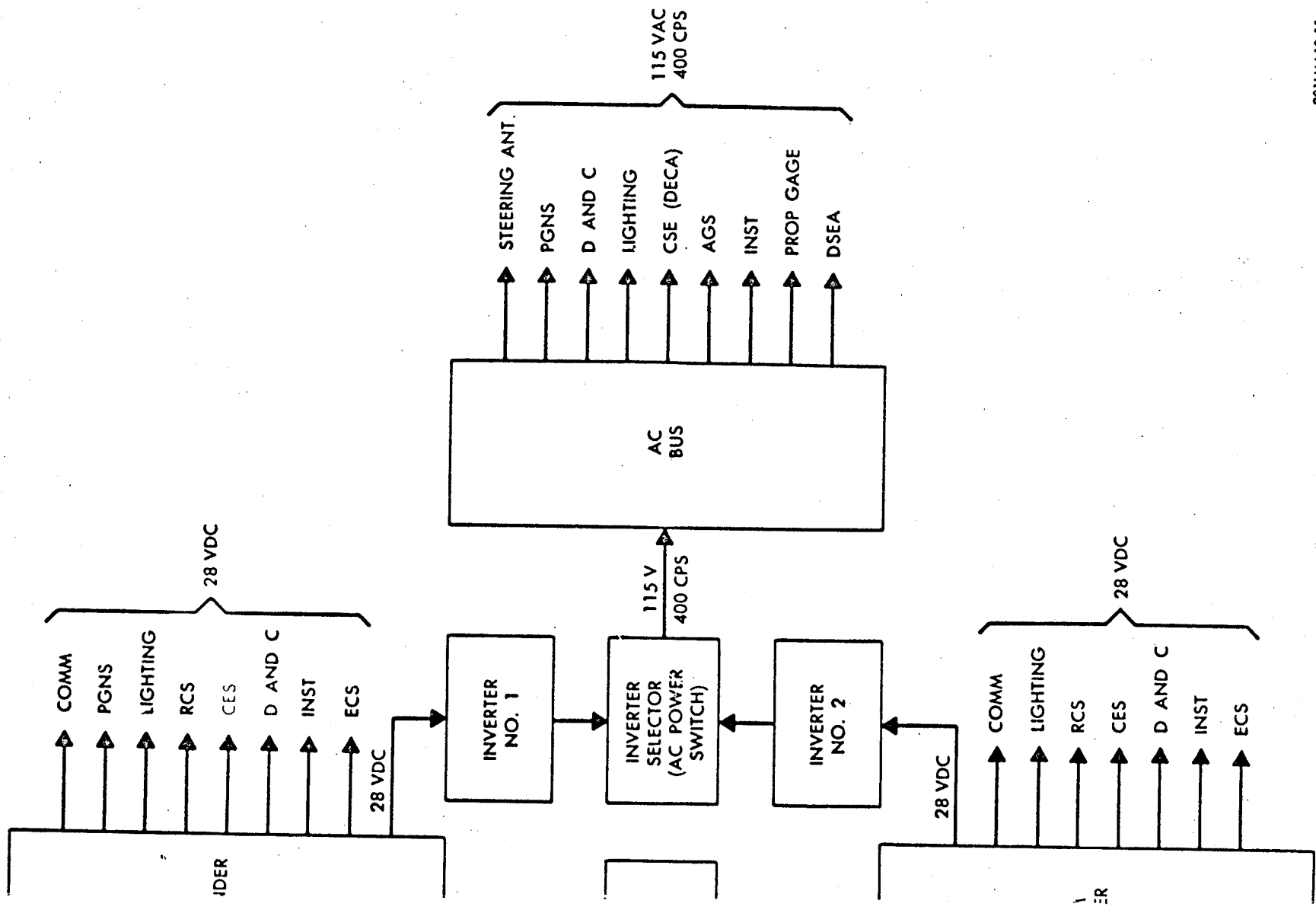

Figure 3-24. Electrical Power Subsystem Function Block Diagram

Power Subsystem (EPS) panel when reverse current exists. When this overcurrent condition occurs, manual reset of the protective circuits is required; when reverse current occurs, its indication will require manual correction at the EPS panel. Control circuits provide on-off control of two contactors that connect each descent battery to the system wiring. Interlocks preclude simultaneous operation of both contactors. Current flow control, voltage monitoring, and distribution logic, are part of the descent ECA's.

3-104. Ascent ECA's. An ascent ECA protects and controls each ascent battery. The protective circuits are similar to those of the descent ECA's. Two contactors enable on-off control of current flow from each battery to separate feeder systems. This enables use of the battery in the event of a feeder failure, or use of a feeder in the event of a battery failure. Battery current-flow control, voltage monitoring, and distribution logic are provided.

3-105. Relay Junction Box. The relay junction box (RJB) provides logic and junction points for connecting external power to the LEM from the CSM and the launch umbilical tower (LUT). In addition, the RJB provides control and power junction points for the ascent and descent ECA's and deadfacing for half of the main power cables between ascent and descent stages; the other half is handled by the deadface relay.

3-106. Descent ECA/Battery Logic Control. The descent ECA/battery logic control provides individual control of a low voltage contactor (LVC) and a main feed contactor (MFC), from the ELECTRICAL POWER CONTROL panel; simultaneous control of the on-off circuitry from all LVC's, from LUT; simultaneous control of the on-off circuitry of all LVC's, from the CSM; and simultaneous off signals to the MFC's, from abort logic.

3-107. Abort Logic. Two redundant relays to maintain voltage are energized upon receipt of an abort signal, and immediately provide logic for switching from descent to ascent batteries.

3-108. Relay Junction Box Deadface Relay. The relay junction box (RJB) deadface relay is a latching type dpst on-off switch on the ELECTRICAL POWER CONTROL panel; it is automatically opened by (paragraph 3-111) the abort logic. This relay, in conjunction with the deadface relay, provides the deadfacing for the main power lines between ascent and descent stages.

3-109. CSM Deadface Relay Interface Logic. Two redundant latching relays connect power from the CSM to the LEM during translunar operation. An interlock prevents the LEM and CSM power supplies from being on simultaneously.

3-110. Launch Umbilical Tower Relay. The launch umbilical tower (LUT) relay is a dpst latching relay controlled from ground support equipment. This relay is used to connect ground power to the LEM when the LEM EPS batteries are not in use.

3-111. Deadface Relay. The deadface relay (DFR) is a dpst latching relay with contacts that operate in conjunction with the RJB deadface relay contacts to provide the deadfacing of the main power lines between the ascent and descent stages. The deadface relay operates in parallel with, and from the same controls and logic as the RJB deadface relay, the manual on-off switch from ELECTRICAL POWER CONTROL panel, and the automatic off signal from the abort control logic.

3-112. Control Panel. (See figure 3-2.) Control of the EPS is provided at the ELECTRICAL POWER CONTROL panel on the Systems Engineer's center side console.

3-113. Circuit Breaker Panels. Two d-c busses (one each at the Commander's and Systems Engineer's panels) are connected by the ascent feeder wire system. Redundant or functionally redundant equipment is placed on different busses, enabling each bus to perform an abbreviated abort mission should it become necessary.

3-114. A-C SECTION. (See figure 3-24.)

The a-c section uses two single-phase, 115-volt, 400-cps, 350-volt-ampere inverters. An a-c bus in the a-c section distributes power to LEM equipment that requires alternating current.

3-115. ELECTRICAL POWER SUBSYSTEM OPERATION.

After the batteries are installed in the LEM on the launching pad, the power distribution section (PDS) and batteries are checked. After checkout, the LVC switches on the ELECTRICAL POWER CONTROL panel for each descent battery are momentarily set to ON and the AUTO TRNFR switch is set to INHIBIT. This allows external control of the descent batteries and inhibits the use of ascent batteries by LUT. GSE power is supplied to the LEM until T-30 minutes, at which time the descent batteries

are connected to the LEM distribution system. The descent batteries power the LEM from T-30 minutes until transposition and docking. After transposition and docking, the descent batteries are shut down through use of CSM control and the RJB logic. The LEM is then powered by the CSM. During this translunar phase, the negative return for the LEM loads is transferred from the LEM single-point ground to that of the CSM. In lunar orbit, before preparation checkout, the power source is transferred from the CSM to the LEM descent batteries. All preparation checkout power is supplied by the LEM batteries. Manual switchover to the 20-cell taps of the descent batteries occurs during preparation checkout. Each ascent battery and the PDS is checked out during this phase. To control descent power during parallel operation of ascent and descent batteries, the deadfacing switch can be used. The descent batteries are used through lunar stay; the ascent batteries are used from a period just before lunar ascent through docking of the LEM with the CSM after lunar launch. Any of the following failures in the EPS is reason for an abort: failure of any two descent batteries, any feeder short, failure of either ascent battery, bus failure, loss of control for either ascent battery or for any two descent batteries. A descent battery failure is indicated by reverse current and causes a caution indicator on the ELECTRICAL POWER CONTROL panel. Manual shutdown of the battery extinguishes the indicator, and a curtailed mission is possible. Failure of a second descent battery is cause for an abort requiring manually turning on of the ascent batteries, and shutting down the remaining two descent batteries. If, during periodic checks of the ascent batteries, a failed battery is detected, an abort condition exists. Each ascent battery can be connected to two separate feeders (normal and alternate conductors). If an ascent battery fails, the other battery is connected to both feeder systems. A feeder short, while operating on the descent batteries, automatically removes the two descent batteries associated with the shorted feeder. This occurs after the shorted feeder is isolated from a bus by a diode-circuit breaker arrangement. Logic within the ECA's causes both ascent batteries to be connected to the other feeder system. Similarly, when operating on two ascent batteries, a shorted feeder can be isolated. However, manual operation is required to connect the ascent battery associated with the shorted feeder to the other feeder system. A shorted bus is isolated from the batteries automatically.

When the ABORT STAGE switch is pressed, two isolated signals (only one signal is needed) are applied to the abort relays in the RJB, causing the following sequence of events to occur automatically: the RJB abort relays are energized, the ascent batteries are connected to the distribution network, the four descent batteries are disconnected from the distribution network, deadface relays open the main power lines between the ascent and descent stages, and the abort relays are deenergized.

At the start of the preparation checkout, inverter No. 1 is energized by closing its circuit breaker on the EPS bus; its output is then connected to the a-c bus by setting the AC PWR switch on the ELECTRICAL POWER CONTROL panel to INV 1. The AC PWR switch is used to select inverter No. 1 or No. 2 through separate feeder lines to the a-c bus, or to external power before earth launch.

If inverter No. 1 fails, or a feeder shorts (indicated by the caution lights at the EPS panel) the AC PWR switch must be set to INV 2. Setting the AC BUS FEED TIE circuit breaker then restores power to the a-c bus.

3-116. ENVIRONMENTAL CONTROL SUBSYSTEM. (See figures 3-25 and 3-26.)

The Environmental Control Subsystem (ECA) consists of five integrated sections: Atmosphere revitalization, oxygen supply and cabin pressure control, heat transport, water management, and cold plate. The major portion of the ECS is in the pressurized compartment in the ascent stage. The glycol loop and two gaseous oxygen tanks for the ECS are in the ascent stage in the aft equipment bay; a third (larger) gaseous oxygen tank is located in the descent stage. Two ECS water tanks are in the tankage section of the ascent stage; a third (larger) water tank is in the descent stage.

The ECS controls the oxygen for pressurization and ventilation of the cabin and the pressure garment assembly (PGA) worn by the two astronauts, and cabin and PGA temperature. It provides breathing oxygen for the portable life support system (PLSS) and the cabin, limits the level of carbon dioxide, removes odors and moisture from the PGA and particulate matter from the oxygen breathed by the astronauts, and automatically controls the temperature of the electronic equipment. The ECA also stores water for drinking, food preparation, and the PLSS.

3-117. ATMOSPHERE REVITALIZATION SECTION.

The atmosphere revitalization section (ARS) conditions and provides oxygen to cool and ventilate the PGA and monitors cabin oxygen recirculation and temperature. The atmosphere revitalization section monitors the carbon dioxide level of the atmosphere breathed by the astronauts, removes odors and noxious gases from this atmosphere, removes foreign objects and particulate matter that originate within the LEM, removes excess moisture from the cabin atmosphere to maintain a relative humidity of 40% to 70%, and controls the oxygen temperature and flow through the PGA.

Figure 3-25. Environmental Control Subsystem Installation

A2010A10-50

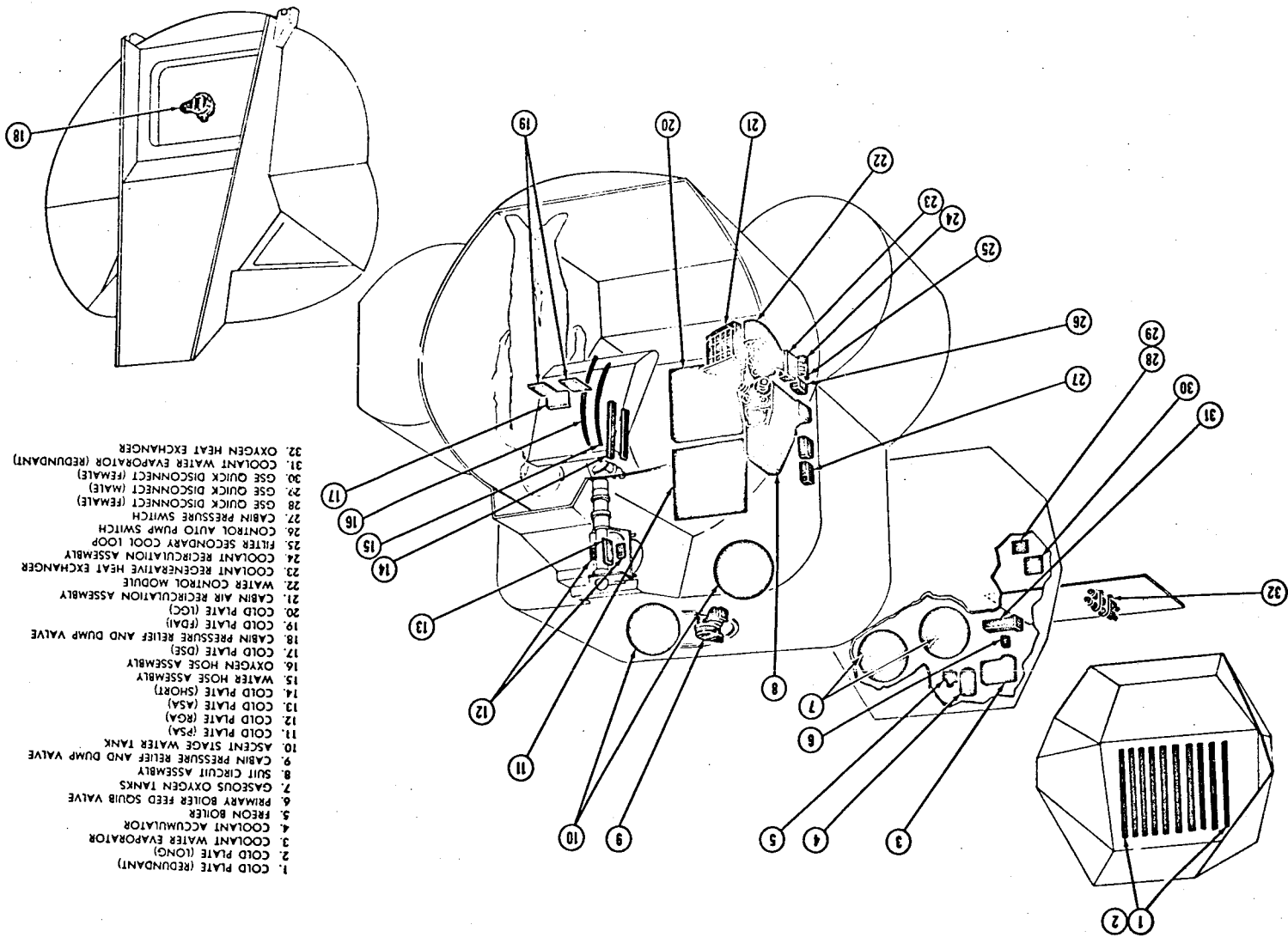

LMA790-1



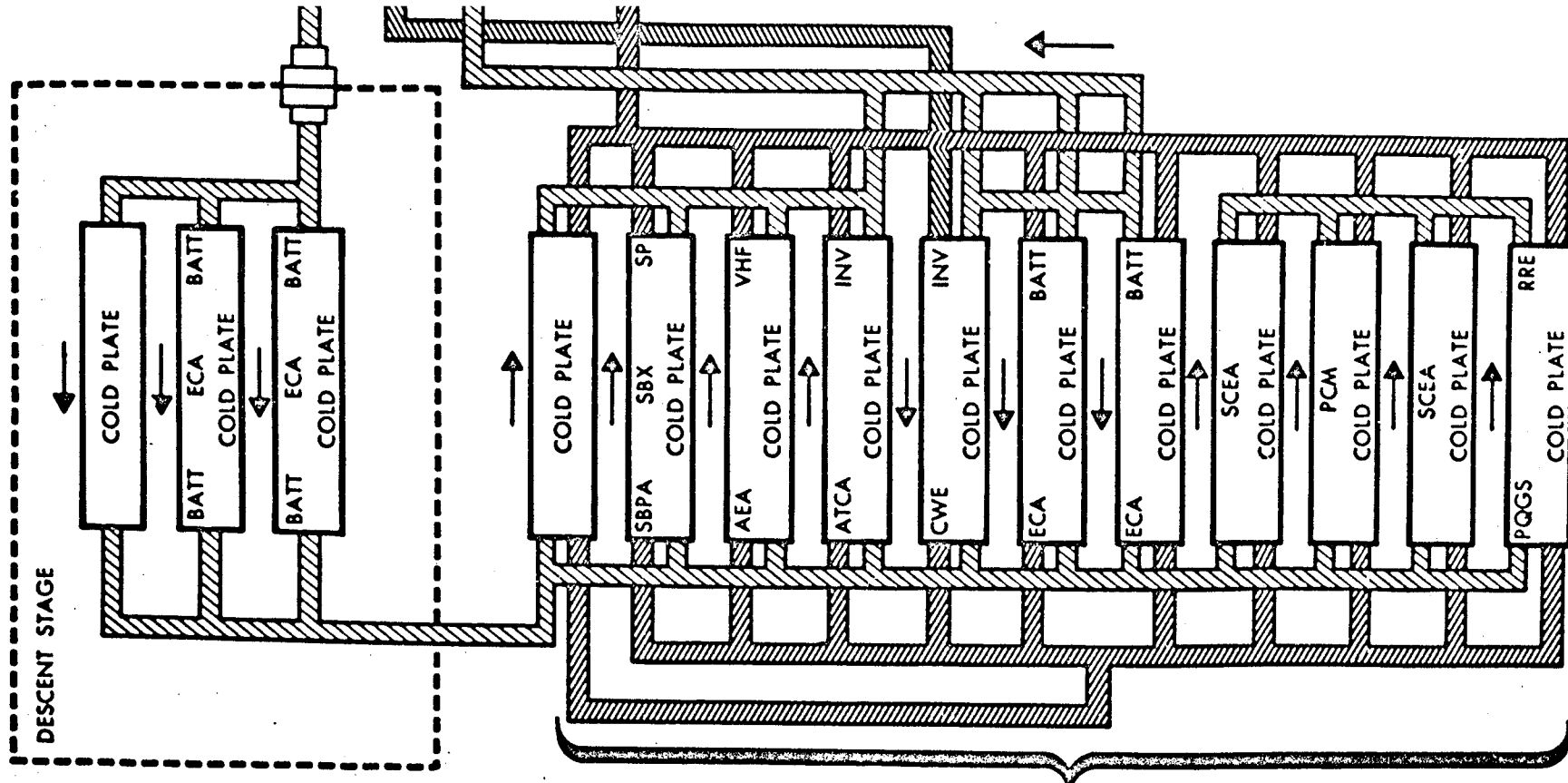

AFT EQUIPMENT BAY AREA (ASCENT STAGE)

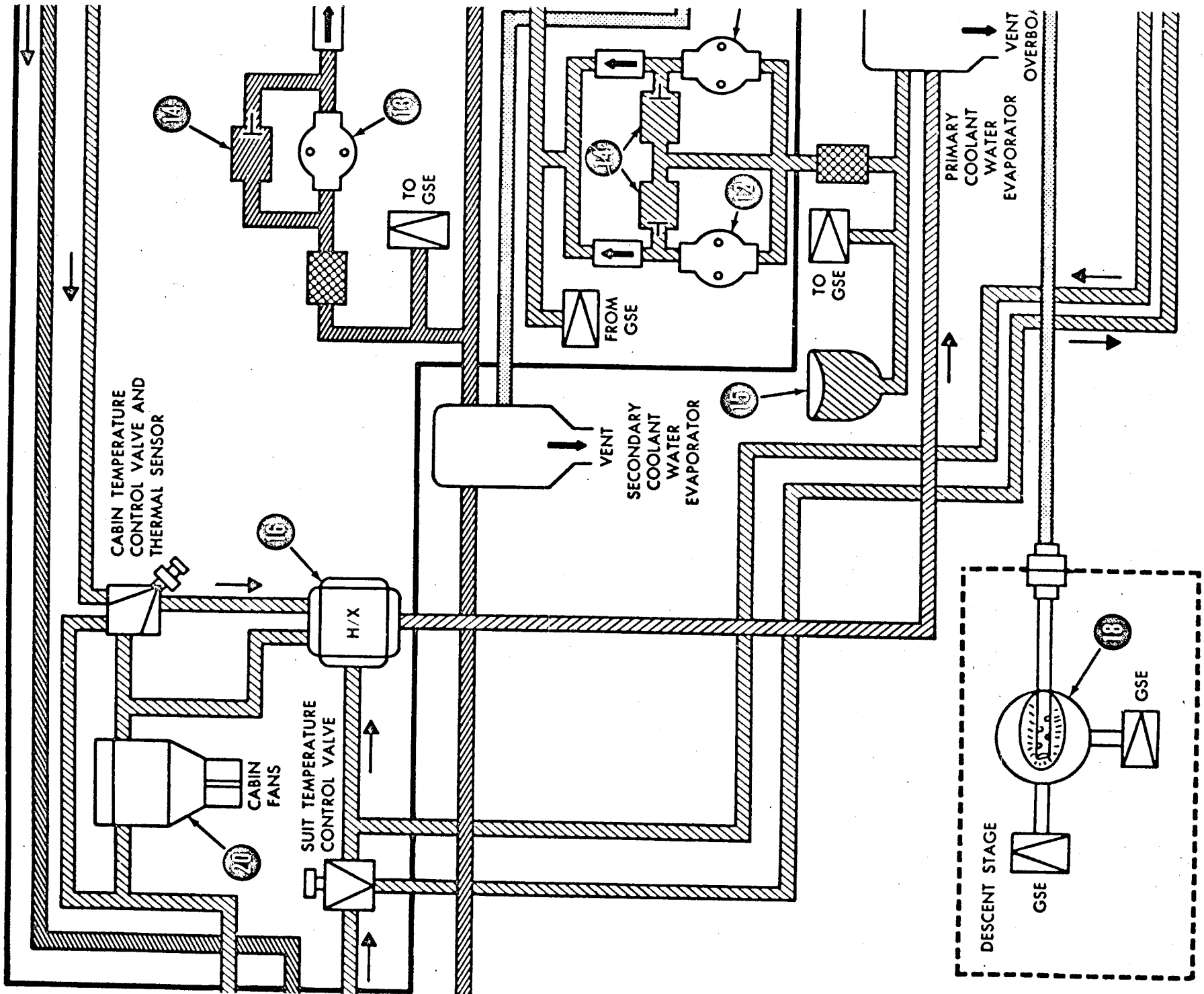

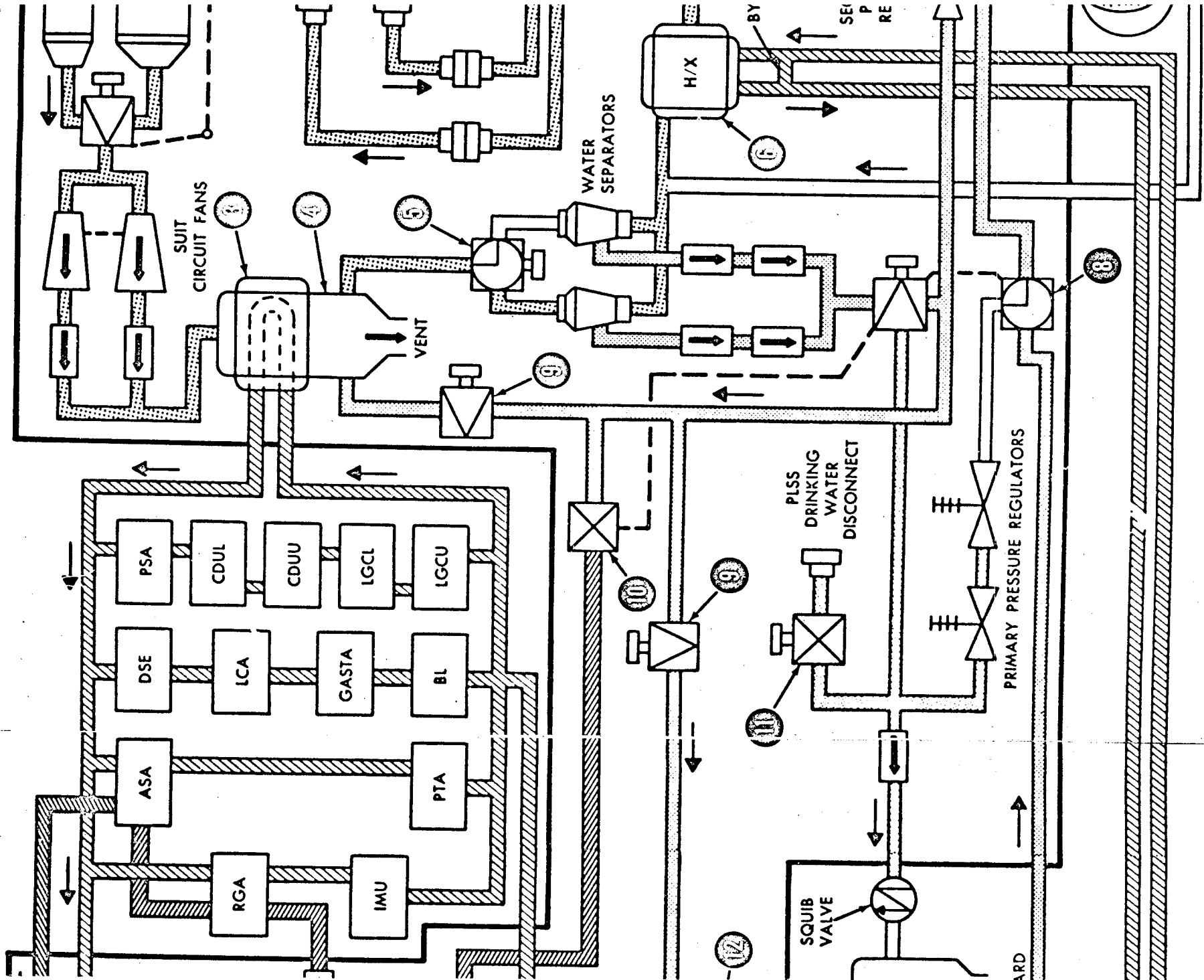

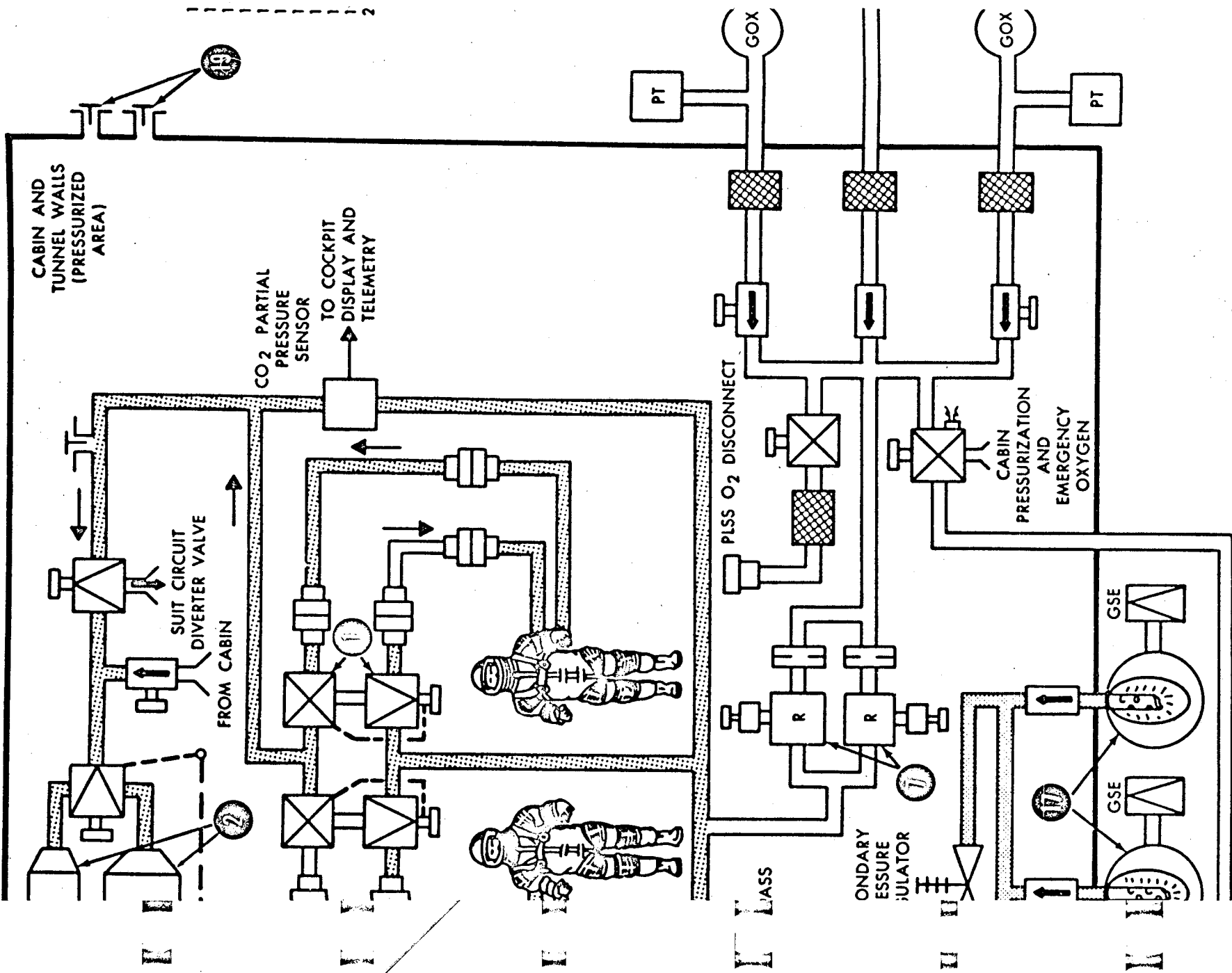

- 1. SUIT FLOW CONTROL VALVES
- 2. CO₂ AND ODOR REMOVAL CANNISTERS
- 3. SUIT CIRCUIT HEAT EXCHANGER
- 4. SUIT CIRCUIT WATER EVAPORATOR (EMERGENCY WATER BOILER)
- 5. WATER SEPARATOR SELECTOR VALVE
- 6. SUIT CIRCUIT REGENERATIVE HEAT EXCHANGER
- 7. OXYGEN DEMAND REGULATOR
- 8. WATER TANK SELECTOR VALVE
- 9. WATER EVAPORATOR MANUAL FEED VALVE
- 0. WATER-COOLANT ISOLATION VALVE
- 1. WATER SHUTOFF VALVE
- 2. PRIMARY COOLANT PUMP
- 3. SECONDARY COOLANT PUMP
- 4. RELIEF VALVE
- 5. COOLANT ACCUMULATOR
- 6. COOLANT REGENERATIVE HEAT EXCHANGER
- 7. ASCENT STAGE WATER TANK
- 8. DESCENT STAGE WATER TANK
- 9. CABIN PRESSURE RELIEF AND DUMP VALVE
- 0. CABIN HEAT EXCHANGER

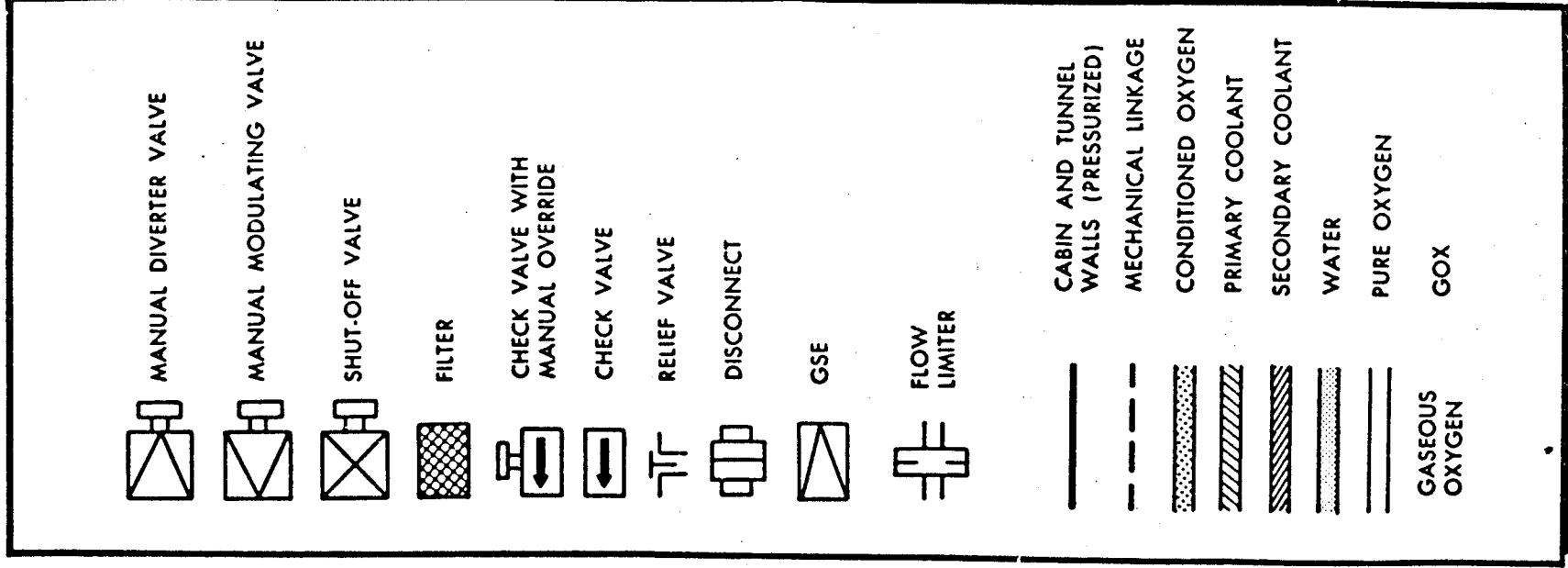
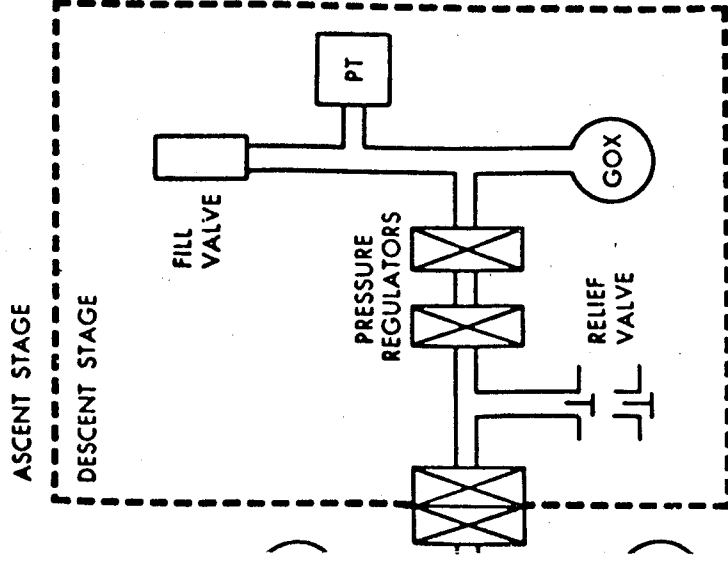

B-201UMAT0-11

Figure 3-26. Environmental Control Subsystem Schematic

The ARS consists of a cabin recirculation assembly, two suit circuit fans (one redundant), a suit circuit heat exchanger and water evaporator, and two water separators (one redundant). In addition, the ARS contains a regenerative heat exchanger; a carbon dioxide partial pressure sensor; two carbon dioxide and odor removal canisters, each consisting of a canister and replaceable cartridge; a relief valve; check valves; and interconnecting tubing.

Oxygen from the oxygen supply and cabin pressure control section (OSCPCS) is circulated through the ARS by one of the two suit circuit fans. Because either fan can maintain the required suit circuit oxygen flow, only one fan is operated at a time. After leaving the fan, the oxygen passes through the suit circuit heat exchanger, which transfers excess heat from the oxygen to the heat transport section coolant. The suit circuit water evaporator removes the excess heat if the suit circuit heat exchanger fails. Excess moisture that condenses when the oxygen passes through the suit circuit heat exchanger or suit circuit water evaporator is removed from the oxygen by one of the two water separators. Each separator can meet the water removal requirements but, depending on the position of the manually operated water separator selector valve, only one separator functions at a time.

Downstream of both water separators is the suit circuit regenerative heat exchanger, which permits the oxygen temperature to be manually controlled by the astronaut before the oxygen enters the PGA. Warm coolant from the heat transport section flows through the heat exchanger, transferring heat to the oxygen. The oxygen temperature is controlled by varying the flow of coolant through the heat exchanger; the astronaut manually controls this flow with the suit temperature control valve. In addition, the astronauts control their comfort with their individual flow control valve. The carbon dioxide partial pressure sensor monitors the partial gas pressure due to carbon dioxide, at a safe partial pressure level. The partial pressure is displayed on the environmental control panel at the system engineer's center panel. The oxygen then passes through one of the two carbon dioxide and odor removal canisters, into a suit circuit fan. The cycle is repeated.

During open-faceplate operation (normal pressurization level), the suit circuit diverter valve is opened to pass the entire oxygen flow from the ARS of the suit circuit assembly into the cabin. This ensures that sufficient cabin oxygen is circulated through the ARS to maintain the desired carbon dioxide and humidity levels in the cabin. In the event of depressurization of the cabin atmosphere, the cabin pressure switch provides a signal that automatically closes the diverter valve. The suit circuit relief valve prevents overpressurization of the PGA. When PGA pressure is 4.4 psia or more, the relief valve is fully open; when PGA pressure is less than 4.1 psia, the relief valve is fully closed.

Recirculation and temperature control of the cabin oxygen is provided by the cabin recirculation assembly. The assembly contains two fans that recirculate the oxygen, a cabin heat exchanger that automatically heats or cools the oxygen, a transition duct, and a sump for collection of water during the mission when condensation collects in the cabin heat exchanger. The duct, fans, and sump are mounted on the heat exchanger. Heat is transferred to the cabin oxygen from the heat transport section coolant that flows through the cabin heat exchanger. The temperature of the coolant is controlled in the heat transport section. (Refer to paragraph 3-106.)

3-118. OXYGEN SUPPLY AND CABIN PRESSURE CONTROL SECTION.

The oxygen supply and cabin pressure control section (OSCPCS) provides and regulates the oxygen required by the ARS and supplies oxygen to refill the PLSS. The OSCPCS maintains cabin pressure by supplying oxygen at a rate equal to cabin leakage plus astronaut consumption, permits cabin depressurization and subsequent pressurization by the astronauts, and maintains PGA pressure during depressurized cabin operation. The OSCPCS also provides delay of cabin pressure decay (oxygen loss) resulting from a pressure-shell puncture.

The OSCPCS consists of three oxygen tanks, two small tanks in the ascent stage and a larger one in the descent stage, two oxygen demand regulators (one redundant), check valves, shutoff valves, and interconnecting tubing, mounted on a cast manifold with all the necessary interconnecting gas passages.

At the normal pressurization level, the pressure of the cabin and PGA is maintained at 5 ± 0.2 psia, which permits the astronauts to open their faceplates and remove their gloves. When the cabin is depressurized, the PGA's must be sealed and their pressure reduced to the emergency level (egress mode) of 3.7 ± 0.2 , -0.00 psia.

The oxygen used by the ECS is stored in three gaseous oxygen tanks. The oxygen is sufficient for four cabin depressurizations and six refills of the PLSS primary oxygen storage tanks, in addition to normal astronaut consumption and LEM and PGA leakage. Pure oxygen from the cabin depressurization valve is used for cabin depressurizations that require high oxygen flow rates.

The oxygen tanks feed oxygen to both oxygen demand regulators, each with a manual override and control the delivery of oxygen to the ARS in response to signals from pressure sensors.

The cabin repressurization and emergency oxygen valve delivers oxygen to the cabin for repressurization or to delay cabin pressure if the pressure shell is punctured, in response to signals from the cabin pressure switch. The valve has a manual override.

Overpressurization of the OSCPCS is prevented by the oxygen pressure relief valve. The valve automatically relieves excess pressure by venting oxygen into the cabin. Overpressurization of the cabin is prevented by the cabin pressure relief and dump valves. These valves automatically relieve excess cabin pressure by venting oxygen overboard. The valves can be operated manually, from inside or outside the cabin, to dump cabin pressure overboard.

3-119. HEAT TRANSPORT SECTION.

The heat transport section (HTS) consists of a primary and a secondary closed-loop system. Each system circulates an ethylene glycol-water coolant to control the temperature of the electronic equipment. In addition, the primary system controls the temperature of the oxygen circulated through the cabin and the PGA's.

The primary system consists of two coolant pumps (one redundant), a cabin temperature control valve, coolant regenerative heat exchanger, Freon boiler, coolant water evaporator, coolant accumulator, coolant filter, valves, and interconnecting tubing. The secondary system, used for cooling of critical equipment if the primary system fails, consists of a coolant pump, coolant water evaporator, filter, valves, and interconnecting tubing.

In the primary system, the coolant is circulated by one of the two coolant pumps. Each pump can provide normal flow; only one pump is operated at a time. After leaving the pump, some of the coolant flows through the suit circuit heat exchanger and heat from the oxygen is transferred to the coolant; the remainder of the coolant flows through part of the cold plate section, where it absorbs heat from the electronic equipment. The flow then divides between the regenerative heat exchanger and its bypass, providing the required heat for the cabin heat exchanger from the regenerative heat exchanger.

The flow is divided by the cabin temperature control valve, which is controlled by the cabin heat exchanger glycol-water discharge temperature. The temperature of the coolant leaving the cabin heat exchanger is maintained within a narrow range by the cabin temperature control valve. This temperature range in turn maintains the heat exchanger discharge temperature and the cabin temperature within the required range.

The coolant then passes through another parallel cold plate section, where the coolant removes heat from the electronic equipment and the battery section of the descent stage. After passing through the cold plate section, the coolant flows to the suit circuit regenerative heat exchanger for PGA heating, and is controlled by the suit temperature control valve. Waste heat is removed from the coolant by the water evaporator or sublimator removes heat from the coolant; the products of the sublimation process are discharged overboard. The coolant then flows through the coolant filter, which removes particles that could cause a malfunction, and into the coolant pumps to repeat the cycle.

The coolant accumulator maintains pressure above the coolant vapor pressure in the heat transport section and accommodates volumetric changes of the coolant.

Ground support equipment (GSE) provisions are provided for the primary and secondary systems by two sets of two self-sealing quick-disconnects on the right side of the aft equipment bay bulkhead, inside the thermal skin. Each set of quick-disconnects provides for supply and return of the GSE coolant and is used for coolant filling and draining and ground cooling of the LEM during equipment and system checkout.

The secondary system coolant pump, which only operates during flight when the primary system fails, circulates coolant through the emergency (safe return) equipment: cold plates, water boiler, and filter. The water boiler removes heat from the coolant by evaporation; it is the redundant coolant water evaporator and is in the aft equipment bay.

3-120. WATER MANAGEMENT SECTION.

The water management section (WMS) stores potable water for the metabolic needs of the astronauts, LEM evaporative cooling, and PLSS water tank fills and refills. The WMS controls the distribution of water reclaimed by the suit circuit assembly water separators and the distribution of the stored water. Reclaimed water is used for evaporative cooling in the ECS water evaporators.

The WMS consists of a large, spherical, bladder-type water tank in the descent stage, two identical smaller tanks in the upper portion of the midsection of the ascent stage, water pressure regulators, check valves, shutoff valves, and interconnecting tubing. The water fill connections for all three tanks are on the right side of the aft equipment bay bulkhead.

The water tanks are pressurized before earth launch, to maintain the required pumping pressure in the tanks. The pressurization connections for the tanks in the ascent stage are on the tanks; for the tank in the descent stage, the connection is on a bracket remote from the tank. The water control valves and regulators for stored and redundant or reclaimed water are mounted in a cast manifold in the water control module in the cabin.

The water tank in the descent stage supplies the water required up to lunar launch. After lunar launch, water is obtained from the tanks in the ascent stage. In addition to water from the tanks, water from the ARS water separators is used in the WMS. The self-sealing PLSS water disconnect permits filling and refilling the PLSS water tanks and delivering water for drinking and food preparation.

3-121. COLD PLATE SECTION.

The cold plate section (CPS) provides heat sinks for each piece of electronic equipment that requires active thermal control. The cold plates pass coolant from the HTS and remove heat from the electronic equipment. Structural cold plates are either single or redundant and are used as structural mounts for the electronics equipment they cool. The single cold plates contain only one passage through which the HTS primary system coolant is circulated; they are single-pass heat exchangers. Redundant cold plates contain two independent passages: one for primary system coolant; the other, for secondary system coolant.

The largest single group of cold plates is at the rear of the aft equipment bay. A smaller group is on the aft cabin bulkhead. The remaining cold plates are distributed within the ascent stage near the electronics they cool and the descent stage batteries and electronic control assemblies.

3-122. CREW PROVISIONS.

3-123. EXTRAVEHICULAR MOBILITY UNIT.

The extravehicular mobility unit (EMU) is a multilayered unit that consists of a liquid-cooled garment, a pressure garment assembly, a thermal meteoroid garment, a portable life support system, an emergency oxygen subsystem, biomedical and environmental sensors, and dosimeters. To accomplish a safe, manned mission, the EMU is constructed as an anthropomorphic, closed-circuit, pressure vessel that envelops the entire astronaut. With the portable life support system attached to the pressure garment assembly, the astronaut has a livable envelope that can sustain his activities in the LEM or in the lunar environment. Inside the EMU, the astronaut is supplied 100% oxygen. The normal operating pressure of the EMU is 3.7 psia; it weighs approximately 120 pounds.

3-124. Liquid-Cooled Garment. The liquid-cooled garment (LCG), the innermost component of the EMU, is worn by each astronaut during all LEM operations. It retains perspiration residue and maintains body temperature at a comfortable level while the astronauts are in the LEM. On the lunar surface, the LCG prevents perspiration and absorbs body heat.

3-125. Pressure Garment Assembly. The pressure garment assembly (PGA) includes a torso and limb suit, a helmet, and a pair of intervehicular gloves. The PGA is worn during all LEM operations. The PGA is the basic item of the life-support system. It aids in shielding the astronauts from the thermal-vacuum environments of outer space and, if the thermal meteoroid garment is worn, enables them to leave the LEM in free space to perform various functions. The PGA also provides emergency backup protection if cabin pressure is lost. The materials of which the PGA is made resist the abrasive and radiation environments of free space and the lunar surface and minimize the possibility of damage to the PGA during astronaut ingress and egress via the forward or upper entrance hatches.

PGA construction is dictated by mission objectives and the design features of the LEM. The PGA permits the astronaut to enter and leave unaided through either hatch during the mission. Manipulation of the feet, hands, legs, forearms, arms, head, and torso is possible. The astronauts are able to walk, climb, crouch, and rise from a supine to a standing position. The use of tools and LEM controls, voice and telemetry communications, and sightings (inside and outside the LEM) are included in the EMU's performance capabilities.

3-126. Torso and Limb Suit. The torso and limb suit is an anthropomorphic pressure vessel that covers the body and limbs, except the head and hands; intervehicular boots are part of the suit. A

helmet and a pair of intervehicular gloves can be attached to the suit to complete the astronaut's enclosure within the normal 3.7-psia atmosphere. The intervehicular boots provide thermal insulation protection; the bottom of the boots is covered with Velcro-hook material, which, in conjunction with the Velcro-plate material on the cabin floor, provides additional restraint for the astronauts. Assembled to the torso and limb suit, the boots become part of the closed-circuit pressurized envelope provided by the PGA.

3-127. Helmet. The primary function of the helmet is to protect the head against high-impact loads and to provide a life support environment. Separate glare visors are attached to the exterior of the helmet, permitting the astronaut to read vehicle and space data under a wide range of illumination. A microphone and earphones are in the helmet. Helmet construction is compatible with physiological needs and permits eating and drinking.

3-128. Intervehicular Gloves. The intervehicular gloves provide adequate finger dexterity in all pressurized environments. A wrist seal in the sleeves of the torso and limb suit permits replacing damaged gloves with extravehicular gloves while the suit is pressurized.

3-129. Thermal Meteoroid Garment. The thermal meteoroid garment (TMG) includes a thermal meteoroid suit, extravehicular gloves and thermal mittens, and extravehicular boots. These items do not become part of the pressurized envelope provided by the PGA; they are worn over the PGA. The main function of the TMG is to insulate and protect against harmful thermal radiation and protect against micrometeoroids.

3-130. Thermal Meteoroid Suit. The thermal meteoroid suit provides thermal insulation against the lunar-surface environment. It is worn over the PGA, but does not cover the helmet or gloves. It is a loose-fitting, two-piece, multilayered, pajama suit with an aluminized outer coating that renders the suit reflective. The astronaut can don the suit, unaided, in the LEM.

3-131. Extravehicular Gloves and Thermal Mittens. Each astronaut has a pair of extravehicular gloves. A lanyard permits the gloves to be attached to, or removed from, the PGA sleeves. The extravehicular gloves provide insulation protection and are worn during the lunar stay. The wrist seal in the torso and limb suit permits emergency replacement of the intervehicular gloves with the extravehicular gloves while the suit is pressurized. Wearing the extravehicular gloves does not hinder the astronauts in performing emergency and maintenance tasks or in manipulating and erecting mission task equipment. Each astronaut also has a pair of mittens that are worn over the extravehicular gloves. The mittens can be removed for short intervals for added dexterity.

3-132. Extravehicular Boots. Each astronaut has a pair of extravehicular boots for use on lunar surface. These boots are worn over the intervehicular boots to provide additional insulation. The extravehicular boots, like the thermal suit, have a reflective outer coating. The astronaut can don the boots, unaided, in the LEM before descending to the lunar surface.

3-133. Portable Life Support System. (See figure 3-27.) The portable life support system (PLSS) is a self-contained, rechargeable system that provides limited-time life support for an astronaut exposed to extravehicular free space, a decompressed LEM, or the lunar-surface environment. The PLSS consists of subsystems components that provide primary oxygen supply storage; control of contamination, humidity, pressure, ventilation or recirculation, temperature, and electrical power; voice communications facilities; and telemetry transmission facilities.

3-134. Primary Oxygen Supply Storage. Each PLSS includes a pressurized oxygen reservoir that supplies pure oxygen to satisfy body needs for normal and emergency situation. Each reservoir filling provides a maximum supply of approximately 4 hours of oxygen. A 3-hour supply of oxygen is used for completing the mission, with a 1-hour supply of oxygen for contingency. The disconnect fittings used to charge the PLSS reservoir are common-usage CSM-LEM components.

3-135. Contamination. Contamination control includes removal of explosive, noxious, nauseous, or toxic gases, and solid particles and excessive moisture from the recirculation system of the pressurized EMU.

3-136. Humidity. A relative humidity of 40°C to 70°C within +66° to +70° F is maintained in the controlled normal environment of the pressurized EMU.

3-137. Pressure. Primary oxygen maintains a steady 3.7-psia operating pressure within the EMU.

3-138. Ventilation or Recirculation. The ventilation or recirculation system conditions and recirculates the oxygen in the pressurized PGA for cooling.

3-139. Temperature. A temperature range of +66° to +70° F is maintained when the PGA is pressurized.

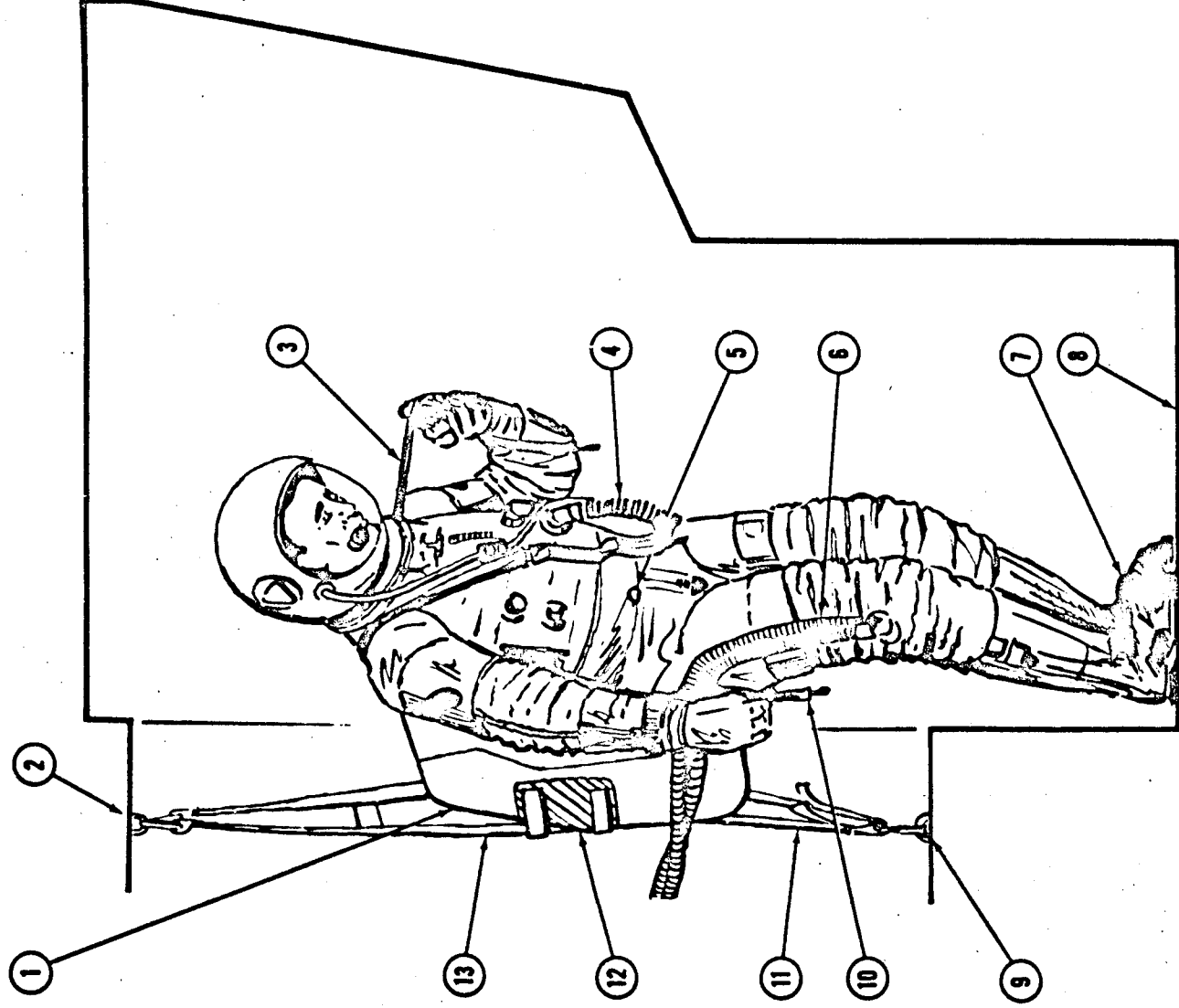

1. PORTABLE LIFE SUPPORT SYSTEM (PLSS)
2. LEM PLSS UPPER ANCHOR POINTS (2)
3. PLSS SHOULDER STRAPS
4. PLSS O₂ LINE
5. PLSS SHOULDER STRAP ANCHOR POINTS
6. LEM ENVIRONMENTAL CONTROL SYSTEM (ECS)
7. VELCRO-HOOK ON BOOTS
8. VELCRO-PILE ON CABIN FLOOR
9. LEM PLSS LOWER ANCHOR POINTS (2)
10. PLSS WAIST STRAP
11. HOOK STRAPS
12. VELCRO-PILE ON PLSS
13. PLSS STRAPS ANCHORED TO LEM

Figure 3-27. PLSS Donning Station

- 3-140. Electrical Power.** Electrical power is supplied by a PLSS battery to all EMU equipment for approximately 4 hours outside the LEM.
- 3-141. Voice Communications.** A duplex subsystem provides simultaneous two-way communication between the astronaut on the lunar surface and the LEM, between two extravehicular astronauts in EMU's, or between the astronaut on the lunar surface and the CSM transmitter and receiver. The communication system microphone and earphones are in the PGA helmet. The antenna for the system is on the helmet. A simplex subsystem in the PLSS provides emergency voice communications and contains its own battery.
- 3-142. Telemetry Transmission.** A telemetry subsystem transmits environmental and biomedical data to the Deep Space Instrumentation Facilities (DSIF), using the LEM subsystem as a relay link. Telemetry information is transmitted only on duplex.
- 3-143. Emergency Oxygen Subsystem.** The emergency oxygen section is actuated by an arming device and a pull cable control of the "green apple" type.
- 3-144. Biomedical and Environmental Sensors.**
- 3-145. Biomedical Sensors.** The EMU's biomedical sensors gather physiological data for telemetry. A government-furnished impedance pneumograph records respiration and cardiac impulses. Body temperature is also obtained for telemetering.
- 3-146. Environmental Sensors.** The astronauts monitor some of the EMU environmental sensors; other data are telemetered for earth monitoring. Data obtained with these sensors include PGA inlet temperature and pressure, oxygen quantity, cumulative radiation dose, and elapsed time. An audible-warning system informs the astronaut of low suit pressure and of high oxygen flow.
- 3-147. Dosimeters.** The dosimeters indicate the amount of exposure to radiation. Serious, perhaps critical, damage results if radiation doses exceed a predetermined level. For quick and easy reference, the astronaut has a dosimeter mounted to his EMU.
- 3-148. WASTE MANAGEMENT.**
- PGA waste management devices include provisions for temporary storage and subsequent removal of urine. The LEM waste management section (WMS) uses the controlled pressure differential between the PGA and the cabin as the force to transfer waste fluid from the PGA waste management devices to the LEM waste fluid collector assembly. Operation of the WMS is started and stopped with the waste control valve. The waste control valve also protects the astronaut from excessive negative pressure differentials. One operational cycle includes evacuation, transfer, and stowage of the waste fluids. The WMS can transfer and evacuate waste fluid from the PGA under the effects of zero-gravity spaceflight and of 1/6-gravity lunar-surface conditions. The waste fluid collector assembly can be removed at intervals and replaced with an unused collector assembly.
- 3-149. FOOD.**
- Prepared food suitable for eating in space environments is supplied to the astronauts. The menus include liquid and solid foods of adequate nutritional and caloric value, with low residue-producing characteristics to minimize biological wastes. Reconstituted food can only be consumed with the helmet removed.
- To prevent spoilage and conserve space, dehydrated food is sealed in pliable plastic packages. To reconstitute the food, the water umbilical hose is attached to the inlet end of the water dispenser (water gun); the outlet end of the water dispenser is inserted into the neck of the food package. Squeezing the trigger of the water dispenser regulates the flow of water into the food package. The astronaut then kneads the food and water until they are thoroughly mixed. Squeezing the bag forces food into the mouth. The water dispenser is also used for drinking potable water.
- Reconstituted food will not be eaten in a pressurized PGA. Special puree-type food in tubes is provided for emergency eating.
- 3-150. SUPPORT AND RESTRAINT EQUIPMENT.**
- Support and restraint equipment (figure 3-28) is provided at the crew stations in the forward cabin section. During flight operations, the constant force reel assembly provides the astronauts with a zero-g tiedown force of approximately 25 pounds, in combination with the Velcro-hook (intervehicular) boots and the Velcro-pile material on the cabin floor.

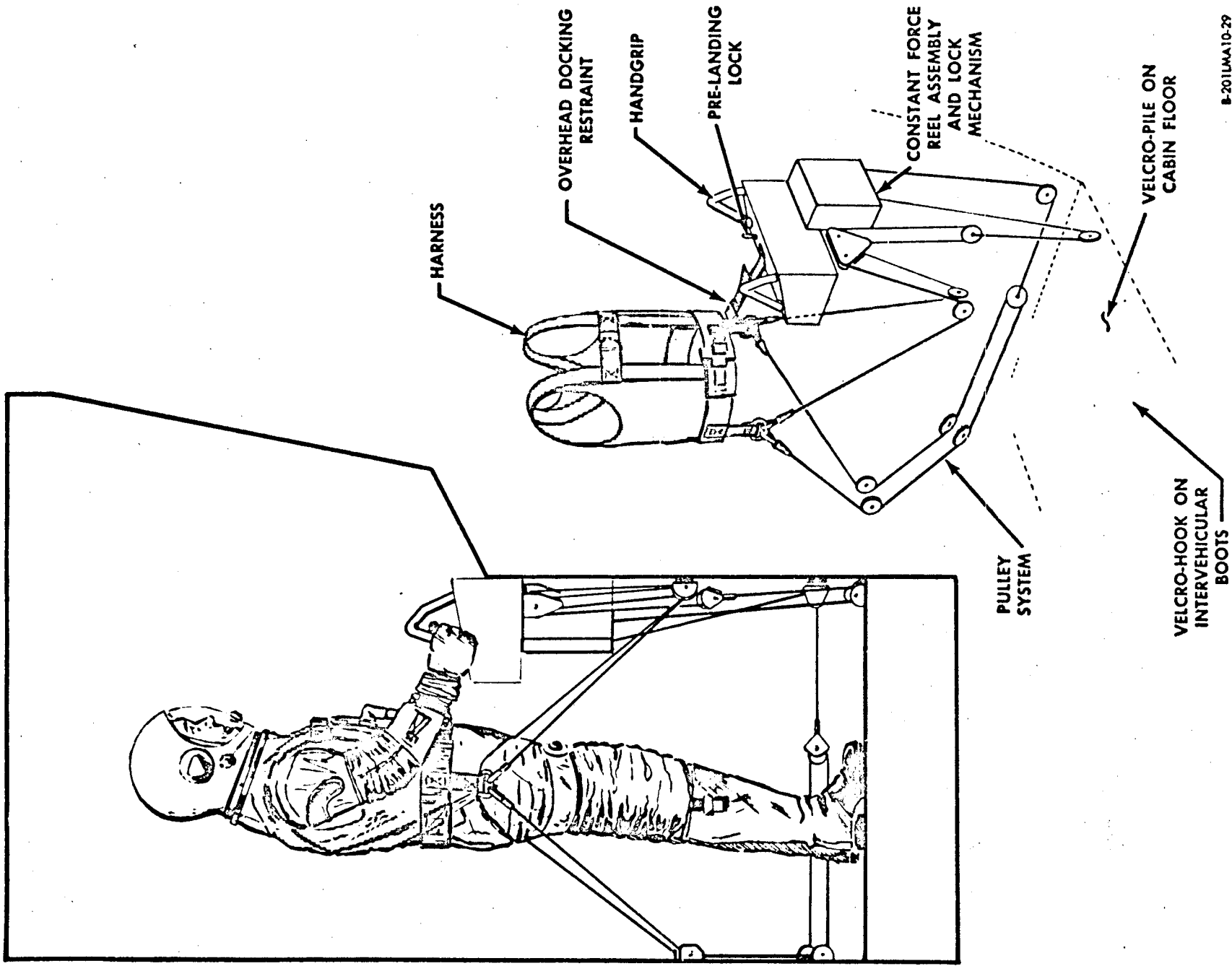

B-201LMA10-29

Figure 3-28. Zero-G Restraint

The support and restraint equipment includes a handgrip and two elongated, U-shaped, shock-attenuating armrest assemblies for each astronaut. When leaning on these armrests, the astronauts have sufficient freedom of motion for operation of the LEM controls and (after the reel is manually locked) protection against negative g's.

3-151. MEDICINE AND STORAGE.

Medical supplies (GFE) planned for the mission consist of six capsules. Four capsules are Darvon (pain killers); two are Dexadrine (pep pills). The package of capsules is to be attached with Velcro-pile to the interior of the food compartment, readily accessible when the compartment is opened.

3-152. ELECTROEXPLOSIVE DEVICES SUBSYSTEM. (See figure 3-29 and 3-30.)

The LEM Electroexplosive Devices Subsystem (EED), also referred to as the Explosive Devices Subsystem (ED), is used to initiate functions which are accomplished explosively. Apollo standard initiators are used as the triggers. Some of these functions are helium pressurization of the Ascent and Descent Propulsion Subsystems and the RCS, landing gear deployment, and separation of the LEM ascent stage and descent stages.

The EED consists of two batteries, an EED control panel, two EED fuse and relay boxes, two EED pyro power busses, and the explosive charges and devices. Power to actuate squib relays in the ED relay box is drawn from the main power supply; power for ED initiator ignition is supplied by the ED batteries.

Each ED battery supplies power to an identical redundant bus for the initiation of all explosive devices on the LEM, controlled by its switch on the EXPLOSIVE DEVICES PANEL (figure 3-2).

Each ED power switch operates two power relays. These relays provide a continuous circuit between each ED battery and its respective ED power bus. Each function switch (STAGE, RCS PRESS, LDG GEAR DEPLOY, DES PRESS and ASC PRESS) actuates two relays, one in each ED relay box. Each relay provides a circuit between its respective ED power bus and its associated explosive device. Each staging relay, when actuated, provides a circuit, between an ED power bus and a redundant set of staging function relays (for the descent deadface, cable cutters, ascent deadface, bolts and nuts). Two separate explosive devices (one redundant) are provided at each function, each device drawing power for initiation from a separate ED power bus. This provides, with the duplicate relays and parallel paths to the ED power busses, complete redundancy for the ED subsystem.

Each function switch, except for the STAGE switch, has a lever-locking SAFE position and a momentary FIRE position. The STAGE switch has lever-locking in the ON and OFF positions. The ASCENT HE SEL switch has lever locking TANK 1, BOTH and TANK 2 positions.

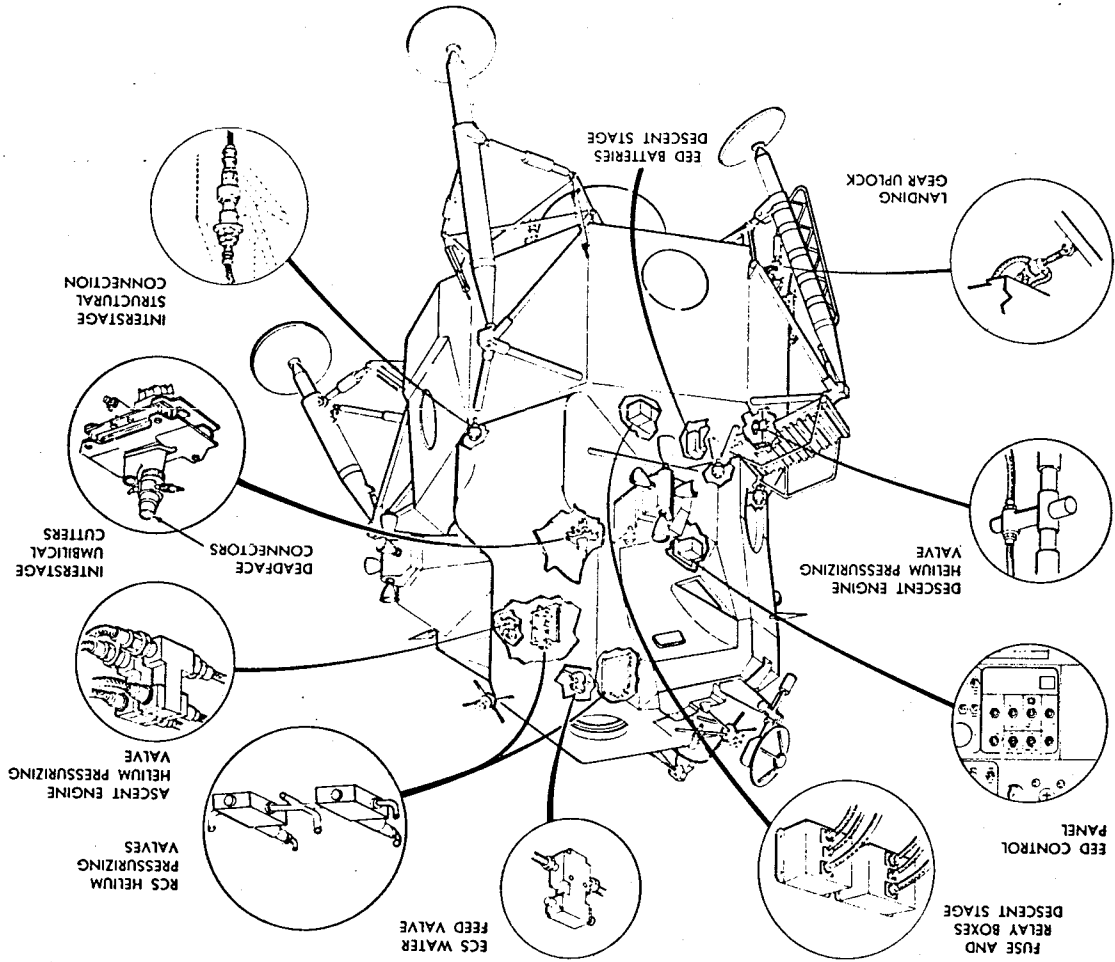

Figure 3-29. Explosive Devices Location

15 October 1963

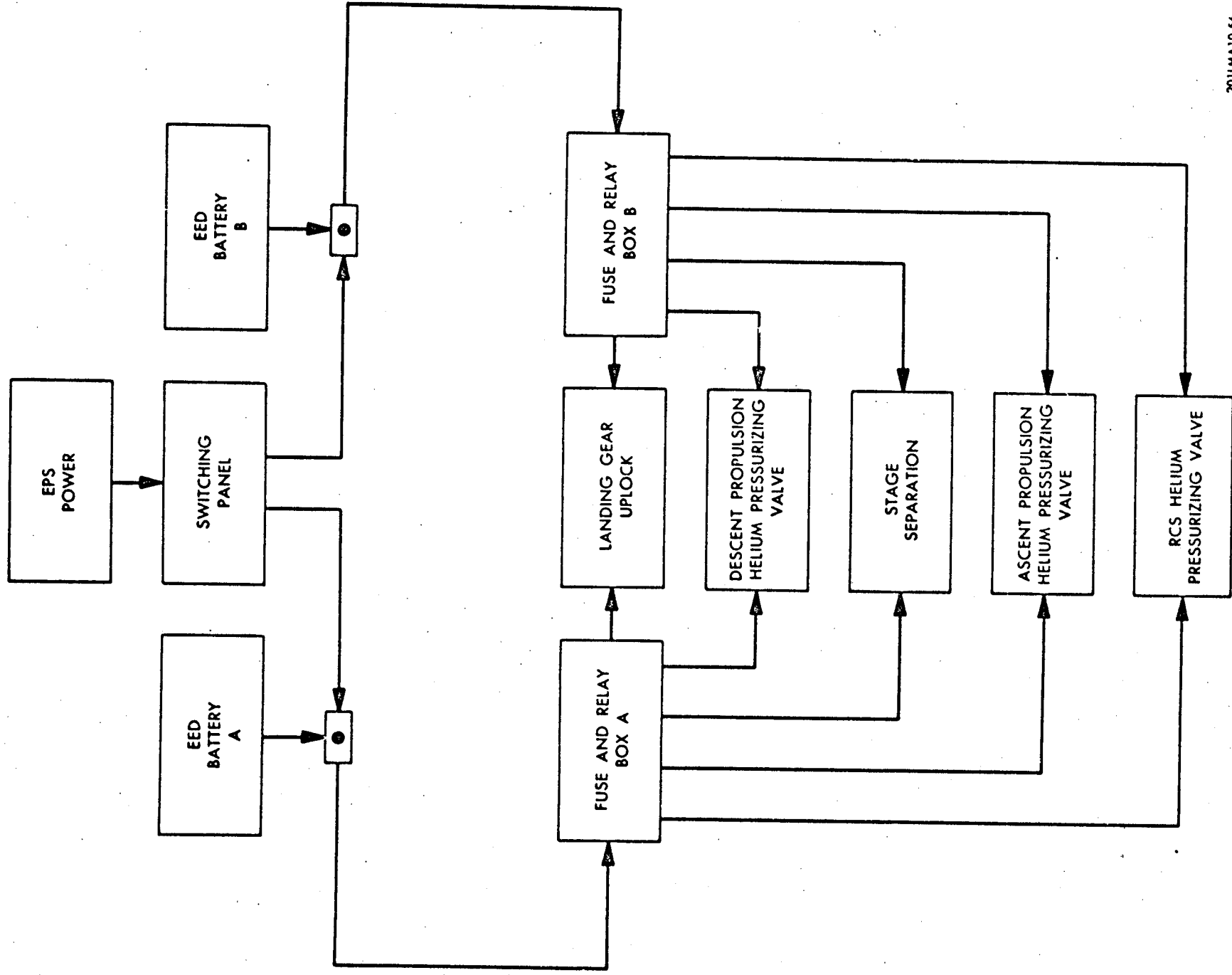

Figure 3-30. Explosive Devices Block Diagram

SECTION IV

PRELAUNCH OPERATIONS

4-1. GENERAL

This section covers the prelaunch operations and facilities used for the LEM at the Kennedy Space Center (KSC). The primary purpose of these operations is to verify the functioning of each subsystem in all operational modes without removing the equipment from the LEM.

4-2. PRELAUNCH TESTS AND OPERATIONS.

Functional and verification tests will be performed on the complete LEM system using fluid, mechanical and electrical ground support equipment. These tests are mainly automatically controlled by the Acceptance Checkout Equipment - Spacecraft (ACE-S/C).

Prelaunch verification tests will be performed in sequence at the Hypergolic Test Building, the Radio Frequency Systems Test Facility, the Manned Spacecraft Operations Building, and the Vehicle Assembly Building Final Checkout, before countdown will be performed on the launch pad (see figure 4-1).

4-3. ACCEPTANCE CHECKOUT EQUIPMENT - SPACECRAFT.

The Acceptance Checkout Equipment - Spacecraft (ACE-S/C) is a general-purpose spacecraft checkout system for automatic, semiautomatic, or manually controlled prelaunch testing of the LEM system. Its capabilities include generation of test commands and stimuli, monitoring spacecraft subsystem performance, conversion and processing of data, measurement of subsystem responses to test stimuli, diagnostic testing, and enabling communication between the LEM and personnel at ACE-S/C controls. The ACE-S/C consists of an ACE-S/C Ground Station, ACE-S/C Carry-On Equipment, and ACE-S/C Peripheral Equipment.

The ACE-S/C Ground Station is adapted to specific LEM subsystems by the ACE-S/C Carry-On Equipment, and to the LEM servicing equipment by the ACE-S/C Peripheral Equipment. The ACE-S/C Carry-On Equipment comprises an Up-Link and a Down-Link. The Up-Link receives, decodes, conditions, and converts digital test commands from the ACE-S/C Ground Station and routes them to the proper input points of the subsystems undergoing test. The Down-Link monitors the performance of the LEM subsystems, and conditions, codes, and multiplexes this data for transfer to the ACE-S/C Ground Station. The ACE-S/C Peripheral Equipment performs the same general functions for the LEM ground support equipment that the ACE-S/C Carry-On equipment performs for the LEM subsystems. The ACE-S/C Carry-On Equipment and Peripheral Equipment are described in greater detail in Section V.

The ACE-S/C Ground Station, Carry-On Equipment, Peripheral Equipment, and associated LEM ground support equipment completely test the LEM system, including testing across subsystem interfaces; completely test independent subsystems; provide any desired degree of test automation; process large quantities of data for real-time display; adapt to system or test-mode changes by easily accomplished program changes; perform diagnostic testing if a malfunction is detected; and perform self-check functions. The ACE-S/C Ground Station equipment is in three primary areas: the control room, the computer room, and the terminal facility room.

The control room, which contains the data display subsystem and part of the command-generation subsystem, contains the test conductor console and control consoles for the following LEM subsystems and sections: Instrumentation, Communications, Environmental Control, Electrical Power, primary guidance and navigation, stabilization and control, and Propulsion and Reaction Control. Cathode-ray tubes that display real-time data from the computer room in alpha-numeric form are the primary display devices. These are supplemented by analog and digital displays. A summary of the complete LEM test is displayed to the test conductor at his console in the control room; detailed subsystem tests are displayed in the manual mode, engineers manually select individual, programmed, test commands. In the semi-automatic mode, programmed subroutines that contain one or more test commands are also selected manually. In the automatic-with-manual-override mode, test commands are generated under program control, in synchronization with a real-time clock.

The computer room contains the data acquisition subsystem, the computer subsystem, and data-transmission equipment. The data acquisition subsystem prepares spacecraft checkout data for recording, display, and for transfer to the computing subsystem. The computing subsystem consists of a data-processing computer, a digital command computer, and a common memory. The data-processing computer compares spacecraft checkout data from the data acquisition subsystem with programmed tolerances and conditions it for CRT display. If an out-of-tolerance condition is detected, an appropriate indication is provided to the test engineer at the malfunctioning subsystems test console in the control room. Diagnostic action can be initiated at the test engineer's discretion. All spacecraft test commands, generated in a parallel format by the digital command computer, are converted to a serial format for transmission to the spacecraft.

The terminal facility room contains part of the command generation subsystem, part of the data display subsystem, timing equipment, and the terminal patch facility. The terminal patch facility transmits test data to and from the LEM and the associated ground support equipment via coaxial hardlines and repeater-amplifiers.

4-4. PRELAUNCH CHECKOUT.

The primary goal of the prelaunch checkout at KSC is to ascertain, on the ground, that the LEM can achieve its intended mission. To ensure that this goal is reached, prelaunch verification tests at the Eastern Test Range (ETR) are performed (figure 4-1). A brief discussion of the LEM checkout operations at each facility is presented in the following paragraphs.

4-5. HYPERGOLIC TEST BUILDING.

A receiving inspection of the ascent stage will be performed in the West Cell of the Hypergolic Test Building (HTB). Checkout and servicing of the heat transport section of the Environmental Control Subsystem (ECS) will be performed to provide cooling capability during subsequent checkout tests. Leak and functional checks will be performed on the ascent propulsion system, Reaction Control Subsystem, (RCS), oxygen supply and cabin pressure control section (OCPS), and water management section. The ascent stage will then be transported to the Radio Frequency Systems Test Facility (RFSTF).

A receiving inspection of the descent stage will be performed in the East Cell of the HTB. The OCPS will be checked for leakage, and leak and functional checks will be performed on the descent propulsion and supercritical helium storage subsystems, using both ambient and supercritical helium in the storage subsystem. The descent stage will then be transported to the RFSTF.

4-6. RADIO FREQUENCY SYSTEMS TEST FACILITY.

The ascent stage will be mounted on the three-axis positioner, and the abort sensor assembly (ASA) will be installed. Guidance and navigation coefficient determination and rendezvous radar pointing accuracy and tracking tests will be performed. The S-band steerable antenna will be tested, using an rf source and motion inputs to the positioner. An ags dynamics check and an rf interference test will be performed. The ascent stage will then be transported to the Manned Spacecraft Operations Building (MSOB).

The nonflight landing gear will be installed on the descent stage, and the stage will then be mounted on the three-axis positioner. The landing radar antenna will be optically aligned and the landing radar boresight test will be performed. The nonflight landing gear will then be removed, and the descent stage will be transported to the MSOB.

4-7. MANNED SPACECRAFT OPERATIONS BUILDING.

An ascent stage-to-command module docking test will be performed before preparing the ascent stage for mating to the descent stage.

A check of the descent stage-to-spacecraft LEM adapted (SLA) fit will be performed, and the heat transport water management sections of the ECS will be checked for leakage, before preparing the descent stage for mating to the ascent stage.

The ascent and descent stages will be mated. Checks of electrical circuitry, and Guidance Navigation and Control (GN & C) Subsystem functional tests, will be performed. The alignment optical telescope (AOT) will be calibrated and the rendezvous radar antenna, S-band antenna, and GN & C subsystem will be checked for alignment. Functional tests will be performed on the landing radar, the rendezvous radar, and the communications subsystem. An integrated flight controls test and mission simulation will also be performed. The voice-conference capability of the communications subsystem will be verified.

HYPERGOLIC TESTS

Receiving In
Cabin Service
HTS Leak C
HTS Primar
OCPS Leak C
WMS Leak C
GSE Connect
EPS & Instr
Latching Fur
Propellant F
Relief Valve
Engine Leak
Primary Ch
He Regulation
Redundant C
Gasous He
RCS Propell
RCS Quad C
He Relief Va
RCS He Reg
RCS TCA &
RCS Propell
RCS He Pre
RCS Isolatio
RCS & Engin
RCS Propell
Cabin Service
Transport A

HYPERGOLIC TESTS

Receiving In
GSE Connect
OCPS Leak C
SHe Tank &
SHe Tank In
SHe Relief V
Propellant F
Relief Valve
Engine Leak
Primary Ch
He Regulation
Redundant C
Gasous He
Access Pane
Transport D

BUILDING - ASCENT STAGE

Remove Access Panel Removal
Check & Servicing
Leak Functional Check & Servicing (Coolant Support)
Leak Check
Leak & Verification
Leak Verification Turn-On and Verification
Leak Check
Leak System Exterior & Interior Leak Check
Leak Functional Check
Leak Functional Checks
Leak Valve Leak & Functional Checks
Leak He S O Valves Leak & Functional Checks
Leak Valve Functional Check
Leak Cold Flow Test
Leak Bladders & Disconnect Low Pressure Check
Leak Valves & Burst Disc Leak & Functional Checks
Leak Leak & Functional Checks
Leak He S O Valves Leak & Functional Checks
Leak Inifold Leak Checks
Leak Feed Section Gaseous N2 Cold Flow Test
Leak Initialization Section Leak Check
Leak Valve & Mandrel Leak Checks
Leak He Tank Loading & Leak Check
Leak Gasline Section Verification
Leak Access Panel Installation
Leak End Stage to RFTF

RADIO FREQUENCY SYSTEMS TEST FACILITY - ASCENT STAGE

Mount On Three-Axis Positioner
Cabin Servicing
GSE Power & Coolant Connection & Verification
EPS & Instrumentation Turn-On & Verification
ASA Installation
Communications Tests
G & N Turn-On, Scale Factor & IRIG Coefficient Determination
EMC Tests
Rendezvous Radar Pointing Accuracy & Tracking Tests
S & C Turn-On & AGS Dynamic Check
Cabin Servicing
Transport Ascent Stage to MSOB

BUILDING - DESCENT STAGE

Remove Access Panel Removal
Leak & Verification
Leak Components Ambient Leak Check
Leak Fill
Leak Section Integrity (Heat Leak) Check
Leak Functional Check
Leak System Exterior & Interior Leak Check
Leak Functional Checks
Leak Valve Leak & Functional Checks
Leak He S O Valves Leak & Functional Checks
Leak Valve Functional Check
Leak Cold Flow Test
Leak Installation
Leak End Stage to RFTF

RADIO FREQUENCY SYSTEMS TEST FACILITY - DESCENT STAGE

Install Non-Flight Landing Gear
Mount On Three-Axis Positioner
GSE Connection & Verification
Landing Radar Tests
Remove From Three-Axis Positioner
Remove Non-Flight Landing Gear
Transport Descent Stage to MSOB

I. POLARITY FIXTURE

Cabin Servicing
 HTS Primary & Redundant Loop Leak Check
 HTS Primary Loop Servicing, Evacuate & Backfill
 GSE Power & Coolant Connection & Verification
 EPS & Instrumentation Turn-On & Verification
 Instrumentation Tests
 EPS Switchover & Mode Select Test
 Pyrotechnics Circuitry Resistance & Isolation Test
 Pyrotechnics Circuit Functional Test
 G & N Turn-On, Functional Test, PTC Temperature Cur
 G & N Check-out, Scale Factor & IRIG Coefficient Detern
 LGC Clock Test
 Stabilization Loop Response Test
 LGC ROPE, Module Verification
 LGC Margin Test
 LEM Alignment
 Rendezvous Radar Antenna G & N Alignment Check
 G & N Fine Alignment
 AOT Calibration Test
 S & C Turn-On, ACS Functional Checkout, & Jet Logic
 Rendezvous Radar & Landing Radar Turn-On & RF Chec
 Rendezvous Radar Antenna Coverage Test
 Rendezvous Radar Surface & Skin Modes Tracking Test
 Communications System Functional Evaluation
 Polarity Checks
 FCS Checkout
 Mission Simulation
 Cabin Servicing
 Install LEM in Altitude Chamber

II. ALTITUDE CHAMBER

A. Sea Level Tests

Cabin Servicing
 GSE Power & Coolant Connection & Verification
 EPS & Instrumentation Turn-On & Verification
 WMS Leak Check & Servicing
 OPCS Leak Check & Servicing
 Lighting Check - Exterior & Interior
 Crew Support Restraints Check
 Waste Management Section Leak & Functional Checks
 HTS Redundant Loop Servicing, Evacuate & Backfill
 HTS Functional Check
 OPCS Servicing & Functional Check
 WMS Functional Check
 ARS WMS Leak Check
 Cabin & Test Hatch Leak Check
 Flight Hatch Fit Check
 OPCS Servicing, Evacuate & Backfill
 WMS Servicing, Evacuate & Backfill
 ARS Servicing
 Cabin Servicing

B. Unmanned Tests

Chamber Evacuation
 ECS Functional Checks
 Chamber Repressurization
 Cabin Servicing
 ARS Servicing
 HTS Servicing
 OPCS Servicing
 WMS Servicing
 Cabin Servicing

C. Manned Tests

Chamber Evacuation
 ECS & Crew Provisions Test
 Chamber Repressurization
 Cabin Servicing
 Post-Servicing
 Cabin Servicing
 Transport LEM to Landing Gear Installation Fixture

III. LANDING GEAR INSTALLATION FIXTURE

Landing Gear Installation & Functional Test
 Pyrotechnics Mechanical Installation
 Thermal Shield Installation & Exterior Refurbishment
 Transport LEM to SLA Stand

IV. SLA STAND

Mating, LEM-to-CSM SLA
 Install Platforms & ACE Carry-On Equipment
 Transport Spacecraft to VAB

MANNED SPACECRAFT OPERATIONS BUILDING - ASCENT STAGE

Docking Test: Ascent Stage-to-CM
 Installation Ascent Stage On Polarity Fixture
 Mating: Ascent Stage-to-Descent Stage

MANNED SPACECRAFT OPERATIONS BUILDING - DESCENT STAGE

Fit Check: Descent Stage-to SLA
 Install Descent Stage On Polarity Fixture
 HTS Leak Check
 WMS Leak Check
 Mating: Descent Stage-to-Ascent Stage

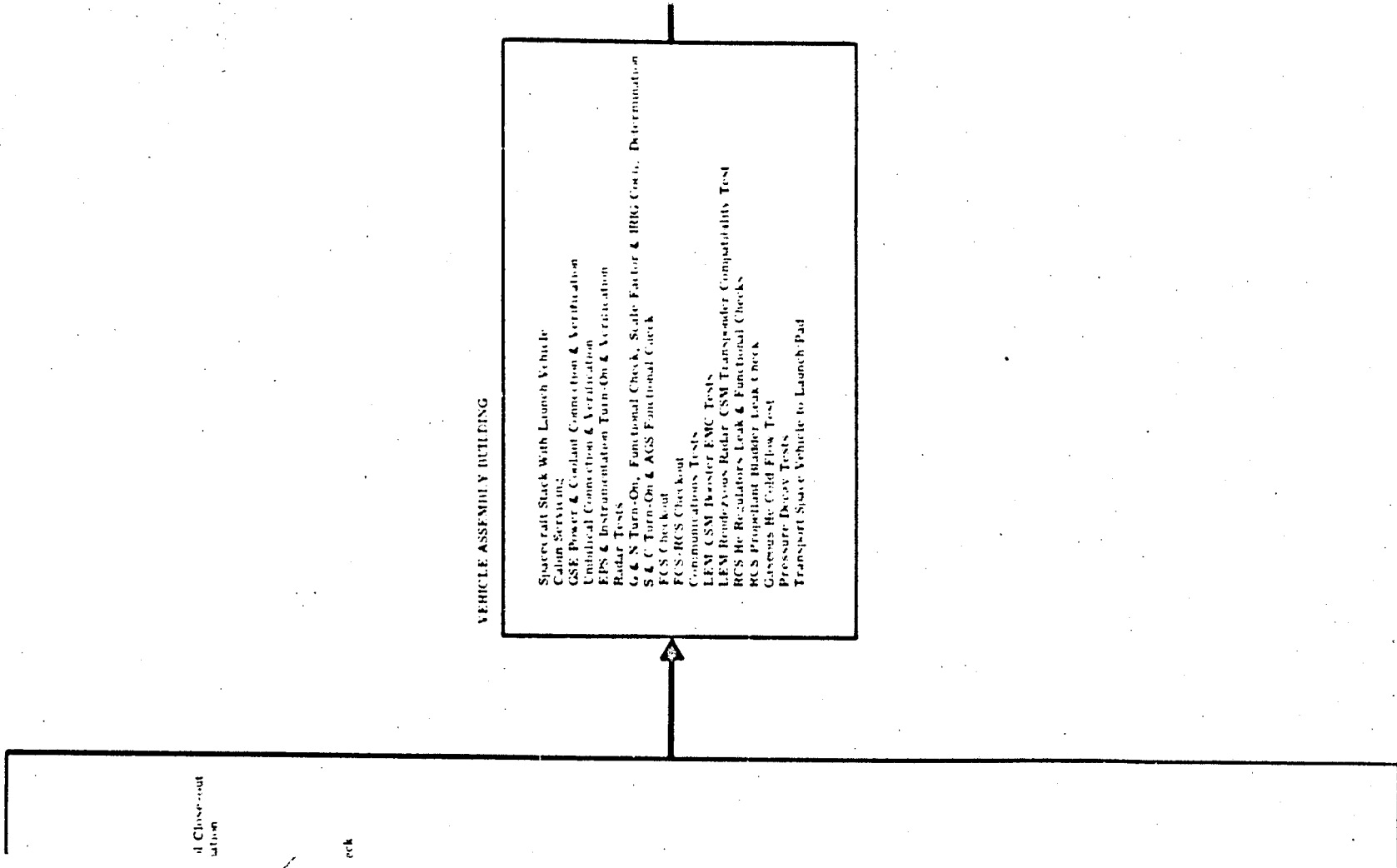

Figur

LAUNCH PAD

- I. FINAL CHECKOUT
- LEM IRII Checks
 - Mobile Service Structure Moved in Place
 - Cabin Servicing
 - GSE Power & Coolant Connection & Verification
 - EPS & Instrumentation Turn-On & Verification
 - S & C Turn-On & A/GS Functional Check
 - G & N Turn-On, Functional Check, Scale Factor & IRIIG Code² Data² Collection
 - G & N Tests
 - Radar Tests
 - LEM Rendezvous Radar CSM Transponder Compatibility Test
 - Communications Tests
 - FCS Test
 - Pressure Decay Tests
 - Pyrotechnics Functional Check
- II. COUNTDOWN DEMONSTRATION
- Water Loading
 - Countdown Demonstration
 - ECS Functional Check
- III. COUNTDOWN
- RCS Propellant Gaging Section Verification & Hyperbolic Loading
 - GSE Power & Coolant Connection & Verification
 - EPS & Instrumentation Turn-On & Verification
 - Radar Tests
 - S & C Tests
 - FCS Checkout
 - G & N IRIIG Coefficient & Scale Factor Determination
 - Communications Tests
 - EPS Flight Battery Installation
 - EPS Switchover & Internal Power Checkout
 - ACE Carry-On Equipment Removal
 - Air Equipment Bay Close-out
 - Pyrotechnics Initiator Installation
 - Pyrotechnics Battery Installation
 - Cabin Lighting Check
 - Liquid He Loading
 - Gaseous He Loading
 - Gaseous Oxygen Loading
 - Cabin Close-out
 - Install LEM Forward Hatch & Remove GSE Tunnel
 - Cabin Purge & ABS Purge
 - SLA Platform Removals & SLA Close-out
 - Move Mobile Service Structure to Launch Position
 - Switchover From Ground Power to Flight Battery Power

The LEM will then be installed in the altitude chamber and all ECS sea-level leak and functional checks will be performed. The FCS will then be serviced in preparation for unmanned LEM altitude testing, which will demonstrate the structural integrity of the LEM and the capability of the ECS to support manned altitude tests. Manned altitude tests will then be performed to demonstrate ECS and crew-provisions capabilities with a man in the system. The LEM will then be transported to the landing gear fixture, where the flight landing gear will be installed and checked. Explosive devices will then be installed, and installation of the thermal shield will be completed. The LEM will then be mated to the CSM/SLA, and transported to the Vehicle Assembly Building (VAB).

4-8. VEHICLE ASSEMBLY BUILDING.

The LEM, mated to the CSM/SLA, will be stacked on the launch vehicle; spacecraft-to-launch vehicle and GSE interfaces will be verified; all LEM subsystems will be checked; and two overall tests will be performed. The fully assembled Apollo Space Vehicle will then be transported (in the vertical position on a tractor-crawler) to the launch pad.

4-9. LAUNCH PAD.

On the launch pad, tests of LEM subsystems will include a LEM-to-launch pad EMI check, RCS and propulsion subsystems pressure-decay tests, GN & C and radar functional tests, and communications verification. A countdown demonstration will be performed to verify that the terminal countdown procedures can be accomplished in the allotted time. After simulated flight test (including LEM subsystems), all hypergolic servicing and supercritical helium servicing will be accomplished, flight batteries will be installed, ECS servicing will be completed, all ACE-S/C Carry-On Equipment will be removed (following a final subsystems checkout) pyrotechnics will be installed, and a) final launch preparations will be made (including closing of the cabin and SLA hatches).

SECTION V
GROUND SUPPORT EQUIPMENT

5-1. GENERAL.

The LEM Ground Support Equipment (GSE) consists of the ACE-S/C Carry-On Equipment and Peripheral Equipment, Spacecraft and Servicing Equipment Control and Checkout Equipment, Servicing Equipment, Condition and Equipment Simulators, Handling and Transportation Equipment and Workstands, and Bench Maintenance Equipment. Common and concurrent usage GSE comprises NAA GSE and items that can be used for checkout, servicing, handling, and auxiliary functions of the LEM and Command/Service modules.

5-2. ACE-S/C CARRY-ON EQUIPMENT AND PERIPHERAL EQUIPMENT.

The ACE-S/C Carry-On Equipment and Peripheral Equipment are spacecraft-associated extensions of the Acceptance Checkout Equipment - Spacecraft (ACE-S/C) Ground Station. The ACE-S/C Carry-On Equipment adapts the ACE-S/C Ground Station to the LEM subsystems and is, for the most part, carried into the LEM when ACE-S/C-controlled prelaunch tests are to be performed. The ACE-S/C Peripheral Equipment adapts the ACE-S/C Ground Station to the LEM ground support equipment and servicing equipment, enabling ACE-S/C control of nonelectronic functions of the LEM and the use of special electronic test circuitry in electronic ground support equipment.

5-3. ACE-S/C CARRY-ON EQUIPMENT.

The ACE-S/C Carry-On Equipment comprises an Up-Link and a Down-Link. The Up-Link receives digital test commands generated by the ACE-S/C Ground Station, decodes them, and applies preprogrammed stimuli to addressed inputs in the LEM subsystems. The Down-Link continuously monitors, samples, conditions, codes, and interleaves LEM subsystem performance data servicing equipment response data, and LEM telemetry data; the resultant serial data train is transmitted to the ACE-S/C Ground Station.

5-4. Up-Link. The Up-Link is a digital test command system (DTCS). The DTCS generates up to 2,048 stimuli (discrete or analog), or 128 single-point differential output analog signals, or various combinations thereof, and routes these stimuli to the proper LEM subsystem input or inputs upon receipt of coded test commands from the ACE-S/C Ground Station. In addition, the DTCS transmits a check-status-reply signal to the ACE-S/C Ground Station whenever test commands are received, automatically providing self-check information for validity analysis and assuring the operators of the accuracy of the checkout data processed by the DTCS. The DTCS used in the LEM comprises a receiver-decoder, guidance and navigation (G & N) computer buffer unit, baseplate unit, conventional relay module, latching relay module, and digital-to-analog converter module.

The receiver-decoder receives ACE-S/C Ground Station test commands at rates up to one million bits per second and routes test commands to a baseplate unit group or to the G & N computer buffer unit.

The G & N computer buffer unit processes, checks, and routes test commands received from the receiver-decoder and addressed to the LEM guidance computer (LGC) of the GN & C Subsystem.

Up to eight baseplate units can be used to form one baseplate unit group; up to four baseplate unit groups can be used simultaneously. All receiver-decoder outputs not intended for the LGC are addressed to one baseplate unit group and to one baseplate unit within that group. The addressed baseplate unit selects one of four modules at its output. The four output modules can be any combination of conventional relay modules, latching relay modules, and digital-to-analog converter modules. The combination of modules used depends upon the type of input required by the LEM subsystem undergoing test.

The conventional relay module controls the application of stimuli to the LEM subsystems upon ACE-S/C Ground Station command applied to it by a baseplate unit.

The latching relay module performs the same function as the conventional relay module. The latching relay module relays change state only upon DTCS command, not upon power application or removal. The

latching relay module is used in situations where loss of power to a conventional relay that controls a critical signal or bias would cause the relay to drop out and thereby damage the subsystem undergoing test.

The digital-to-analog converter module converts its binary input from the baseplate unit into analog signals for application to the LEM subsystems.

Receiver and Baseplate Unit, Part No. 410-92200, comprises one receiver-decoder, one baseplate unit, and four modules (any combination of relay modules and digital-to-analog converter modules). Carry-On Command Unit, Part No. 410-92201, comprises two baseplate units, and eight modules (any combination of relay modules or digital-to-analog converter modules).

5-5. Down-Link. The responses of the LEM subsystems to test stimuli applied by the DTCS are monitored by the Down-Link, which is a digital test measuring system (DTMS). The DTMS receives performance and response data from the LEM subsystems from LEM telemetry, and from the ACE-S/C Peripheral Equipment, part of which monitors the performance of the LEM servicing equipment. The DTMS continuously monitors and codes the response data, arranges them into a telemetry format, and routes them to the ACE-S/C Ground Station for processing and display.

The DTMS performs two major functions: that of a pcm response section and a data-interleaving section. The analog portion of the pcm response section conditions and commutates analog response data and converts the data into analog parameters and into various discrete values, providing parallel, 8-bit binary representations of the commutated test-point outputs. The digital portion of the pcm response section conditions and commutates digital parameters, providing single binary-digit representations of the individual test-point outputs. These single binary digits are then multiplexed with other digital data to form parallel 8-bit words. These words are multiplexed with the outputs of the analog portion of the pcm response section, converted to a serial format, and applied to the data-interleaving section. The data-interleaving section multiplexes these data with data received from LEM telemetry and from the ACE-S/C Peripheral Equipment and transmits the resultant serial data train to the ACE-S/C Ground Station. The pcm response section comprises a digital signal conditioning and multiplexing unit, analog signal conditioning and sampling unit, G & N signal conditioning and switching matrix unit, high sampling rate signal conditioning unit, and a carry-on pcm system.

The Digital Signal Conditioning and Multiplexing Unit, Part No. 410-92211, uses timing signals from the carry-on pcm system to condition and time-multiplex up to 320 event (on-off) signals from the LEM subsystems into an eight-line parallel format for transmission to the carry-on pcm system.

The Analog Signal Conditioning and Sampling Unit, Part No. 410-92212, uses carry-on pcm system timing signals to sample up to 250 analog signals from the LEM subsystems at a rate of 1 sample per second and up to 100 analog signals at a rate of 10 samples per second. These are transferred to the carry-on pcm system in a pulse-amplitude-modulated (pam), non-return-to-zero (nrz) format.

The G & N Signal Conditioning and Switching Matrix Unit, Part No. 410-92213, receives 39 unconditioned analog signals and 11 conditioned analog signals from the LEM GN & C Subsystem. Of the 39 unconditioned analog signals, 32 are routed to this assembly's switching matrix unit, where one of the signals is selected for sampling at a rate of 400 samples per second. All the input signals are applied to this assembly's 50-channel subcommutator, where they are subcommutated into a pam data train and routed to the carry-on pcm system.

The High Sampling Rate Signal Conditioning Unit, Part No. 410-92214, uses timing signals from the carry-on pcm system to accept 50 unconditioned and 20 conditioned signals from the LEM subsystems. Of the 50 unconditioned signals, 20 are conditioned and applied to the carry-on pcm system. The remaining 30 unconditioned signals are conditioned and subcommutated with the 20 conditioned input signals. These are applied to the carry-on pcm system in a pam format.

The Carry-On PCM System, Part No. 410-92210, receives timing signals from the data-interleaving section, and 128 channels of analog data, pam-nrz data, and digital data from the signal conditioning units described previously. The carry-on pcm system supplies timing signals to the previously described signal conditioning units; commutates preconditioned analog data; subcommutates and supercommutates conditioned analog data; converts all analog data into parallel, 8-bit digital words, multiplexes analog words and event words into specific word locations within the required data format; and converts parallel digital data into a serial, pcm-nrz data train for transfer to the data-interleaving section.

The functions of the data-interleaving section are performed by Data Interleaver, Part No. 410-92232. This unit interleaves LEM subsystem performance data from the carry-on pcm system, data supplied by LEM telemetry, and data from the servicing equipment-ACE-S/C adapter, which is part of the

ACE-S/C Peripheral Equipment. Operation of the data interleaver is controlled by command signals from the DTCS and timing signals from LEM telemetry. The interleaved LEM-subsystem, telemetry, and servicing-equipment data are transmitted in a return-to-zero, bi-phase, pcm format to the ACE-S/C Ground Station. The data interleaving system assembly also sends noninterleaved telemetry data to the ACE-S/C Ground Station.

5-6. ACE-S/C PERIPHERAL EQUIPMENT.

The ACE-S/C Peripheral Equipment comprises Servicing Equipment Digital Command System, Part No. 410-92241, and Servicing Equipment-ACE-S/C Adapter, Part No. 410-92240. Generally, the servicing equipment digital command system functions as a DTCS for all servicing equipment and ground support equipment involved in the testing of the LEM with ACE-S/C. It includes a receiver-decoder, baseplate units, conventional relay modules, latching relay modules, and digital-to-analog converter modules, all of which function as described in paragraph 5-4. The servicing equipment-ACE-S/C adapter receiver timing signals from the data interleaver, and up to 1,000 event signals and 200 analog signals from the LEM servicing equipment and ground support equipment. These are multiplexed into a pcm-nrz data train and transferred to the data interleaver.

5-7. EQUIPMENT FOR CONTROL AND CHECKOUT OF SPACECRAFT AND SERVICING EQUIPMENT.

5-8. RENDEZVOUS RADAR/TRANSPONDER ANTENNA HAT, PART NO. 410-11960.

The rendezvous radar transponder antenna hat suppresses rendezvous radar/transponder antenna radiation without substantially altering the voltage-standing-wave-ratio (VSWR) of the antenna. The antenna hat is used in sampling antenna acquisition threshold and acquisition time, r-f transmitter characteristics, and in conducting LEM - CSM compatibility tests. The hat is a metallic shell that fits around the antenna. It contains r-f lossy material to absorb the indicated power at microwave frequencies.

5-9. CIRCUIT ANALYZER TEST SET, PART NO. 410-12920.

The circuit analyzer test set is a rack-mounted, programmed test unit used to automatically check ground support equipment interface wiring. The test set consists basically, of a programmer, voltage supplies, test circuits, and a printout device. It is used to periodically check and calibrate direct and indirect cable runs between connectors at the control center and those at the controlled units and the test vehicles; automatically control more than 100 relays; verify the associated relay response lines; and check transistor circuits driving these relays. The test prints out all indications of circuit failures, out-of-tolerance voltages and resistances, and discontinuities at high potentials.

5-10. RENDEZVOUS RADAR AND LANDING RADAR ELECTRONIC CHECKOUT ADAPTER, PART NO. 410-31010.

The rendezvous radar and landing radar electronic checkout adapter operates in two modes and provides buffer and line driver circuits for GSE test stimuli and measurement data that are routed between the radar test points and the Radar Section Checkout Station (RSCS). The checkout adapter contains two identical servo loops and a number of attenuators, buffer/driver amplifiers, and switches, forming two gimbal angle and command circuits for checkout of the RR shaft and trunnion servo loops. In the readout mode, the servo loops follow the gimbal angle data from the radar resolvers, convert it to a pulse format (using an incremental shaft encoder), and send it to up-down counters in the RSCS. In the program mode, the motors in the servo loops are driven by test signals from the programmer. The landing radar quadrature doppler signals are selected and routed to the RSCS for measurement and display.

5-11. LANDING RADAR ANTENNA CHECKOUT ADAPTER, PART NO. 410-31020.

The landing radar antenna checkout adapter, controlled by the Radar Section Checkout Station (RSCS), exercises the landing radar receiver channels during system checkout. The checkout adapter receives, through two waveguides, a portion of the landing radar transmitters signals and distributes, modulates, and attenuates the signals to provide coherent test stimuli to the receiver channels. The landing radar transmitter outputs are coupled through waveguide switches to the Single Sideband Modulator/SSBM) for stimulus insertion. The velocity sensor transmitter output is first split into three equal signals before modulation. The SSBM outputs are then attenuated and routed to the landing radar receiver test input. The RSCS controls all waveguide switches and programs the attenuators as test requirements dictate. Before stimulating the receiver, the RSCS selects the appropriate transmitter and SSBM outputs for transmission to the RSCS for measurement and calibration.

5-12. RENDEZVOUS RADAR AND LANDING RADAR MICROWAVE CHECKOUT ADAPTER, PART NO. 410-310-30.

The rendezvous radar and landing radar microwave checkout adapter (MCA), controlled by the Radar Section Checkout Station (RSCS), couples and routes microwave signals to the radar equipment during system checkout. The MCA is connected to the other radar section checkout adapters. The solenoid-operated waveguide switches and attenuators of the MCA are controlled by the RSCS to couple landing radar transmitter outputs from the landing radar checkout adapter to the RSCS for special display and measurement, to couple rendezvous radar transmitter outputs to the RSCS for measurement and provide receiver stimuli to check the rendezvous radar modes, and to couple rendezvous radar transmitter outputs directly to the corresponding transponder and transmit the transponder output to the receiver during RR/T compatibility tests.

5-13. C-BAND ANTENNA PROBE ASSEMBLY, PART NO. 410-32020.

The C-band antenna probe assembly is a portable test unit that consists of four antenna probes, a selector box, and r-f cables used to couple r-f energy from the LEM Beacon Antennas to Radar Transponder and Recovery Beacon Checkout Unit during system checkout. The antenna probes are mounted on the LEM exterior, covering the beacon antennas, and are hardlined to the beacon checkout unit during testing of such parameters as transmitter frequency and power output, reply pulse width, frequency and rise time, and receiver operation. The selector box allows switching from one antenna to the other to facilitate end-to-end testing of the beacons and antennas.

5-14. VHF IN-FLIGHT ANTENNAS ADAPTER ASSEMBLY, PART NO. 410-32060.

The VHF in-flight antennas adapter assembly is a portable test unit that consists of three antenna couplers, the antenna select switch box assembly, and r-f cables used to couple r-f energy between the LEM vhf antennas and the Communications Subsystem Maintenance Test Station during system checkout. The antenna couplers, which are constructed of r-f lossy material to suppress antenna radiation without substantially altering the antenna voltage-to-standing-wave-ratio, are mounted on the LEM exterior, covering the vhf antennas. The outputs of the couplers, selected by the switch box assembly, are either hardlined or transmitted through reradiating antennas to the maintenance test station for measurement and display of such parameters as transmitter frequency and power output, and receiver operation.

5-15. RANGING TEST ASSEMBLY, PART NO. 410-32120.

The ranging test assembly is a portable, manually controlled rack. The assembly verifies that the Pulse Ranging Network (PRN) ranging channel of the S-band airborne transponder responds correctly to PRN codes generated to simulate lunar or near-earth excursions. A Pulse Network (PN) encoding and decoding generator and a ranging receiver provide circuit parameters to check ranging mode delay, modulation phase detector output bandwidth, voltage-controlled oscillator (VCO) output, phase-modulated signal sensitivity, and signal interference. The assembly provides indication of test results, and has connectors for externally monitoring code components.

5-16. SIGNAL-SWITCHING RACK, PART NO. 410-32150.

The signal-switching rack consists of six rack-mounted panels; it permits the Radar Transponder and Recovery Beacon Checkout Unit and the Communications Subsystem Maintenance Test Station to be connected to any of nine vehicles during subsystem checkout. The rack contains provisions for amplifying, attenuating, and monitoring r-f signals between the vehicles and the test stations and for simultaneous testing of two or more different supported items in different vehicles.

5-17. PYROTECHNIC INITIATOR TEST SET, PART NO. 410-62050.

The pyrotechnic initiator test set is a self-powered portable meter used to verify the prefiring integrity of squib valve igniter bridgewires prior to vehicle installation. Testing is nondestructive but is normally conducted behind a protective shield to ensure the safety of the operator and the equipment. The pyrotechnic initiator test set measures and directly indicates the resistance (from zero to 30-ohms) of the squib valve bridgewire while maintaining the test current at a level well below the firing current of a single squib. Measurements are displayed by a four-place readout: shorted or open bridgewires are also indicated.

5-18. RCS PROPELLANT QUANTITY GAGING SYSTEM TEST SET, PART NO. 410-62080.

The RCS propellant quantity gaging system test set is used to perform an end-to-end electrical checkout and to calibrate the LEM RCS Propellant (fuel and oxidizer) Quantity Gaging System (PQGS) with

simulated tank loads. It is a portable test set containing two pairs of dummy fuel and oxidizer tanks that performs three major functions: (1) verify that the PQGS of the LEM is operating properly, (2) provide accurate readouts to enable calibration of the PQGS, and (3) isolate malfunctions to any one of the four onboard quantity sensor assemblies, or to the PQGS control unit. The PQGS Test Set has two major modes of operation and a self-test mode. The quantity sensor mode of operation is used to check the output of each quantity sensor assembly. The control unit mode enables monitoring and displaying both fuel quantities or both oxidizer quantities, and obtains these quantities directly from the PQGS control unit, as do the astronaut displays. A simple comparison between the test set readouts and a known quantity of propellant loaded into the LEM tanks will indicate whether the PQGS is operating properly. This mode can be used to verify proper operation of the PQGS control unit alone by simulating the quantity sensor inputs to the control unit. The operator then checks that the control unit quantity outputs correspond to the simulated inputs. Calibration of the PQGS control unit is accomplished in this mode by taking quantity readings when the LEM tanks are empty. The empty tank readings are used to determine the settings for the PQGS control unit calibration devices.

5-19. FLUID DISTRIBUTION SYSTEM VALVE BOX CONTROLLER, PART NO. 410-64130.

The fluid distribution system valve box controller is a manually operated portable electrical control and monitoring unit used with the following propulsion and RCS subsystem fluid distribution valve boxes: Propellant Loading Control Assembly (Fuel), Part No. 430-64430; Propellant Loading Control Assembly (Oxidizer), Part No. 430-64450; Helium Pressurization Distribution Unit, Part No. 430-64570, RCS Fuel Transfer Control Assembly, Part No. 430-64230; and RCS Oxidizer Transfer Control Assembly, Part No. 430-64240. The valve box controller controls and monitors the position of as many as 30 valves; monitors 9 transducer outputs (6 continuously, three on a time-shared basis); controls facility power to the controlled unit; provides indications of operating status and valve box purge pressure. Manually operated switches control valve positions, panel lamps indicate valve positions and event signals, and panel meters provide temperature and pressure indicators.

5-20. INITIATOR SIMULATOR TEST SET, PART NO. 410-82970.

The initiator simulator test set consists of initiator simulators that are used to replace each initiator in the vehicle. The test set simulates initiator bridgewire prefiring, firing, and post firing characteristics (simulators reset automatically); verifies system output current levels and duration via go-no go indications, with adjustable firing levels; and provide firing status and transient indications for the ACE-S/C Down-Link. Individual simulators are positioned in the vehicle and are connected to ACE-S/C by cabling. Simulator operation is initiated by manually actuating switches in the vehicle.

5-21. CARBON DIOXIDE PARTIAL PRESSURE SENSOR TEST SET, PART NO. 430-51110.

The carbon dioxide partial pressure test set is used to check the CO₂ partial pressure sensor, which is part of the Environmental Control Subsystem. The test set consists of a portable pressure sensor, which is a mobile test stand. It supplies electrical power from an integral battery pack to the sensor injects a measured mixture of carbon dioxide and oxygen and measures the flow rate, pressure, power input, and power output.

5-22. MASS SPECTROMETER PORTABLE LEAK TEST STAND, PART NO. 430-52010.

The mass spectrometer portable leak test stand is used in conjunction with a mass spectrometer to leak-test components of the Environmental Control Subsystem. The stand has a bell jar to house the components during the leak test and provisions for evacuating the bell jar and pressurizing the components with helium from a separate tank. It is suitable for use in a standard clean room.

5-23. GASEOUS COMPONENTS TEST BENCH, PART NO. 430-52120.

The gaseous components test bench is a test stand that consists of a pump, blowers, valving and plumbing, and controls and instrumentation. It is designed for use in a Class II clean room and is used to test all components of the atmosphere revitalization and oxygen supply sections. This unit is capable of measuring pressure-drop across components, testing flow rate, proof-testing of components, testing of electrical component efficiency, and determining internal and external leakage.

5-24. WATER COMPONENTS TEST STAND, PART NO. 430-52160.

The water components test stand is a test bench that contains a water pump and reservoir, a nitrogen purge section, a vacuum pump, a sink, a handpump, and the necessary instrumentation and connections. This test stand is used in a Class II clean room. An auxiliary unit accompanies this test stand and contains all the equipment requiring frequent maintenance and is located outside the clean room. The

test stand is used to supply a component under test with operational inputs; to pressurize a component for proof-test; to perform internal and external leakage tests; to determine the amount of water in the tanks; to perform functional tests of all pressure, differential pressure, fluid level, and valve position indicator sensors; and to purge and evacuate the water components.

5-25. WATER-GLYCOL COMPONENTS TEST STAND, PART NO. 430-52210.

The water-glycol components test stand is a test bench that contains a water-glycol pump and reservoir; a water flush pump and reservoir; a nitrogen purge system; a vacuum pump; a vacuum pump; a temperature control unit; a sink; a handpump; and the necessary instrumentation, plumbing and connections. This test stand is used in a Class II clean room. An auxiliary unit accompanies this test stand and contains all the equipment requiring frequent maintenance and is located outside the clean room. The test stand is used to supply components under test with operational inputs of water-glycol; to pressurize components for proof-pressure tests; to perform internal and external leakage tests; to perform functional tests of all pressure, differential pressure, speed, fluid level and valve position sensors; to test electrical efficiency of pump; and to flush, purge, and evacuate the water-glycol components.

5-26. CABIN LEAKAGE TEST UNIT, PART NO. 430-54400.

The cabin leakage test unit is a portable unit containing valves, flowmeters, a pressure regulator, plumbing, and pressure gages. This unit is used to measure leakage of the LEM cabin and to purge the LEM cabin with gaseous oxygen.

5-27. PROPELLANT LEVEL DETECTOR CHECKOUT UNIT, PART NO. 430-62030.

The propellant level detector checkout unit is a test unit for checking the propellant level detectors of the Ascent and Descent Propulsion Subsystems. The unit has a pressure vessel in which the propellant level detector is placed for the test; it measures the level at which the detector produces the required output signal.

5-28. RCS SCAVENGING ASSEMBLY, PART NO. 430-62040.

The RCS scavenging assembly collects flush fluids from the engines of the Reaction Control Subsystem after burn tests and conducts the fluids to the facility waste disposal provision. The assembly consists of four short flexible hoses with fittings that engage throat plugs on the engines, a manifold, and a final length of hose to conduct the fluids to the disposal provision. The entire assembly is in a carrying case.

5-29. ASCENT/DESCENT PROPELLANT SYSTEM CHECKOUT UNIT, PART NO. 430-62170.

The ascent/descent propellant system checkout unit is a mobile modulator unit that consists of a control subassembly, leakage flowmeter subassembly, and a Freon supply subassembly. It is used for performing internal and external leak tests and for functionally checking propellant sections of the Propulsion Subsystem. The unit supplies gaseous nitrogen and freon at regulated pressures for evaluating external and internal leakage.

5-30. SUPERCRITICAL HELIUM CHECKOUT TEST UNIT, PART NO. 430-62190.

The supercritical helium checkout test unit is used to test the supercritical helium supply section of the Propulsion Helium Pressurization System. The unit is portable and has provisions for checking heat leakage, helium leakage, propellant cold flow, and relief valve operation.

5-31. HALOGEN LEAK DETECTOR, PART NO. 430-62350.

The halogen leak detector is a portable unit that contains a sensing probe which includes an indicating meter, sensitivity knob, and a zero-set control. This unit is used to check out a propulsion feed system or component that has been pressurized with a tracer gas (freon). By passing the sensing probe over the compartment, this unit provides both a visual and audio signal, if a leak is present.

5-32. HELIUM-HYDROGEN MASS SPECTROMETER LEAK DETECTOR, PART NO. 430-82720.

The helium-hydrogen mass spectrometer leak detector is a portable unit that consists of a sniffer nozzle, flexible hose, leak indicator, alarm, control panel selector switch, vacuum pumps, valves, and associated mechanical and electrical equipment. Probing with the sniffer nozzle or performing a pressure vacuum test detects hydrogen and helium leakage. Leakage triggers an audio alarm and an indicator.

5-33. ATMOSPHERE REVITALIZATION CALIBRATION TEST SET, PART NO. 430-91033.

The atmosphere revitalization calibration test set is a unit that imposes the metabolic loading of 0 to 2 men upon the atmosphere revitalization section of the Environmental Control Subsystem during checkout. This unit is an item of common usage GSE.

5-34. SERVICING EQUIPMENT.**5-35. GASEOUS OXYGEN SUPPLY UNIT, PART NO. 430-54200.**

The gaseous oxygen supply unit is a mobile unit that contains a pressure regulator, valves, plumbing, a flowmeter, pressure gages, and a vacuum pump. It is used to evacuate the oxygen supply section of the Environmental Control Subsystem and to supply gaseous oxygen from the facility to charge the gaseous oxygen accumulator of the oxygen supply section. It also supplies gaseous oxygen to the ECS when the Electrical Power Subsystem supercritical oxygen tanks are not available.

5-36. WATER MANAGEMENT SECTION SERVICING VACUUM PUMP, PART NO. 430-54320.

The water management section servicing vacuum pump is a four-wheel cart that consists of a vacuum pump, controls, and instrumentation required for evacuating water vapor from the ECS water management section in conjunction with the Water Transfer Unit LSC-430-94119.

5-37. FREON SUPPLY UNIT, PART NO. 430-54600.

The freon supply unit is a skid-mounted unit that supplies Freon to the Freon boiler in the ECS heat transport section as a means of cooling when the trim control unit is disconnected during countdown. The unit is at the base of the Launch Umbilical Tower.

5-38. WATER-GLYCOL TRIM CONTROL UNIT, PART NO. 430-54700.

The water-glycol trim control unit is a portable unit located on the Launch Umbilical Tower and contains a heat exchanger, a pump, valves, a temperature controller, relief valves, plumbing, wiring, a heater, and a reservoir. This unit is used to flush, purge, evacuate and fill the heat transport loops with a water-glycol mixture, circulate the water-glycol mixture, and either add or remove heat from the mixture. A water-glycol mixture is supplied to this unit from the water-glycol service unit for heat transfer medium as well as flush and purge fluids.

5-39. SUPERCRITICAL HELIUM SUPPLY SYSTEM, PART NO. 430-64200.

The supercritical helium supply system charges the Ascent and Descent Pressurization System storage vessels with cryogenic supercritical helium. The system is capable of remote or local operation; it has provisions for precooling the associated transfer lines and pressurizing the helium system.

5-40. LIQUID NITROGEN STORAGE AND TRANSFER UNIT, PART NO. 430-64210.

The liquid nitrogen storage and transfer unit stores liquid nitrogen, supplies it to the precooler of the supercritical helium conditioning unit, and maintains the nitrogen level in the supercooler. The liquid nitrogen storage and transfer unit consists of a storage container, a subcooler, and connecting lines.

5-41. RCS FUEL TRANSFER CONTROL ASSEMBLY, PART NO. 430-64230.

The RCS fuel transfer control assembly controls the loading of fuel into the two fuel bladder tanks of the Reaction Control Subsystem. It also provides for draining the tanks; venting or pressurizing the helium sides of the bladders; and unloading, purging, and draining the propellant transfer lines. The assembly consists of a valve box with manual controls, and an electrical purge box with logic circuits.

5-42. RCS OXIDIZER TRANSFER CONTROL ASSEMBLY, PART NO. 430-64240.

The RCS oxidizer transfer control assembly controls the loading of oxidizer into the two oxidizer bladder tanks of the Reaction Control Subsystem. It also provides for draining the tanks; venting or pressurizing the helium sides of the bladders; and unloading, purging, and draining the propellant transfer lines. The assembly consists of a valve box with manual controls, and an electrical purge box with logic circuits.

5-43. HELIUM STORAGE AND TRANSFER DEWAR, PART NO. 430-64260.

The helium storage and transfer dewar stores and transfers liquid helium. It is used to transport the helium to the vehicle site and transfer the helium to the supply system boiler and the spacecraft storage boilers.

5-44. FUEL LOADING CONTROL ASSEMBLY, PART NO. 430-64430.

The Fuel Loading Control Assembly is of modular construction and consists of a flow control system, the necessary controls and instrumentation, and provisions to isolate major components for replacement and maintenance. It is capable of being used in an unsheltered location where vibrations, noise, and explosive gases are present. When connected, the unit provides a remotely operated means of controlled propellant fuel loading, detanking, and purging of the ascent and descent fuel storage tanks. The unit is remotely controlled by the Propellant Loading Control Assembly Controller.

5-45. OXIDIZER LOADING CONTROL ASSEMBLY, PART NO. 430-64450.

The Oxidizer Loading Control Assembly is of modular construction and contains a flow control system, the necessary controls and instrumentation, and provisions to isolate major components for replacement and maintenance. It is capable of being used in an unsheltered location where vibrations, noise, and explosive gases are present. When connected, the unit provides a remotely operated means of controlled propellant oxidizer loading, detanking, and purging of the ascent and descent oxidizer storage tanks. The unit is remotely controlled by the Propellant Loading Control Assembly Controller.

5-46. PRESSURE MAINTENANCE UNIT, PART NO. 430-64500.

The Pressure Maintenance Unit is a portable item that maintains the propulsion fuel and oxidizer tanks and feed lines in a clean, dry, pressurized state to prevent contamination and maintains pressure differentials to prevent collapsing of tanks during air and ground transportation and storage. It also maintains the pressure in the LEM cabin during transportation. The unit provides control of clean, dry, regulated gas for pressurization of the Propulsion and RCS helium systems, the RCS propellant subsystem, and the ECS water management section, heat transport section, and oxygen supply section before sealing for transportation and storage.

5-47. PROPULSION SYSTEMS HELIUM PRESSURE DISTRIBUTION ASSEMBLY, PART NO. 430-64570.

The propulsion systems helium pressure distribution assembly distributes and controls helium in the filling of the helium pressurization tanks for the RCS and Propulsion Subsystems of the LEM test vehicle. The assembly consists of a distribution manifold and five fill units.

5-48. RCS NOZZLE TO FLUID DISPOSAL ADAPTER SET, PART NO. 430-91146.

The RCS nozzle to fluid disposal adapter set includes sixteen 4-way adapter assemblies and a carrying case. It provides a leak-tight connection between the RCS engines and test or scavenging equipment.

5-49. OXIDIZER TRANSFER AND CONDITIONING UNIT, PART NO. 430-94002.

The Oxidizer Transfer and Conditioning Unit is a four-wheel cart consisting of a temperature control section, a heat transfer section, an oxidizer section, and the necessary controls and instrumentation. When loading the ascent and descent stage oxidizer tanks with oxidizer (nitrogen tetroxide - N_2O_4), this unit controls the temperature of the oxidizer in the range from 30° to $135^\circ F$. It requires a minimum time of 2 hours to condition the 1,200 gallons of oxidizer from an ambient temperature of 40° to $80^\circ F$ to either extremes of temperature. At the Static Test Area, this unit is remotely controlled by the Propellant Control Station. This unit is an item of concurrent usage GSE, modified for LEM use.

5-50. FUEL TRANSFER AND CONDITIONING UNIT, PART NO. 430-94008.

The Fuel Transfer and Conditioning Unit is a four-wheel cart consisting of a temperature control section, a heat transfer section, a fuel section, and the necessary controls and instrumentation. When loading the fuel tanks with propellant (unsymmetrical dimethylhydrazine - UDMH) H_2H_4 , this unit controls the temperature of the fuel being transferred. At the Static Test Area, this unit is remotely controlled by the Propellant Control Station. This unit is an item of common usage GSE, modified for LEM use.

5-51. HELIUM TRANSFER AND CONDITIONER UNIT, PART NO. 430-94009.

The Helium Transfer and Conditioner Unit is a completely enclosed four-wheel unit for use in an outdoor, unsheltered location. It contains a gas flow control system, a heat exchanger, and an electrical

system. The unit is positioned at the base of the launch tower with its inlet port connected to the helium supply and its outlet port connected to the helium distribution lines. In this configuration, conditioned gaseous helium is transferred from the storage unit to the LEM Propulsion and Reaction Control Subsystem helium tanks. This unit is remotely controlled by the Pneumatics Control Station when used at the Static Test Area, and it is an item of common usage GSE.

5-52. WATER-GLYCOL SERVICE UNIT, PART NO. 430-94019.

The Water-Glycol Service Unit is located at the base of the Launch Umbilical Tower and contains pumps, reservoirs, an accumulator, heaters, and plumbing. This unit is used to supply a glycol mixture, distilled water, and gaseous nitrogen to the Water-Glycol Trim Control Unit. It is also used to evacuate the ECS heat transport section. This cooling requirement must be met to remove heat from the LEM during prelaunch checkout. This unit is an item of common usage GSE.

5-53. HELIUM BOOSTER CART, PART NO. 430-94022.

The Helium Booster Cart is a four-wheel cart that contains a boost pump, an electrically driven power system, inter- and after-coolers, and electrical and pneumatic controls. With the cart connected between the Helium Storage Trailer and the helium supply source, the boost pump establishes equilibrium pressure between the supply source and storage trailer and boosts the pressure of the Helium Storage Trailer. This unit is an item of common usage GSE. At the Static Test Area, the operation of this unit is monitored by the Pneumatics Control Station, which controls the power interlock emergency shutdown devices of this unit.

5-54. WATER-GLYCOL COOLING UNIT, PART NO. 430-94052.

The Water-Glycol Cooling Unit removes heat loads from the ECS water-glycol circulating loop by circulating temperature-conditioned water-glycol through the fluid distribution system network to the ECS water-glycol Trim Control Unit system. The unit contains water-glycol storage facilities and flow, pressure, and temperature controls to fill, drain, and purge the fluid distribution and ECS water-glycol Trim Control Unit systems with gaseous nitrogen. It is used at the Radio Frequency Systems Test Building. It is an item of common usage.

5-55. RCS OXIDIZER SERVICING UNIT, PART NO. 430-94057.

The RCS Oxidizer Servicing Unit is a mobile unit that contains a holding tank, oxidizer pumping and control system, measuring system, thermal conditioning system, filters, nitrogen pressurization and an evacuation system, a control and instrumentation panel, vehicle and hardline adapter hoses, and a remote control unit. With the servicing unit connected to the RCS Oxidizer Transfer Control Unit, this unit will supply, condition, and control the oxidizer to the RCS tanks. Upon completion of the fill mode, it will unload RCS tanks, then drain and purge the RCS Oxidizer Transfer Control Unit along with the Fluid Distribution System. At the Static Test Area, this unit is remotely controlled by the RCS Stand Control Station. This unit is an item of common usage GSE modified for LEM use.

5-56. FUEL READY STORAGE UNIT, PART NO. 430-94058.

The Fuel Ready Storage Unit is a four-wheel cart that consists of a 5300 gallon storage tank and a transfer system with the necessary controls and instrumentation. With the transfer system in operation, the propellant (UDMH) is transferred to the LEM propellant tanks. This unit also can recirculate and store off-load propellant from the LEM propellant tanks. This unit is used in conjunction with the Fuel Transfer Control Unit and is an item of concurrent usage GSE. At the Static Test Area, this unit is remotely controlled by the Propellant Control Station.

5-57. OXIDIZER READY STORAGE UNIT, PART NO. 430-94059.

The Oxidizer Ready Storage Unit is a four-wheel unit that consists of a 1500 gallon storage tank and a transfer system with the necessary controls and instrumentation. With the transfer system in operation, the oxidizer (N_2O_4) is transferred to the LEM oxidizer tanks. Also, this unit can recirculate and off-load the oxidizer from the LEM oxidizer tanks. The unit is used in conjunction with the Oxidizer Transfer Control Unit and is an item of common usage GSE, modified for LEM use. This unit is remotely controlled by the Propellant Control Station.

5-58. FUEL VAPOR DISPOSAL UNIT, PART NO. 430-94060.

The Fuel Vapor Disposal Unit is a skid-mounted assembly module consisting of a gas processing system with the necessary controls and instrumentation. It is used to safely dispose of fuel vapors

generated during the thermal conditioning of the fuel, during the nitrogen purging of the fuel system, and during the fuel loading operation. This unit is an item of concurrent usage GSE.

5-59. OXIDIZER VAPOR DISPOSAL UNIT, PART NO. 430-94061.

The Oxidizer Vapor Disposal Unit is a skid-mounted assembly module consisting of a gas processing system with the necessary controls and instrumentation. It is used to safely dispose of oxidizer vapors generated during the thermal conditioning of the oxidizer, during the nitrogen purging of the system, and during the oxidizer loading operation. This unit is an item of common usage GSE. At the Static Test Area, this unit is remotely controlled by the Propellant Control Station.

5-60. HELIUM STORAGE TRAILER, PART NO. 430-94062.

The Helium Storage Trailer is an eight-wheel, pneumatic tire, semitrailer. Mounted on the trailer are gas cylinders, which are filled from the facility helium source using the Helium Booster Cart. The LEM helium tanks are pressurized and filled from these cylinders by blowing down through the Helium Transfer and Conditioner Unit. The helium stored in the gas cylinders is sufficient to provide two fillings of the Propulsion and Reaction Control Subsystem tanks to proper pressure. This unit is an item of common usage GSE.

5-61. RCS FUEL SERVICING UNIT, PART NO. 430-94063.

The RCS Fuel Servicing Unit is a mobile unit containing a holding tank, a fuel pumping and control system, a measuring system, a thermal conditioning system, filters, a nitrogen pressurization and evacuation system, a control and instrumentation panel, vehicle and hardline adapter hoses, and a remote control unit. With this servicing unit connected to the RCS Fuel Transfer Control Unit, this unit will supply, condition and control the fuel to the RCS tanks. Upon completion of the fill mode, it will unload the RCS tanks, then drain and purge the RCS Fuel Transfer Control Unit along with the Fluid Distribution System. At the Static Test Area, this unit is remotely controlled by the RCS Stand Control Station. This servicing unit is an item of common usage GSE modified for LEM use.

5-62. WATER SUPPLY UNIT, PART NO. 430-94119.

The Water Supply Unit is a mobile unit that contains a pump, a reservoir, starters, tubing, valving and controls, remote and manual controls, explosion-proofing and instrumentation. It is used in the LEM Environmental Control Subsystem to fill the water management section with triple-distilled water. This unit is an item of common usage GSE modified for LEM use.

5-63. HANDLING EQUIPMENT AND FIXTURES.

5-64. DOLLIES AND STANDS.

The following special dollies and stands facilitate handling the LEM test rigs and support equipment:

Ascent Stage Handling Dolly, Part No. 420-13300

Descent Stage Handling Dolly, Part No. 420-13550

Cabin Equipment Installation Dolly, Part No. 420-53100

Ascent Engine Dolly, Part No. 420-63200

Descent Stage Engine Installation Dolly, Part No. 420-63400

Ascent Stage Propellant Tank Dolly, Part No. 420-63920

Descent Stage Propellant Tank Dolly, Part No. 420-63980

Ascent Stage Workstand, Part No. 420-13400

Descent Stage Workstand, Part No. 420-13650

Descent Stage Support Stand, Part No. 420-13700

ACE-S/C Support Platform, Part No. 420-73100

LMA790-1

Descent Stage Battery Installation Fixture, Part No. 420-83220.

Ascent Stage Battery Installation Fixture, Part No. 420-83270.

5-65. SLINGS.

The following slings facilitate handling the LEM test rigs and support equipment:

Ascent Stage Hoisting Sling, Part No. 420-13100

Descent Stage Hoisting Sling, Part No. 420-13600

Ascent Stage Propellant Tank Sling, Part No. 420-63231

Ascent Engine Sling, Part No. 420-63300

Descent Engine Installation Sling, Part No. 420-63500.

Descent Engine Turnover Sling, Part No. 420-63511

Ascent Stage Propellant Tank Sling, Part No. 420-63940.

5-66. FIXTURES AND INSTALLATION KITS.

The following fixtures and installation kits are used for the LEM test rigs and support equipment:

Ascent Stage Fitting Set, Part No. 420-13036

Docking Test Fixture, Part No. 420-13210

Landing Radar Antenna Handling and Installation Kit, Part No. 420-33003

Cabin Equipment Installation Fixture, Part No. 420-53200

RCS Cluster Assembly Mounting Fixture, Part No. 420-63114

Descent Stage Propellant Tank Installation Fixture, Part No. 420-63150

Helium Tank Handling Fixture, Part No. 420-63380

VHF In-Flight Antenna Coupler Support, Part No. 420-33001

Battery Hoist, Part No. 420-83260

Battery Handling Rail Assembly, Part No. 420-83250.

5-67. TRACTOR TRUCK, PART NO. 420-63230.

The tractor truck is 2-1/2-ton vehicle for towing semitrailers and other transportation vehicles. It is used to move equipment from aircraft offloading areas to the preparation and test areas. The tractor truck has six wheels and pneumatic brakes.

5-68. WHEELED WAREHOUSE TRACTOR, PART NO. 420-13330.

The wheeled warehouse tractor is a heavy-duty gasoline-powered, industrial-type towing vehicle with a rated travel speed of 14 miles per hour. The tractor is used to tow LEM test rigs, tanks, and other heavy equipment over paved and unpaved surfaces.

5-69. LEVEL LOADING CARGO LIFT TRAILER, PART NO. 420-63250.

The level loading cargo lift trailer (CLT) consists of a steel frame chassis mounted on a fore and aft suspension system, which uses an externally actuated power leveling system. A power steering system at each end effects individual wheel control. The trailer is powered by a gasoline driven engine and contains lighting and brake systems. A tow bar mounted at the forward end provides coupling for a prime mover. The loading platform is raised and lowered with a hydraulic-mechanical lift system. The CLT can transport a loaded pallet from a facilities loading area to an aircraft parking ramp,

accurately positioned in line with the aircraft cargo deck. To load the general cargo pallet into the B-377PG aircraft, the hydraulic system is actuated and the CLT deck is raised to the aircraft deck level. The pallet is then skidded aboard the aircraft and secured.

5-70. DESCENT STAGE TRANSPORTER, PART NO. 420-13500. The descent stage transporter supports, secures, and protects the LEM descent stage test rig during transportation. The transporter consists of a wheeled platform and chassis frame, a suspension system, and a protective cover.

5-71. MANUALLY OPERATED HOIST, PART NO. 420-63220.

The manually operated hoist is portable, and operated with a handcrank. It is used in installation and removal of the descent stage propulsion tanks and engine. The ratio of crank revolutions to cable travel is high, providing fine control of load position.

5-72. ASCENT STAGE ENGINE PLUG AND SUPPORT KIT, PART NO. 420-63120.

The ascent stage engine plug and support kit consists of an expandable rubber cylinder (called a throat plug) attached to a hollow telescoping tube with a base plate at the other end. The plug can seal the ascent engine for a static pressure test of 120 psi using gaseous nitrogen. The support frame is a box-type weldment, contoured to clear vehicle protrusions and truss-framed with four casters to support the engine.

5-73. TEMPERATURE-CONTROLLED BATTERY STORAGE RACK, PART NO. 420-83280.

The temperature-controlled battery storage rack provides the required storage conditions for ascent and descent stage primary batteries after they are activated. The rack has 12 individual compartments for batteries and includes equipment that maintains the temperature between 45° and 50°F and the relative humidity between 45% and 50%. Some associated equipment can be stored in the rack.

5-74. POLARITY CHECKER, PART NO. 420-93089.

The polarity checker supports and positions the LEM for tests of the end-to-end phasing of the propulsion and display subsystems. The polarity checker moves the LEM about its roll, pitch, and yaw axes. Power-driven hydraulic cylinders and an electric motor produce the required motions.

5-75. CABIN CLEANLINESS ENCLOSURE, PART NO. 420-11010.

The cabin cleanliness enclosure is a chamber that is assembled to the entrance to the vehicle crew compartment during test and maintenance operations. It maintains the cabin at the prescribed cleanliness level. Provision is made for personnel to put on clean room garments and prepare for clean room practices before entering the crew compartment.

5-76. DESCENT ENGINE PLUG ASSEMBLY, PART NO. 420-63420.

The descent engine plug assembly is used to stopper the throat of the descent engine during leakage tests. It is a self-supporting and self-locking device that locks in place by means of locking arms that operate in umbrella fashion. The assembly includes an integral pressure-relief valve.

5-77. DESCENT STAGE FITTING ASSEMBLY, PART NO. 420-13031.

The descent stage fitting assembly provides a structural interface connection between the descent stage outrigger support corner post fittings and a supporting structure, transporter, handling dolly, or support stand. The fitting assembly also compensates for angular misalignment between the descent stage and its supporting structure. A fitting consists basically of a machined housing and a yoke pin. The housing contains a spherical bearing and retainer assembly, a thrust bushing, and spacers. The yoke pin and attaching hardware is used to secure the corner post fittings to the handling equipment.

5-78. AUXILIARY CRANE CONTROL, PART NO. 420-13060.

The auxiliary crane control is a self-contained, hydraulically operated unit that interconnects between the appropriate hoisting sling and the lifting device through the upper and lower eyebolt fittings. The unit consists of an upper and lower eyebolt; a return lift dial; a scale dial; up and down valve levers; a plunger rod; and two control reels, each with 40 feet of nylon-covered steel cable. This control operates independently of the lifting device and hoisting sling; if can raise and lower loads up to 5 tons a distance of 12 inches with an accuracy to within 0.001 inch or less. The cables are attached to the lever controls and afford operation of the unit from a distance.

5-79. PORTABLE CLEAN ENVIRONMENTAL KIT, PART NO. 420-13130.

The portable clean environmental kit maintains a clean room atmosphere and removes contaminants from the air within an enclosed area around the LEM during installation or removal of components and mating of interfaces. The kit filters ambient (contaminated) air and discharges the clean air inside the kit in a laminar flow pattern strong enough to overcome interior turbulence (hand motions or body movements). The kit consists of a housing that contains the blower, a filtering system with replaceable element, an atmospheric intake and exhaust connection, flexible tubing, clear plastic flexible tent with ties and zippers, and a bag to store the flexible tubing and tent when not in use.

5-80. SLA INTERNAL WORK PLATFORM, PART NO. 420-93176.

The SLA internal work platform is a two-level platform installed inside the Command and Service module-LEM adapter. The platform supports personnel working in the adapter when the Apollo vehicle is stacked.

5-81. NAVIGATION BASE ALIGNMENT GAGE, PART NO. 420-13361.

The navigational base alignment gage contains a mirror reference gage for alignment of the Grumman navigation base and for alignment checks on the radar antennas and the ascent and descent engines. The gage consists of a U-shaped base, a mirror cube, and three ball inserts that mate with the navigation base. The mirror cube is used in conjunction with an optical alignment fixture.

5-82. DESCENT STAGE PROTECTIVE COVER, PART NO. 420-13480.

The descent stage protective cover is fabricated from vinyl-coated, white nylon fabric and is form fitted to the descent stage contour. The cover completely encloses the descent stage and has cutouts for access to all hoisting and support points. The cover keeps the descent stage clean and protects it against adverse environmental conditions.

5-83. ASCENT STAGE PROTECTIVE COVER, PART NO. 420-13520.

The ascent stage protective cover is fabricated from vinyl-coated, white nylon fabric and is form fitted to the ascent stage contour. The cover completely encloses the ascent stage and has cutouts for access to all hoisting and support points. The cover keeps the ascent stage clean and protects it against environmental hazards.

5-84. BENCH MAINTENANCE EQUIPMENT.

Bench Maintenance Equipment (BME) is presented in Tables 5-1 through 5-6 according to the subsystem or section to which the equipment applies.

Table 5-1. Guidance and Navigation Section BME

Nomenclature	Used to check and troubleshoot:
Radar maintenance test station, Part No. 410-32520	Landing radar and rendezvous radar/transponder to replaceable component level; simulates analog and digital inputs and special sync pulses; checks range and altitude measuring capabilities; measures range signal stability and long-time frequency stability of oscillator sections; records outputs; and displays spectral waveforms for periodic maintenance, overhaul, and calibration.

Table 5-2. Stabilization and Control Section BME

Nomenclature	Used to check and troubleshoot:
<p>Abort guidance section maintenance test station, Part No. 410-22020.</p> <p>Control electronics section maintenance test section, Part No. 410-22040</p> <p>Command control section test station, Part No. 410-22950</p>	<p>The complete abort guidance section or its assemblies, which are the sensor assembly, electronics assembly, and abort programmer assembly to the replaceable component level.</p> <p>The complete stabilization and control subsystem of the control electronics section (CES) or its assemblies, which are: the rate gyro assembly, descent engine control assembly, attitude controller, trans-lation controller, and gimbal drive actuator assembly; and the complete in-flight monitor assembly to the replaceable component level.</p>
	<p>The program reader assembly and the program coupler assembly which comprise the command control section. The test station provides the following: power, stimuli, and the capability to isolate a malfunction to the lowest replaceable assembly of the command control section. In addition, the test station can be used in an integrated subsystem test.</p>

Table 5-3. Electrical Power Subsystem BME

Nomenclature	Used to check and troubleshoot:
<p>Power distribution maintenance test station, Part No. 410-82200</p> <p>General purpose inverter test station, Part No. 410-82300</p> <p>Battery maintenance test station, Part No. 410-82400</p>	<p>Power distribution section to replaceable assembly level; measures input and output voltage and current (steady state), continuity and logic, response times, and transients.</p> <p>Inverter assembly to replaceable subassembly level by applying variable power factor a-c loads and variable d-c voltage inputs, while monitoring frequency regulation, voltage regulation, transient response, harmonic distortion, and critical waveforms.</p> <p>Battery assemblies to the replaceable component level, while providing the proper loading manually or automatically; measures ampere-hour rating, regulation (static and transient), transducer calibration, and charge-discharge capabilities.</p>

Table 5-4. Communications Subsystem BME

Nomenclature	Used to check and troubleshoot:
<p>S-Band and communication console, Part No. 410-32280</p> <p>Antennas maintenance test station, Part No. 410-32440</p> <p>Radar Transponder and recovery beacon checkout unit, Part No. 410-92112</p>	<p>The LEM S-Band equipment and Communication Subsystem. The following general S-Band tests, as well as other more specific, tests are performed: voltage standing wave ratio and impedances, center frequencies and bandwidth, modulation characteristics, stability, ac and dc characteristics and power levels. The communication console supplies stimuli to the communication subsystem, receives and processes subsystem data, and provides displays indicating subsystem headline and open loop performance.</p> <p>Communications subsystem UHF, VHF, S-band and C-band antennas; and electronics and gimbal system of steerable antenna; checks VSWR, operating frequencies, impedances, and insertion losses.</p> <p>The AN/DPN-66 Transponder operational characteristics. The operating parameters of the transmitter, receiver, and power supply are exercised and checked.</p>

Table 5-5. Controls and Displays BME

Nomenclature	Used to check and troubleshoot:
<p>Displays and controls maintenance test station, Part No. 410-42100</p>	<p>The following units to a replaceable component level: ball attitude indicator; flight control, reaction control, and environmental control panels; radar, power generation, and power distribution panels; stabilization and control, and main propulsion (ascent/descent) panels; communications and audio control panels.</p>

Table 5-6. Instrumentation Subsystem BME

Nomenclature	Used to check and troubleshoot:
<p>Spacecraft Instrumentation Test Equipment (SITE)*, Part No. 410-92405</p> <p>Digital test command system test set, Part No. 410-92470</p>	<p>Instrumentation Subsystem and ACE-S/C Down-Link. SITE enables checkout of an entire Instrumentation Subsystem or ACE-S/C Down-Link; a section (grouping of interrelated assemblies) of either of these equipments, or individual assemblies of either of these equipments.</p> <p>The ACE digital test command system on the system and subsystem levels. The test set supplies and monitors serial inputs and serial and parallel outputs. The commands are programmed manually or from a punched tape input and the outputs of the equipment under test are displayed on panel instruments.</p>

*Used on both LEM and Command/Service Modules (common usage)

APPENDIX A
LEM SUPPORT MANUALS

A-1. GENERAL.

LEM support manuals are categorized by function, and are provided as ground support equipment (GSE) manuals, special test equipment (STE) manuals, and general-purpose handbooks and manuals.

A-2. GROUND SUPPORT EQUIPMENT MANUALS.

A support manual for each item of GSE provides pertinent operation and maintenance data. The manuals contain physical and functional description of the equipment covered, and data relative to its installation, operation, and maintenance at test sites. Support manuals prepared for GSE are listed in table A-1.

Table A-1. Ground Support Equipment Manuals

Manual Number	Issue/Rev Date	Title
LMA790-8-62220	13 Jan 1965	Engine Firing Control Station
LMA790-8-64420	20 July 1965	Propellant Loading Control Assembly
LMA790-8-62850	20 May 1965	Propulsion Subsystem Checkout Station
LMA790-8-64020	15 April 1965	Propellant Loading Control Assembly Controller
LMA790-8-64018	15 Sept 1965	Helium Distribution Unit Controller
LMA790-8-64220	15 Sept 1965	Helium Distribution Unit
LMA790-8-62110	15 Mar 1965	Helium Components Test Stand
LMA790-8-62170	25 Mar 1965	A/D Propellant Section Checkout Assembly
LMA790-8-62180	25 Mar 1965	Propulsion Systems Checkout Cart
LMA790-8-62160	31 May 1965	A/D Ullage Simulation Cart
LMA790-8-64660	5 June 1965	Facility Propellant Control Station
LMA790-8-64580	31 May 1965	Helium Pressurization Control Station
LMA790-8-6100	25 June 1965	Weigh Tank Calibration Unit
LMA790-8-62900	30 June 1965	Test Conductor Console

A-3. SPECIAL TEST EQUIPMENT MANUALS.

Each special test equipment (STE) has its own manual which provides description, operation instructions, maintenance, and calibration procedures, as applicable. Support manuals prepared for STE are listed in table A-2.

Table A-2. Special Test Equipment Manuals

Manual Number	Issue/Rev Date	Title
LED790-M-3	10 July 1964	M-3 Interface Capability Mockup
LED790-HD-2	5 June 1964	HD-2 Propulsion Test Rig
LED790-HA-2	15 June 1964	HA-2 Propulsion Test Rig
LED790-HD-3	30 June 1964	HD-3 Propulsion Test Rig
LED790-HA-3	10 June 1965	HA-3 Propulsion Test Rig
LED790-6710	20 Apr 1965	Fluid Distribution System
LED790-6090	6 Nov 1964	Ascent Engine Simulator
LED790-6670	15 Feb 1965	Nitrogen/Helium Pressurization Unit
LED790-12040	15 Mar 1965	Data Acquisition System Monitoring Panel
LED790-6949	25 June 1965	Nitrogen/Helium Pressurization Unit Controller
LED790-HD-4	25 Mar 1965	HD-4 Propulsion Test Rig
LED790-6150	15 Apr 1965	Descent Engine Simulator
LED790-1150	20 May 1965	RCS Vacuum Test Cart Assemblies
LED790-PD-1	20 May 1965	PD-1 Propulsion Test Rig
LED790-6930	25 June 1965	Fluid Distribution System MSC/WSO Test Stand No. 1
LED790-HA-4	25 May 1965	HA-4 Propulsion Test Rig
LED790-12010	26 Aug 1965	Data Acquisition System

A-4. GENERAL-PURPOSE HANDBOOKS AND MANUALS.

There are several types of handbooks and manuals included in this category. A familiarization Manual presents a general, overall description of the LEM. Coverage includes the LEM mission, the LEM structure, operational subsystems, prelaunch operations, and a brief description of GSE. A Description Manual, and a Transportation and Handling Manual for LEM test articles (LTA's) are provided for LTA-2 and LTA-10. The Preliminary Apollo Operations Handbook (AOH) - LEM provides detailed LEM operating instructions and procedures for use by the astronauts during a manned lunar mission. The handbook includes normal, backup, and contingency procedures, as well as conditions requiring an abort, and abort procedures. All subsystems and their interface relationships are covered in detail. Controls and displays, subsystem, schematics, crew personal equipment, in-flight preventive maintenance, and mission tasks are covered in this preliminary AOH. General-purpose handbooks and manuals are listed in table A-3.

Table A-3. General-Purpose Handbooks and Manuals

Manual Number	Issue/Rev Date	Title
LMA790-1	15 Oct 1965	Familiarization Manual
LMA790-2-LTA-2	10 Feb 1965	LTA-2 Description Manual
LMA790-5-LTA-2	10 Feb 1965	LTA-2 Transportation and Handling Manual
LMA790-2-LTA-10	20 Apr 1965	LTA-10 Description Manual
LMA790-5-LTA-10	20 Apr 1965	LTA-10 Transportation and Handling Manual
LMA790-3	15 Aug 1965	Preliminary Apollo Operations Handbook - LEM