

In this issue



Kinross incident: introduction, p. 3.

Kinross: a deadly encounter, p. 3.

Kinross: posing some questions, p. 8.

Kinross: another version, p. 13.

Calendar, p. 13.

UFO Press: *The Truth About UFOs and Aliens* p. 16.

Australian UFO wave an admitted hoax, p. 16.

CMS cell phone paging now available, p. 16.

UFO Marketplace, p. 23.

Columns

Director's Message	2
Filer's Files	14
Ted Phillips	18
Stan Friedman	20
Gavin McLeod	24

October 2006

No. 462

\$4.00

MUFON

Mutual UFO Network

UFO JOURNAL

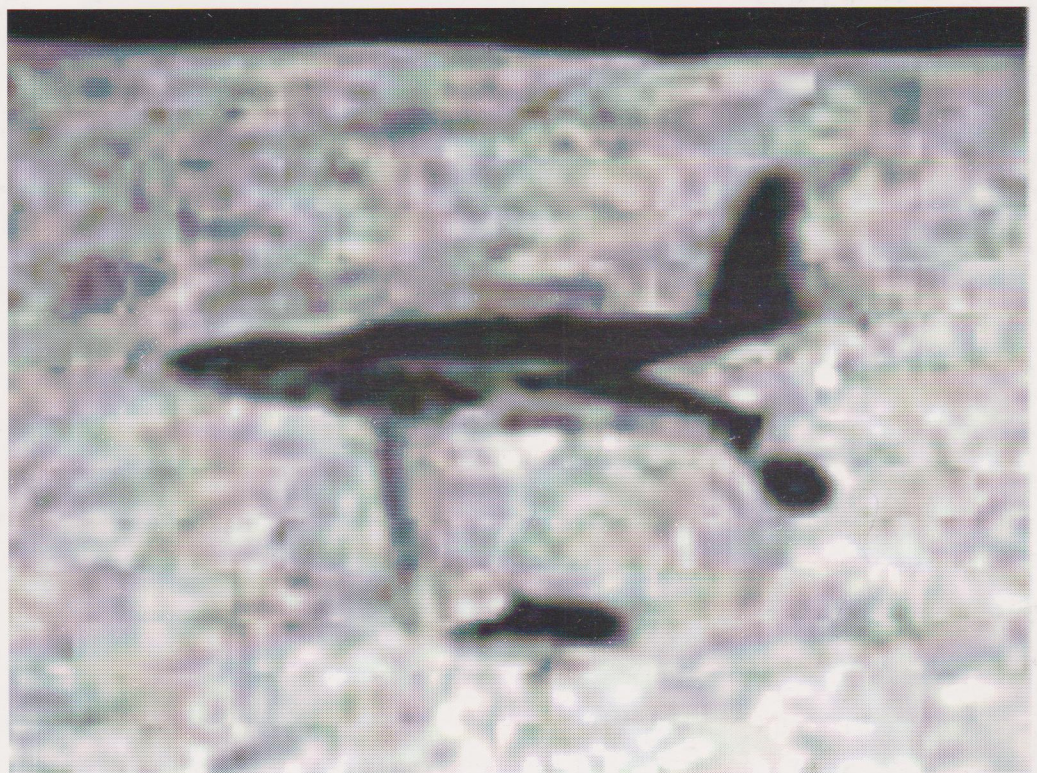

Is this the U.S. Air Force F-89C that has been missing since 1953 after apparently merging or colliding with an unknown object over Lake Superior? An individual or group calling itself the Great Lakes Dive Company claims to have located the aircraft, made sonar scans (as above), and verified its identity. However, MUFON has thus far been unable to verify that the claims are legitimate, and there are several indications that they are not. The articles begin on page 3.

MUFON

UFO Journal

(USPS 002-970)
(ISSN 0270-6822)

Mutual UFO Network

Post Office Box 369
Morrison, CO 80465-0369
Tel: 303-932-7709
Fax: 303-932-9279
mufonhq@aol.com

International Director

John F. Schuessler, M.S.
Tel: 303-932-7709
schuessler@mho.net

International Director Elect

James Carrion, M.S.
P.O. Box 279
Bellevue, CO 80512-0279
Tel: 970-221-1836 (221-1UFO)
Fax: 970-221-1209
jcarrion@mntview.com

Editor:

Dwight Connelly, M.S.
14026 Ridgelawn Road
Martinsville, IL 62442
mufonufjournal@hotmail.com

Columnists:

George Filer, M.B.A.
Stanton Friedman, M.S.
Gavin A. J. McLeod
Ted Phillips

Staff artist

John Egerton

MUFON staff photographer

Nick Roesler

MUFON on the Internet:

<http://www.mufon.com>

MUFON Amateur Radio Net:

40 meters - 7.240 MHz
Sundays noon EST or EDST

Directors' Message

By John F. Schuessler & James Carrion



New MUFON address

A new MUFON Headquarters office has been opened in Bellvue, CO, and will be operational by Nov. 1, 2006. All mail sent to MUFON Headquarters after Oct. 31, 2006, must be addressed to:
MUFON, Post Office Box 279, Bellvue, CO 80512-0279.

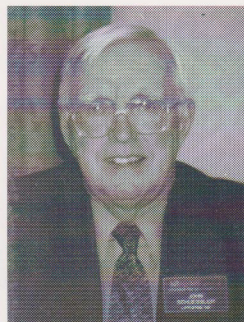

John Schuessler

New Lifetime Members

It is a pleasure to recognize **Robert W. Tea, Jr.** of El Cajon, CA; **Katharina Wilson** of Plano, TX; and **Leslie Varnicle** of Elizabeth, CO, as new MUFON Lifetime Members.

We are extremely grateful for this vote of confidence and outstanding level of support for MUFON.

We are saddened by the passing of lifetime member **Sheldon Gunnerson** of Clare, MI. Our condolences go to

his family and friends.

Position Announcements

Myron Ilkiw of Currambine, Perth, Western Australia, has accepted the position of Research Specialist in Physics.



James Carrion

Donna Geller of Enid, OK, has accepted the position of Research Specialist in Clinical Psychology.

Richard Blalack of Way-side, NJ, has accepted the position of Consultant in Business Administration.

New Field Investigators

Kathleen Marden, Director of Field Investigator Training, has announced that **Kenneth A. Bach** of Tucson, AZ; **Douglas Baker** of Muncie,

(Continued on page 22)

Change of address and subscription/extra copies inquiries should be sent to MUFON, P.O. Box 369, Morrison, CO 80465-0369.

Copyright 2006 by the Mutual UFO Network. All Rights Reserved

No part of this document may be reproduced in any form without the written permission of the Copyright Owners. Permission is hereby granted to quote up to 200 words of any one article, provided the author is credited, and the statement, "Copyright 2006 by the Mutual UFO Network, P.O. Box 369, Morrison, CO 80465-0369" is included.

The contents of the *MUFON UFO Journal* are determined by the editor, and do not necessarily reflect the official position of the Mutual UFO Network. Opinions expressed are solely those of the individual authors and columnists, and do not necessarily reflect the opinion of the editor or staff of MUFON.

The Mutual UFO Network, Inc. is exempt from Federal Income Tax under Section 501 (c) (3) of the Internal Revenue Code. MUFON is a publicly supported organization of the type described in Section 509 (a) (2). Donors may deduct contributions from their Federal Income Tax. Bequests, legacies, devises, transfers, or gifts are also deductible for estate and gift purposes, provided they meet the applicable provisions of Sections 2055, 2106, and 2522 of the Internal Revenue Code. MUFON is a Texas nonprofit corporation.

The *MUFON UFO Journal* is published monthly by the Mutual UFO Network, Inc., Morrison, CO. Periodical postage paid at Versailles, MO.

Individual Membership: \$45/year U.S., \$55 outside the U.S.

Family members: \$10 per person additional

Student (18 years and under): \$35 U.S. and \$45 outside the U.S.

Donor: \$100/year. Professional: \$250/year. Patron: \$500/year

Benefactor (Lifetime Member): \$1,000

First class Journal delivery (in envelopes) U.S. and Canada only: \$12/year additional

Air Mail Journal delivery to all other countries outside the United States: \$35/year additional

Postmaster: Send form 3579 to advise change of address to: *MUFON UFO Journal*, P.O. Box 369, Morrison, CO 80465-0369

MUFON's mission is the scientific study of UFOs for the benefit of humanity through investigation, research, & education.

The answer to a 53-year-old mystery or a hoax?

“Dive company” releases scans alleged to be missing Kinross F-89

By Dwight Connelly

Journal editor

The recent release of alleged underwater sonar scans of an F-89C Air Force jet which disappeared over Lake Superior in 1953 after “merging” with an unknown object has raised more questions than answers.

While the comments and photo scans released by “The Great Lakes Dive Company” are intriguing, there is no evidence that they are legitimate.

An alleged “mystery object” 212.5 feet from the aircraft which has damage reportedly matching damage to the aircraft seems too convenient.

The plane and object scenario also does not match the standard account of the incident, although most of this is based on Air Force documents.

In addition, even the dive company admits that the condition of the nearly intact plane is hard to explain.

Efforts by MUFON to verify that the dive company is an actual business have proved fruitless thus far, and the fact that the company is apparently planning to produce and sell a “documentary” also raises questions as to what the company’s motives are.

The investigation is continuing as this issue of the Journal goes to press.

In attempting to provide readers with the best information available at this time, various sources have been used.

MUFON Field Investigator David J. Watson has spent many hours on this case, as has Incoming MUFON Director James Carrion, who has been in frequent contact with the dive company.

Another primary source is Gord Heath of UFO*BC, who has studied this case for many years.

Also utilized, of course, has been information provided by the “Great Lakes Dive Company.”

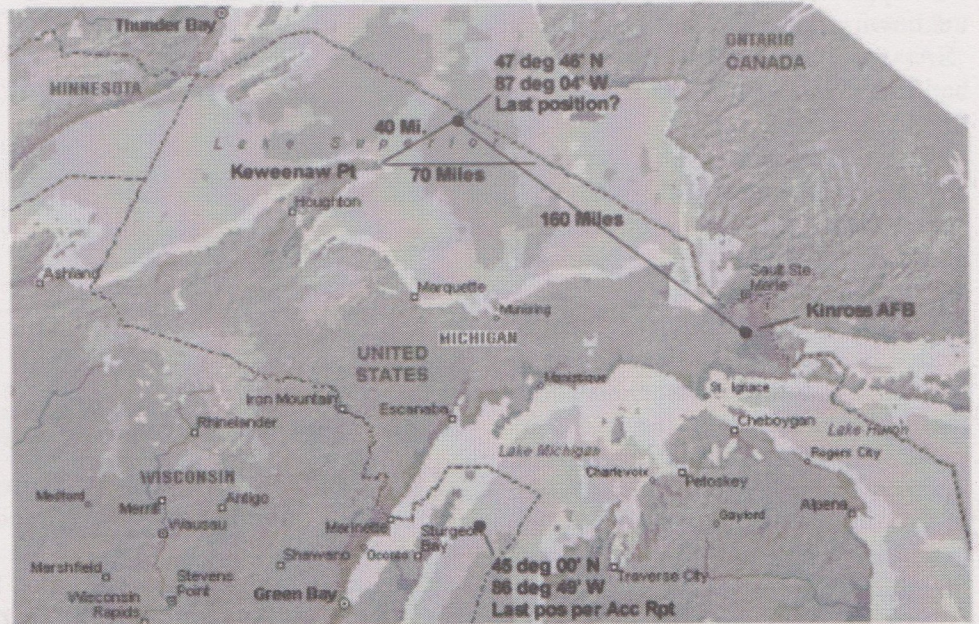

The locale: Lake Superior, near the U.S.-Canadian border. Thanks to ufodigest.com.

A deadly encounter

By David J. Watson

MUFON Field Investigator

As the “Cold War” began heating up in the early 1950’s, the U.S. Department of Defense identified the shipping locks at Sault Ste Marie as a potential target for Russian bombers.

The United States Air Force was tasked with defending the Sault Ste Marie Locks at any cost. That mission fell, primarily, to the aircraft and aircrews at Kinross Air Force Base, located just 20 miles south of Sault Ste Marie.

Shortly after 18:00 (EST) on Nov. 23, 1953, radar operators at Kinross Air Force Base reported an unknown target on radar moving toward the shipping locks at Sault Ste Marie, Michigan.

The radar target, which was assigned the designation A-27-T, had been picked up by Pillow, one of the three Ground Control Intercept (GCI) stations involved in this incident.

The other two were Naples and Horsefly. Pillow was located near the tip of the Keweenaw Peninsula in northwest Michigan on Lake Superior.

The unidentified radar target was believed to be VC-912 (a Canadian military flight), but because the aircraft was supposedly off its flight plan course by about 30 miles, it was classified as an “unknown.”

This radar target was over the east-central portion of northern Lake Superior, heading east toward Sault Ste Marie. Word was received from Naples

that Horsefly wanted a correlation check on the track of the unknown.

At 18:17 (EST), Naples scrambled the alert aircraft (F-89C 51-5853A) from Kinross AFB, 20 miles south of Sault Saint Marie, with Lts. Felix Moncla and Robert Wilson as crew.

The F-89C "Scorpion" Interceptor, call sign "Avenger Red," was tasked with approaching and identifying the unknown radar target.

At the time of take-off, the F-89C had sufficient fuel for 105 minutes of flight.

The aircraft was given a vector of 300 degrees (magnetic) at 30,000 feet. When the plane became airborne at 18:22 (EST), the pilot gave Naples a call on Channel 10 (UHF-2).

Because their reception of Avenger Red was weak, Naples attempted to pass control to Pillow at about 18:35 (EST).

At that time, Pillow could read Avenger Red only very faintly. Checks of the communications systems at Pillow were made with no apparent malfunction of the equipment.

At 18:41 (EST), control of Avenger Red was passed to Pillow, although reception continued to be poor. Avenger Red, however, reported it was reading Pillow "4x4" (clearly).

Avenger Red was directed to switch to Channel 12 (UHF-1). It was found that reception of Avenger Red's transmissions were no better, so communications were returned to Channel 10.

About 18:45 (EST), Avenger Red asked if the intercept should be discontinued because of the weak UHF reception at Pillow. The pilot was informed that the continuance of the mission was up to his discretion. Lt. Moncla advised that pilot discretion was approved, and that the mission would, for the time being, continue.

At about 18:46 (EST), Avenger Red was given a port turn to 270 degrees (magnetic), and directed to descend to 7,000 feet. When Avenger Red answered with "steady on 270 degrees," he came in loud and clear at Pillow, and was so informed.

Shortly thereafter, a clock and range report was given to the pilot, along with

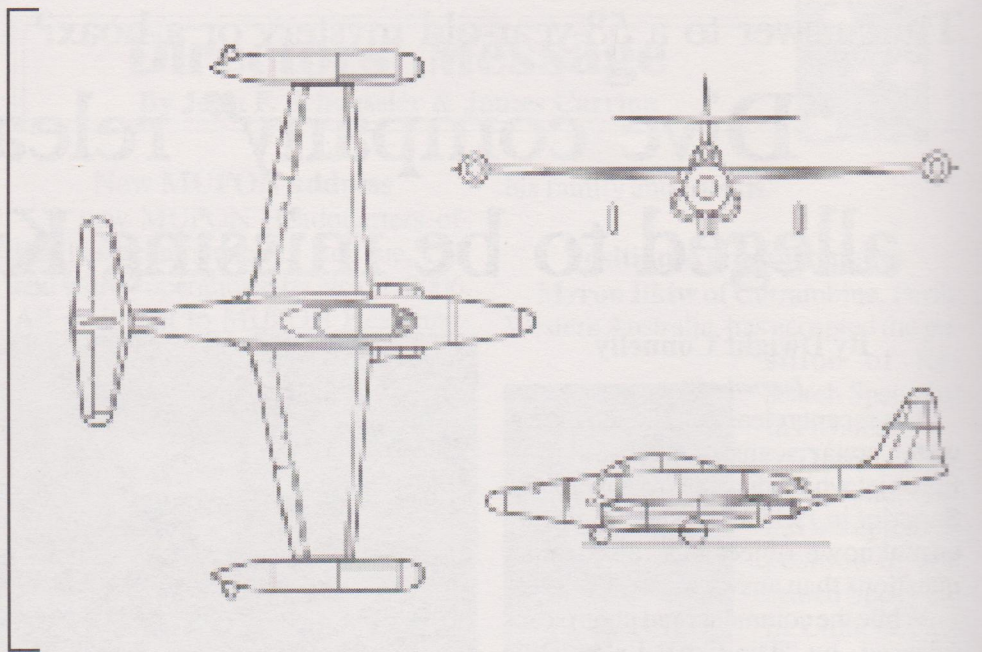

Cryden Flight Research Center February 1998
F-89 8 view

The aircraft involved in the Kinross Incident, F-89C-51-5853A, was the 162nd aircraft of a total of 164 "C" model F-89s built. The model was designated F-89C-40-NO.

The F-89 "Scorpion" was designed from a 1948 USAF specification for a high altitude, high performance, all weather jet fighter. The first F-89C flew on Sept. 18, 1951, and incorporated most of the changes that had been made to the earlier "A" and "B" models.

The "C" model was equipped with external fuel tanks on its wingtips, and a wingtip stabilizer which reduced the effects of aero-elasticity wherein the wing tended to twist during high G-force maneuvers. The F-89C's were plagued with both engine and structural problems, necessitating modifications after production. For example, a total of 194 F-89 "Scorpions" were eventually returned to the manufacturer for installation of a stronger wing.

The F-89C-40-NO was equipped with two Allison J33-A-33A jet engines producing 5,600 lb.s.t. (7,400 lb.s.t. with afterburner). The aircraft had a maximum speed of 650 miles per hour at sea level.

The F-89C had an initial climb rate of 12,300 feet per minute with a service ceiling of 50,500 feet. Its maximum range was 905 miles. It had a wingspan of 56 feet, was 53 feet 5 inches in length, and was 17 feet 6 inches in height.

It was armed with six 20 mm cannon in the nose. Underwing racks could carry 16 five-inch rockets or 3,200 lbs. of bombs.

the unknown's track and altitude. This information was acknowledged, and Moncla informed Pillow that he was still descending through 25,000 feet (received at approximately 18:49 EST).

About this point, Avenger Red was informed that he might encounter icing conditions at the unknown's altitude of 7,000 feet, such information relayed from Horsefly. This transmission was

acknowledged by Avenger Red.

Avenger Red then asked Pillow for "pigeons to home plate." This is a code for a pilot requesting a vector and range back to his base.

This is done sometimes so that the pilot has that information in case of a problem, and the pilot knows immediately where to turn to return home. He is not requesting permission to return

The crew of Avenger Red

The aircraft involved in the Kinross Incident (F-89C-40-NO S/N: 51-5853A) carried a crew of two. The pilot was 1st Lt. Felix E. Moncla, Jr., 27, who had logged 811 hours as a pilot in the Air Force. 121:40 (Hrs:Min) were logged as the pilot of an F-89 "Scorpion," including 101 hours of instrument flight time and 91:50 (Hrs:Min) at the controls of an F-89 at night. The radar operator/observer was 22-year-old 2nd Lt. Robert L. Wilson, who had logged 206:00 (Hrs:Min) in the back seat of an F-89, with 11 ½ of those hours at night.



1st Lt. Moncla



2nd Lt. Wilson

Red. Naples' attempts to contact the fighter were unsuccessful as well.

At the direction of Horsefly, two additional fighters were scrambled from Kinross AFB. Avenger Purple was an F89-C piloted by 2nd Lt. Howard R. Nordeck. Avenger Black was an F-89C piloted by Lt. William Mingenbach.

At Naples' direction, Avenger Black gave several calls to Avenger Red with the

to base.

The pilot was given "pigeons" as 150 degrees, 125 miles. The pilot acknowledged the transmission.

At approximately 18:51 (EST), Avenger Red was given a starboard (right) turn to 020 degrees (magnetic), which was the "cut-off" vector. At 18:52 (EST) Avenger Red was advised that the unknown was at his 11:00 position, 10 miles distance.

This was acknowledged by Moncla. Another "clock and range" report was given to the pilot, along with information that the unknown was moving from port to starboard (left to right).

Avenger Red did not acknowledge that transmission. It was noted in depositions filed with the USAF that the closer Avenger Red got to the unknown, the more the pilot's transmissions were hampered by static.

Just before the unknown target and Avenger Red merged on the screen, he was informed by Pillow that they would be set up for another pass on the unknown if he had not received a contact.

When no answer was received from the pilot of Avenger Red, it was assumed by controllers that Avenger Red's radar operator, 2nd Lt Robert Wilson, had established contact with the unknown and had taken over the intercept.

Had such been the case, the radar operator would likely have been keep-

ing the pilot very busy—too busy to acknowledge transmissions from Pillow.

When there was no separation of targets on the radar after the fighter had merged with the unknown, it was assumed briefly that Avenger Red was flying formation with the unknown.

However, as the two radar images merged on the scope, the IFF transmission from Avenger Red had disappeared. IFF is a transmission which identifies the aircraft as a "friendly aircraft." (IFF = Identification - Friend or Foe).

[The IFF system in 1953 was still in its development stage, and the older systems received codes from aircraft that weren't always processed correctly. By 1997 a new system had an improved reliability. Information as to whether the targeted Canadian military aircraft used IFF in 1953 is not known. Civilian airliners began to use IFF in the 1990's.]

It should be noted that the aircraft had been painting a radar return in addition to the IFF return before the IFF disappeared following the merger of the two radar images. After the radar images merged, Avenger Red's IFF was no longer received.

Every few seconds, however, an attempt was made by Pillow to contact Avenger Red. When no contact could be established, Naples was contacted and advised to try contacting Avenger

hope that communications could be established between the two aircraft.

When all attempts to contact Avenger Red proved futile, Avenger Black and Avenger Purple were vectored back to base by Naples.

In a strange twist, however, Lt. Mingenbach reported, and later testified, that he believed he heard a radio transmission from the pilot of the missing plane, Lt. Moncla, about 40 minutes after the F-89 disappeared from radar:

"At about 1935, heading 330, altitude 25,000, my R.O. [backseat radar operator] and I both believe we heard a short transmission from Avenger Red, recognizable as his voice, for about five seconds on channel 10. He seemed to be in the middle of a sentence when his transmission broke through, and therefore meaning was unintelligible."

Lt. Mingenbach was quite familiar with the voice of Lt. Moncla, who had a distinctive southern drawl.

Capt. William Bridges, who was the OIC (Officer In Charge) of the 433rd Fighter Interceptor Squadron Alert Detachment at Kinross, was made aware of the incident. At 20:07 (Local), the time when the aircraft would have run out of fuel, he notified Kinross Base Operations of an "overdue" aircraft. He also notified the Kinross AFB Commanding Officer.

At 21:30 (Local), the Kinross AFB

Commander suggested that Capt. Bridges fly to the area of the last contact.

Capt. Bridges took off and proceeded under GCI control to a point 75 nautical miles northwest of Kinross AFB, where he was forced to return because of snow showers, low ceilings, and loss of radar and radio contact.

When it became certain that the fighter was down, an extensive search operation was put into motion.

The weather conditions

The weather conditions existing over eastern Lake Superior at the time the contact was lost with the missing F-89, was forecast to be the following:

A general solid deck of Stratocumulus base from 2,000 to 3,000 feet with tops at 6,000 to 7,000 feet. There was a broken Altostratus layer extending from a base of 10,000 feet to 14 to 15,000 feet.

Visibility was generally 10 to 12 miles, falling to 1 to 2 miles in areas of isolated show showers. The freezing level was at the surface to the west, rising to 800-1,000 feet in the east.

Analysis of the Sault Ste Marie Radio Sonde Run for 21:00 Zulu (16:00 EST) indicates that moderate to heavy icing could occur from the cloud base to 7,000 feet.

The air was quite stable, and rime ice should have predominated. No turbulence or other hazard would have been encountered. The winds were light south-easterly at the surface, shifting to west aloft.

The Canadian aircraft

Following is the transcript of the deposition provided by Capt. David C. Collins which was added to the USAF Aircraft Accident Report by Capt. Collins, the Investigating Officer.

"I talked to the pilot of the aircraft which was being intercepted by the F-89 #51-5853A at the time of the disappearance of the F-89. The aircraft being intercepted was a Royal Canadian Air Force Dakota (C-47) on a flight from Winnipeg to Sudberry, Canada.

"The pilot stated that the weather at the approximate last known position of

the F-89 was an undercast with tops at 5,000 feet. There was a scattered condition at 10,000 feet, and above that the ceiling and visibility were unlimited.

"The pilot stated that he was flying at 7,000 feet in the clear, and visibility was unlimited. He stated that he had been in clouds during the earlier portion of his flight, and that he had encountered moderate rime icing in the clouds."

"The pilot stated that he did not know he was being intercepted, and had not seen or heard of the F-89. He stated that he heard no radio transmission which could have emanated from the F-89.

"The pilot could offer no further information to throw any light on the investigation."

Comments On this deposition

I have examined all the depositions filed with this accident investigation. Every one of them is filled with names, ranks, service numbers, and service affiliations except this one!

The RCAF pilot is not identified. Ironically, the mystery RCAF pilot reports flying in conditions in which he would have been easily seen and recognized by Avenger Red.

Two USAF GCI stations reported that they attempted to contact the unknown on both U.S. and RCAF radio frequencies. This statement clearly was added to the USAF Investigation Report to cloud the truth of what really happened to Avenger Red.

When this deposition was added to the USAF Aircraft Accident Report, that report lost all credibility.

Following is a copy of a letter from the Royal Canadian Air Force (RCAF) in reference to the Kinross Incident:

"24 June, 1963

"Dear Mr. Almquist,

"In reply to your letter of April 27, 1963, after extensive checking by this directorate, we have been unable to come up with any information regarding an intercept of a RCAF C-47 by a USAF F-89 on Nov. 23, 1953.

"Any further information on this subject would have to come from the USAF, as they were the agency controlling their aircraft. As you stated,

the C-47 was traveling on a flight plan taking it over Canadian territory. This alone would seem to make such an intercept unlikely. Thank you for your interest in the RCAF."

-W. B. Totman, Squadron Leader Wreckage reportedly found

A spokesman for the "Great Lakes Dive Company," "Adam Jimenez," recently released sonar scans and commentary stating that the missing F-89 was located in 2005.

He said they had just successfully completed testing their new Wide Trajectory Side Scan Sonar in Lake Huron, and had planned to put the new sonar ("Sharc2") to the ultimate test.

The team settled on a plan to search for the remains of the *Cerisoles* and its sister ship, the *Inkermann*, a pair of French minesweepers lost in Lake Superior.

Then, he says, an unexpected glitch in the system shut down operations for a period of time. Since the search area for the minesweepers was quite large, it was decided that in the time remaining in the 2005 season to take a run where the F-89 "Scorpion" had disappeared.

On the fifth day in the water with the "Sharc2" sonar system, the computer reportedly returned some "amazing images."

On the first pass, the resolution was set to low, to maximize range, but even at low resolution the shape of an aircraft was "unmistakable," according to Jimenez.

They were allegedly able to determine that the port (left) side wing and the right side horizontal stabilizer had been sheared away. The other wing had become embedded in drift silt, or plowed into the lake bed.

The second scan (from the opposite direction) was reportedly done at high resolution. From this scan, the team reportedly determined that both the wing and the nose had been "plowed" into the lake bed. The team also allegedly concluded that the canopy and fuselage are both intact.

Jimenez says, "We have confirmed the identity of the F-89 using several

techniques.

“First, the general design of the aircraft is a complete match. Our scan shows an upswept tail section which is a design characteristic of only the F-89 [hence the model name “Scorpion”].

Second, this aircraft has a wing pod, and the canopy location is a match.”

He told MUFON Incoming Director James Carrion that when they lowered a Remote Operating Vehicle (ROV), the correct tail numbers for the plane were observed, and “there were no other F-89s or similar aircraft lost over the middle of Lake Superior.”

However, no scan showing the tail numbers has been provided by the company, and Jimenez told ufologist Richard Hall that the company had not yet found any positive identification, such as a serial number.

The next discovery, said Jimenez, was an anomalous object slightly more than 200 feet from the aircraft.

“We didn’t notice the object when we discovered the plane,” he says, “but when we did a detailed search surrounding the aircraft trying to locate the missing wing, a portion of the side scan came back distorted in an area near the wreckage of the F-89.

“We focused on this area and tried to scan it with the Sharc2, but had no luck. It was still distorted.

“One of our team recalled that F-89’s were known to carry a nuclear weapon called a “Genie” rocket [missile]. Although this was not deployed until later versions of the F-89, we didn’t know if some sort of covert testing may have happened on earlier versions, and thought this could be what was causing our equipment issues.

“Returning with a Geiger counter a day later, we put the theory to the test, and no radiation levels were detected.”

The Geiger counter, Jimenez told Carrion, was a DX-1 hand held model, which was placed in a sealed chamber within the ROV, with the speaker output patched into the audio input of the digital camera on the ROV.

“Initially, the object appeared to be large and almost tear-drop in shape,” Jimenez says. “It was only 212.5 feet from the F89. But the scan showed

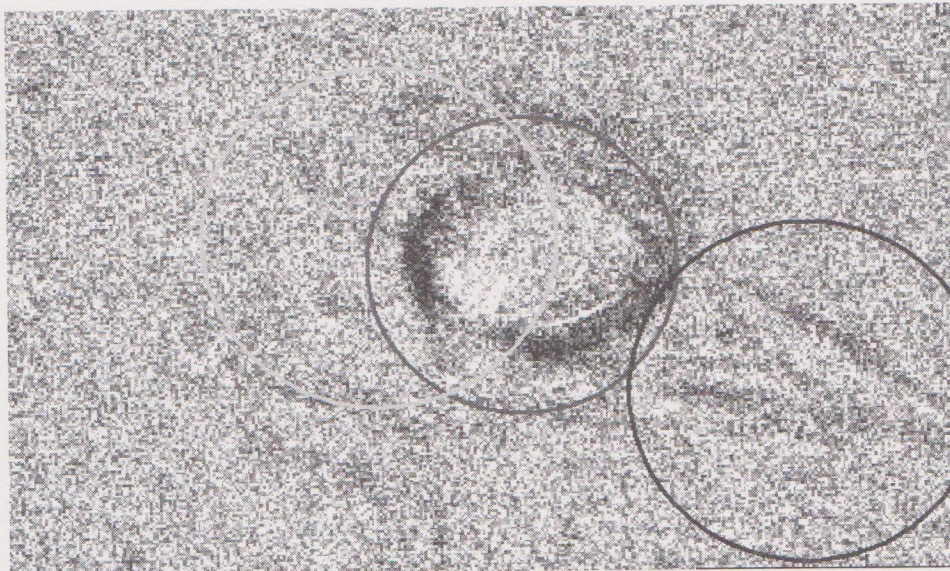

This image of what is reportedly the mystery object was released by the dive company. The circles emphasize the object and a groove in the lake bottom supposedly made by the object.

something very interesting—a plow mark trailing behind the object, as if it had crashed.

“This plow mark caused us to focus our immediate attention on the object, and we lowered our ROV to it and confirmed that the mystery object was metallic, and also had a strike mark that matched the missing wing hole on the F-89C Scorpion. It is possible that the missing wing may be underneath the mystery object.”

According to Jimenez, “The section of the object that is visible above the sand is approximately 15 feet long by 8.4 feet wide, and, as previously mentioned, has a tear-drop shape. But this may be just the tip of the iceberg, with the majority of the craft hidden below tons of sand.

“Our conclusion is that it would be highly coincidental for this object containing a suspicious strike mark and plowed near the F-89 to not have anything to do with the crash,” he said.

However, Jimenez acknowledged that the scene at the bottom of the lake is contradictory.

“We are a little baffled by the actual physics of the crash,” he admits. “If you can imagine a plane colliding with another object and a wing shearing away, it seems as though the plane would spin out of control and disintegrate on the

surface of the lake.

“Also,” he adds, “the plane is in deep water, yet appears to be plowed into the lake bed. How could the plane—or the object for that matter—maintain enough power to accomplish this.

“I’m telling you this because we don’t have all of the answers to this mystery yet. Our best guess is that the collision took place at or near sea level at relatively low speed. This scenario would preserve most of the aircraft structure, but still doesn’t account for the plowing.

“We have not been able to confirm that the bodies of the two pilots are inside the aircraft,” explained Jimenez, “as we were unable to see inside [using the ROV] due to silt and the translucent nature of the canopy. One would assume the crew is still inside.”

The team claims to have conducted a total of 28 passes on the aircraft and the surrounding area (10 square miles), but was unable to find any trace of the missing wing or tail section.

After what was described as a very productive 2005 season, including the alleged discoveries made possible by the use of the ROV, the 2006 dive season produced nothing.

“2006 began as an ambitious project season for us,” says Jimenez, “and we were looking forward to further work

at the F-89 site. Then we received some bad news. The Canadian government refused to allow us to use our ROV at the wreck site without first providing them the GPS coordinates of the site and allowing either a Coast Guard escort or government official to accompany the expedition.”

However, a check by Carrion with the Ontario Receiver of Wrecks (Mr. Putt) reveals that permission to use an ROV is not required, although any vessel working in Canadian waters is required to have a work permit.

The dive company had used the ROV on the initial discovery in 2005 because the risk existed that they might not be able to return to the site, according to Jimenez.

He added that weather issues in 2005 prevented the company from thoroughly exploring the site.

“We don’t want to give up the site, especially because of the object and its potentially huge significance,” SAID JIMENEZ, “but we need to stay on the good side of the Canadians due to our Gunilda project, which involves a lot of other contributors.

“So as it stands now, we have just issued a letter to the Canadian government essentially abandoning work on the F-89 site this season [2006].”

The Ontario Receiver of Wrecks, however, indicates no knowledge of any such letter.

“We will have to wait until next year and the new dive season for more answers about this mysterious object and the fate of the crew of the F-89,” said Jimenez.

In response to an inquiry by Carrion, the dive company said that none of the relatives of the F-89 crew have contacted the dive company.

Carrion was also told that a documentary of the project is being considered.

He asked if any agency besides the Canadian government had requested coordinates for the site, and was told that no other agency had requested such information.

MUFON is continuing its investigation of the alleged wreckage site as the *Journal* goes to press.

The Kinross incident

Posing some questions

By Gord Heath

[Following are edited excerpts from a full report at UFOBC.com, used with permission. Heath has been studying this incident for several years, and wrote most of this report before the announcement that the missing plane has allegedly been found.]

What caused the initial alert?

One unanswered question that still seems clouded in mystery is what caused the alert at Kinross which resulted in the F-89’s mission over Lake Superior?

There are three main possibilities which are referenced in the historical accounts.

According to the report documenting the USAF Official Accident Board’s Investigation, the alert was caused by an RCAF C-47 flying 30 miles off course from its flight plan in an easterly direction over Lake Superior.

A second explanation is that the cause of the alert was a regularly-scheduled Canadian DC-3 airliner which was on course, but its flight plan had not been received at Kinross.

The third explanation is that the cause of the alert was not a civilian DC-3 or military RCAF C-47, but rather a UFO that was never identified.

Cause 1: off course RCAF C-47

The “official” cause of the alert is documented in the USAF Official Accident Board’s report prepared in December, 1953, in the statement provided by 2nd Lt. Douglas A. Stuart.

At the time of the alert, he was monitoring the intercept from “Pillow” GCI, a USAF radar station near the tip of the Keweenaw Peninsula, which juts out into the middle of Lake Superior from Michigan.

Lt. Stuart opens his statement with the following explanation for the alert:

“When A-27-T was picked up by Pillow (P-16) it was believed to be VC-912, but because the aircraft was off

the flight plan course by about 30 miles, it was classified as “Unknown.” Word was received from Naples (P-66) that Horsefly wanted a correlation check on the track.”

The aircraft is more specifically referenced elsewhere in the official accident investigation report, in Form 14 No. 52-11-23-5, paragraph 6:

“The unknown aircraft being intercepted was a Royal Canadian Air Force Dakota (C-47), Serial No. VC-912, flying from Winnipeg to Sudberry, Canada. At the time of the interception it was crossing Northern Lake Superior from west to east at 7,000 feet. This flight was approximately 30 miles south of the intended flight path.”

Over the past decades, there have been a few statements made by the RCAF with respect to the alleged intercept of the “off-course RCAF C-47.”

One example of written correspondence concerning the alleged encounter is a letter from a flight lieutenant writing on behalf of the Chief of the Air Staff at the Canadian Department of National Defence in Ottawa in April, 1961, to a Jon Mikulich of Milwaukee, WI:

“Thank you for your letter of April 4 requesting information regarding an ‘Unidentified Flying Object’ on November 23, 1953.

“A check of Royal Canadian Air Force files has revealed no report of an incident involving an RCAF aircraft in the Lake Superior area on the above date.

“May we point out that if an aircraft fails to answer a radio request to identify itself it would normally be assumed that its radios are not functioning, or that the aircraft has suffered a complete electrical failure.”

The correspondence does not state that there was no flight of an RCAF aircraft over the lake that night. It merely states that there is no record of an incident in RCAF files for that date.

The letter does cast some doubt on the necessity of an intercept under conditions where the aircraft fails to respond to a radio request to identify itself.

This does raise a question of why there is no mention of any attempts made to contact the unknown to identify itself, particularly if it was already suspected that the aircraft was an RCAF aircraft, allegedly flying off course.

[As previously noted, MUFON investigator David Watson found that "two USAF GCI stations reported that they attempted to contact the unknown on both U.S. and RCAF radio frequencies." However, he feels that this was added to the original report.]

A member of NICAP also sent a letter to the RCAF in 1963 requesting information on the alleged intercept. The Acting Director of Public Relations for the RCAF stated in his letter written June 24, 1961:

"... we have been unable to come up with any information regarding an intercept of an RCAF C-47 by a USAF F-89 on November 23, 1953. Any further information on this subject would have to come from the USAF, as they were the agency controlling their aircraft. Also as you stated, the C-47 was traveling on a flight plan taking it over Canadian territory. This alone would seem to make such an intercept unlikely."

This correspondence is a more specific denial that the intercept incident involved the RCAF C-47, although it does suggest that an RCAF C-47 was on a flight over Lake Superior the night of the F-89's disappearance.

Following these clues, I decided it was important to obtain more specific information concerning the flight made by the C-47 on Nov. 23, 1953.

The Accident Investigation Report states that this C-47 was identified as having serial no. VC-912. I was to discover that this is not the manufacturer's serial number for the aircraft, but was rather the code assigned for identification purposes of aircraft.

After some research, I was able to determine that this aircraft was flown

by the RCAF 412 Transport Squadron based in Rockcliffe, Ontario, in 1953.

Through an Access for Information request to the Canadian government, I was able to obtain flight records for the 412 squadron for that year. The records are simply a summary of each flight made by the squadron's aircraft.

I was able to locate the closest entry for C47-912. The mission departed on Nov. 21, 1953, from CFB Rockcliffe. Its purpose seems to be to convey passengers "Mr. Merrifield and party."



Gord Heath

The flight stopped overnight at CFB Uplands before departing for other airfields on Nov. 22. The plane did not reach Winnipeg until 1220 EST. It departed Winnipeg at 15:55 EST, reaching Rockcliffe at 2210 EST, about 3 hours after the F-89 was lost over the lake.

Through the flight records, I was able to find that the crew on this flight was F/O Fosberg, F/L Edwards, F/O Penhold, F/L Scharf, and Sgt. Lynch.

This turned out to be a lucky break, as my search of telephone directories on the Internet revealed that there were not very many Fosbergs living in Canada. I mailed a letter of inquiry to each Fosberg I found.

A few weeks later I received this reply from a Gerald Fosberg, who now lives in Ontario.

"I'm your man! I was at the time indeed serving with the 412 Sqn. At Rockcliffe, doing what I loved best—flying aeroplanes.

"At the time I was a flight Lieutenant, married with our first of three children on the way. Served 28 years and retired in May 1974 as a major. Continued flying Corporate Jets for another twenty years.

"I remember the flight reasonably well, and just checked my log books to confirm the date. It was a night flight. We were probably at 7,000 or 9,000 feet over a solid cloud deck below and absolutely clear sky above.

"Somewhere near Sault Ste. Marie, and north of Kinross AFB, I think a ground station (can't remember whether it was American or Canadian) asked us if we had seen another aircraft's lights in our area.

"I do think I recall them saying at that time that the USAF had scrambled an interceptor and they had lost contact with it. We replied that we had not seen anything.

"A few days later I received a phone call from somebody at Kinross who was carrying out an investigation on a missing aircraft. I could only tell them that we had seen nothing. That was the last I ever heard of the incident.

"Sorry! However, if the mystery is ever solved, please, would you let me know the answer."

Fosberg's letter confirmed that he had been radioed by GCI after the F-89 went missing. They had asked him if he had seen the F-89, and he replied he had not.

This does partially confirm some details in the Accident Report, as it states the following in paragraph 6 of Form 14 No. 53-11-23-5 about the C-47:

"The pilot stated that he was on top of a 5,000 foot undercast and at the approximate time of the interception he was flying in the clear and visibility was unlimited. He also stated he did not know he was being intercepted and that he did not see the F-89."

In further conversations with the pilot, it was not clear that he was aware that the F-89 was allegedly trying to intercept his aircraft, and that the radar return from the F-89 was observed to merge, allegedly with his aircraft just before all contact was lost with the F-89.

In addition, Fosberg was quite clear that there was no possibility that his plane was off course by 30 miles at any time during this flight. He told me that because of the radio navigation system used, he would be quite aware if his plane veered off the flight plan.

"I asked him if he could recall the flight path they took that night. He indicated to me that his flight took him directly over Fort William airport (now

Thunder Bay) and Sault Ste. Marie.

To the best of his recollection, he thought the flight path over the lake was a straight path from Fort William to Sault Ste. Marie.

Analyzing what was revealed by Fosberg, it seems to me that the USAF allegation that the C-47 was 30 miles off course is most probably false. Examination of this evidence suggests the following possibilities regarding the official explanation:

One possibility is that the C47 was never off course, but that the order for the alert was made because USAF officers at Horsefly GCI wanted to perform a mock intercept of the RCAF craft as it provided an opportunity to test interceptor response to a potential threat.

A second possibility is that the C47 was off course, and that the pilot simply was unaware of this or had forgotten about this.

A third possibility is that the C47 was not the cause of the alert, but was merely the most convenient scapegoat for a failed intercept attempt for another aircraft or unknown.

Cause 2: Off-Course Canadian DC-3 airliner

If the cause of the alert was not the C47, perhaps it was another aircraft in the air that night. There is no mention of any other aircraft in the USAF Accident Report, but there is mention of a civilian DC-3 airliner in other sources.

Before delving further into this possibility, it should be pointed out that the Douglas Dakota C-47 was a military version of the Douglas DC-3 which was widely used by commercial airlines as a passenger carrier in the 1950s.

I was able to track down some members of the 433rd Fighter Interceptor Squadron. One of them, Dave Eby, a pilot, responded to my email enquiry about the incident:

“Your request for info about Moncla and Wilson was forwarded to me. I was at Kinross the night they didn’t return. The 433rd had 4 a/c and 8 crews were pulling alert while the sqdn. based there was at Yuma for gunnery training.

“As I recall, they were scrambled about 6 P.M., just after sunset. The

“unknown” was a regularly scheduled airliner. The flight plan didn’t get to the G.C.I. site. The target was near the center of the lake.”

Note that in Dave’s recollection of the incident, the unknown was a “regularly scheduled airliner.” This certainly cannot be the same as the RCAF transport VC-912 which flew for the 412 squadron, as the RCAF is not an airline, and its flights were not “regularly scheduled.”

Dave goes on to explain that “the flight plan didn’t get to the G.C.I. site.” I take this to mean that the alert was called because even though the flight was regularly scheduled, the GCI operators didn’t have the flight plan in front of them for that particular flight.

My attempts to reconcile the differing stories were complicated by information I received from another source connected with the incident. In the fall of 2002, I was given the name of a man, Forrest Parham, who had served in the Air Force and knew Lt. Moncla.

Parham was a member of the accident investigation board which produced the report for the US Air Force.

During the course of our conversation, Forrest told me that the unidentified was “an airliner” which had drifted south over the lake (Lake Superior). He also indicated that there was no flight plan, or that the flight plan had not reached GCI.

[This is interesting, coming from a member of the accident investigation board, since the official Air Force report makes no mention of an airliner, referring only to the Canadian military aircraft.]

There are several possible explanations for the role of the Canadian DC-3 airliner as it recurs in these accounts of the event. My theory is that there was a Canadian DC-3 airliner flying into Sault Ste. Marie at the time of the incident.

What merged on radar?

A second unanswered question is what was it that the F-89 merged with on radar before contact was lost with the F-89?

According to the report documenting the USAF Official Accident Board’s Investigation, the F-89’s radar

return was observed to merge with the return from the RCAF C-47 before contact was lost with the F-89.

If the statement made by Lt. Stuart contains a factual error about the purpose of the intercept mission, I believe this quite possibly indicates the whole investigation report might be a deliberate fabrication to cover up something more sinister, such as a UFO pursuit which ended with the disappearance of the F-89 and its crew.

This account of the disappearance of the F-89 is contained within UFO investigator Maj. Donald Keyhoe’s book *The Flying Saucer Conspiracy*.

During his investigation of the Kinross F-89 disappearance, Keyhoe made several telephone calls to First Lt. Robert C. White, a Public Information Officer (PIO), at the Pentagon’s Air Force Press Desk.

When Keyhoe asked Lt. White about the official statement made by Truax Field that the F-89 had merged with an object 70 miles off Keweenaw Point, Lt. White was reported as replying, “That’s not true.”

When Keyhoe asked if the AP story was wrong, White is reported to have replied:

“Well ... no. Truax made the statement. But the ‘merging’ part was a mistake. That second blip was from some object actually miles from the F-89.”

When Keyhoe asked why the GCI had stated they had merged, Lt White responded, “They just read the scope wrong.”

It is important to note that the merging of the returns on the scope does not necessarily imply actual physical contact.

Firstly, the F-89 could be flying at a different altitude and could pass above or below its target. Secondly the resolution of the radar screen is such that the returns are displayed larger than actual scale size, otherwise, the returns would be impossible to represent on the screen.

However, it is quite a leap to suggest that the GCI operators would state the returns had merged when the targets were “miles apart.”

If the equipment and operators were that unreliable, it would be impossible for the radar system to be of much practical use in guiding the pilots to intercept an unknown.

Lt. White's statement may indicate that Air Force officials at the Pentagon were worried about the implications of an intercept with a UFO which resulted in the disappearance of their aircraft.

Whether the disappearance was from the capture of the aircraft, or a collision and crash of the F-89, it would imply an inability to prevent penetration of the air space by an intruder.

It might also suggest a hostile intent by the unknown intruders flying the UFOs.

The Air Force was already worried about public alarm over the possibility that the UFOs might be vehicles from a technologically superior civilization from another planet. Clearly, they would not want the public to be alarmed by awareness that the USAF was vulnerable in its sorties of UFOs in US air space.

It is highly unlikely that the GCI operators guided the F-89 more than 150 miles out over Lake Superior in pursuit of a flock of birds or the reflection of the F-89 from an atmospheric layer.

If the unknown aircraft was never identified, this suggests two possibilities:

The USAF and RCAF were never able to identify the "aircraft" because they lost radar contact with it sometime on its journey before it landed.

Or the USAF and RCAF were never able to identify the "aircraft" because it was not an aircraft that needed to land at an airport or air strip.

This does once again suggest a possibility that the unknown might have been a craft of unknown origin and technology—a UFO by definition, and possibly a vehicle of extraterrestrial origin.

What happened to the F-89 after radar contact was lost?

The report that was prepared by the Official Accident Investigation Board concluded on the fate of the F-89:

"The aircraft probably crashed in the Canadian waters of Lake Superior just

prior to or at the time of interception."

It was probably not possible for the investigation board to reach a more definitive conclusion, due to the simple fact that no trace of the F-89 or its crew was found during the search of the lake and shoreline.

Given that the F-89's IFF signal was lost at the time the radar return from the F-89 was observed to merge with the unidentified aircraft, it does seem the most likely reason for the loss of both signals and the loss of radio communications would be that the F-89 crashed into the lake at this moment.

If the F-89 had crashed into the lake, it would probably have broken up with little intact wreckage. Only small pieces of floatable debris would remain on the surface along with fuel, oil and hydraulic fluid slicks.

The fuel would soon evaporate and perhaps the oil slick would break up due to the action of waves and surface currents. Visibility was impaired by poor weather during the first day of the search.

Theoretically, it might still be possible to locate metal fragments from the F-89 at the bottom of Lake Superior by using a deep water submersible equipped with side scan sonar imaging to search the lake bed beneath the hypothetical crash site.

Did F-89 crash into brush east of Lake Superior?

Because the last place of contact with the F-89 was in Canadian airspace, the search of Lake Superior was coordinated by the RCAF Eastern Area Rescue Coordination Centre based in Trenton, Ontario. The US search efforts were led by the 49th Air Rescue Squadron from Selfridge AFB near Detroit, MI.

As was often the case in such search efforts, the search teams received many tips during the course of the SAR operation concerning observations submitted by members of the public who thought they may be related to the F-89 disappearance.

One such report was made by an Algoma Central Railway maintenance crew which was operating at Limer, a

short distance east of Wawa, Ontario, on the night of the F-89's disappearance.

The railway workers reported that they had heard a low flying jet followed by the sound of the plane crashing. Originally, investigators dismissed the report because the reported time for the incident was beyond the time the F-89 could have been in the air with its limited fuel supply.

Later, a witness indicated that he was possibly wrong about the time. With coaxing from the father of 2nd Lt. Wilson, the USAF reopened the search. This second search was conducted by the USAF in the spring of 1954.

Is it difficult to assess whether the reports of the jet crash were reliable. If the sound was from the F-89, it would first be necessary to explain how the F-89 could have flown from the middle of Lake Superior to the area of Wawa, Ontario, without being detected by radar.

From the reports I have read about the incident, it seems apparent that it was observed from at least three or four separate USAF radar sites. I have also heard that the incident was possibly observed from at least one Canadian radar installation.

Surely, if the F-89 was still flying after radio and radar contact was lost at 18:55 EST, then some radar reflection of the F-89 should have been observed.

Radar, radio interference?

One interesting detail in the testimony from Lt. Stuart is that the F-89 was intermittently painting a target return on radar. The return from the F-89 was displayed on some sweeps, but was absent on others.

It was also reported that radio communications between the F-89 and GCI were sporadic during parts of the F-89 intercept flight over the lake, and got worse as the aircraft got closer to the unknown target.

Were radar and radio affected by some sort of electromagnetic interference from the unidentified aircraft/UFO, or was this merely caused by the weather front which was advancing over the lake?

It is interesting that no similar radio communications or radar tracking problems were noted for the F-89 search flights piloted by Lt. Mingenbach, Lt. Nordeck, and Capt. Bridges.

The jets piloted by these Air Force officers all flew through the same weather front as Moncla and Wilson flew through earlier that evening.

It is also interesting to note Lt. Mingenbach's testimony regarding the radio transmission he heard about 40 minutes after radar and radio contact with the F-89 had ended. He reported that the transmission sounded like an accidental transmission from F-89 pilot Lt. Moncla.

He recognized Lt. Moncla's voice from his distinctive slow southern drawl. Does Lt. Mingenbach's testimony suggest the possibility that the F-89 did not crash when it was last seen on radar? If so, what could have happened to the plane and crew?

Was F-89 captured by UFO?

The theory that the F-89 was possibly captured by a UFO was proposed in Donald Keyhoe's book *The Flying Saucer Conspiracy*. The basis for this theory can be summarized as follows:

Maj. Keyhoe is awakened by a phone call on the night the F-89 was lost, and told of a rumor at Selfridge Air Force Base that the F-89 was lost after "colliding with a flying saucer."

The USAF provides contradictory explanations for the intercept, suggesting a possible cover-up of the alleged UFO encounter.

An aerial search of Lake Superior and the Lake Superior coastline provides no trace of the F-89 or crew.

To this day, we don't know who it was who phoned Maj. Keyhoe and alerted him about the rumor that an F-89 had been lost after colliding with a flying saucer.

We do know that Selfridge Air Force Base played key roles during the intercept and search efforts. The alert was called by Selfridge, so it is clear they were aware of the real reason for the alert—whatever it was.

It seems apparent that several radar sites in the US were monitoring the flight of the F-89, so there were prob-

ably at least ten or twenty observers of the intercept at the three or four GCI sites.

Most of these observers have kept a low public profile and have opted to remain silent about what they witnessed that night. [But see "Another version" on the following page.]

The contradictions in the USAF accounts of the intercept does suggest that they were conducting a cover-up of the incident.

It would be logical for the USAF to cover up the incident if the loss of the F-89 was related to a pursuit of a UFO.

But are there other potential reasons for a cover-up? One possibility is that some of the contradictions arose out of confusion and poor communication.

Problems with directions

The initial bearing for the F-89 was 300 degrees magnetic. Given magnetic declination of 1 degree 30 seconds west, the actual initial bearing would be 298.30T.

The final bearing provided by GCI to the F-89 was a starboard turn to 20 degrees magnetic (18.30T) at 18:51 EST.

The previous to final turn was a port turn to 270 degrees magnetic (268.30T) at 18:47 EST.

"Pigeons to Home Plate" was requested by the pilot about 18:50 EST. This (I believe) was a request for a return bearing and distance to home base, and was provided by GCI as "150 - 125 miles."

I take this to mean a bearing of 150 degrees magnetic and 125 miles distance on the return vector.

My analysis

The primary source for all of this information, with the exception of the actual final merge coordinates, comes from the statement made by GCI controller Lt. Douglas Stuart.

The final coordinates of the merge location comes from USAF telexes and from the RCAF SAR report.

When this information is transferred to a map, it shows that some information is missing, and some information may be inaccurate or incomplete. I suggest that some of the inaccurate infor-

What happened to the missing appendix in the USAF Accident Report?

This missing appendix is a map of the F-89 and purported flight path for the C-47.

It is suspicious that this appendix was possibly removed, as it possibly contains a falsified accounting of the alleged flight of the C-47 which could be challenged by people who were participants and witnesses to the incident.

If the missing appendix does not contain false flight paths, why would it be the only document to be lost or withheld from this file?

mation may be simple typographical errors.

It is also possible that mistakes were deliberately introduced into the report by USAF authorities to create ambiguity about the actual flight path for the F-89.

The first omission or error relates to the initial vector. If the initial bearing was 300 degrees magnetic, then the pilot had to make an additional starboard turn sometime early in the flight.

Without making this turn, the pilot would never have made it over the Canadian border where the intercept occurred with the bogie.

Alternatively, it is possible that the initial bearing was perhaps 320 or 330 degrees. The initial bearing of 300 degrees is only mentioned once, and therefore it could be a typographical mistake or carefully inserted error.

I think the "Pigeons to Home Plate" bearing and distance measurements are both probably wrong.

If the pilot was only 125 miles from base at 18:50 EST, then the F-89 had to fly a minimum of 38 miles in the final 5 minutes. This is equivalent to a speed of 460 mph.

If the F-89 flew a net distance of 125 miles in the first 28 minutes of the flight, the average net speed (not accounting for turns) for the F-89 would be 268 mph.

It would make more sense for the pilot to be slowing down during the final minutes of the intercept. This is because the pilot was descending and, more importantly, was preparing an intercept with an aircraft whose cruising velocity was about 170 mph (assuming for a minute that the F-89 was actually intercepting a C-47, DC-3, or other propeller-powered aircraft from that period).

Missing F-89 found?

As already explained in a previous article, a group of "Michigan-based divers and engineers, the Great Lakes Dive Company," has announced that they have found the wreck of the F-89 on the bottom of Lake Superior.

The company spokesman also describes an anomalous object just over 200 feet from the aircraft.

Until more information becomes available, however, all we have is a few images which are reported to be from their side scan sonar.

Although the Great Lakes Dive Co. (GLDC) has so far been providing interesting information, there will be lingering doubts on the veracity of this find until it can be further substantiated.

GLDC claims to believe this discovery may imply the F-89 was brought down by a collision with some sort of unknown craft, which may be the mysterious object on the lake bed.

However, they are unable to reconcile this theory with the good structural condition of the F-89.

I believe the discovery, if legitimate, might imply something quite different. It may be possible that the plane was placed on the lake bed by the crew of the craft which perhaps abducted the plane and crew. I think this remains a possibility due to the following:

The F-89 disappeared from radar at an altitude of 7,000 feet. If it collided with a craft at this altitude then the F-89 should still have reflected radar signals as it fell to the lakebed.

If it collided with the object at a lower altitude, we still need to explain why the altitude of the unknown and F-89 was not tracked below 7000 feet.

The port wing and starboard tail

horizontal stabilizer are missing from the plane, and, despite many scans, no evidence of them has so far emerged.

The pilot of the first F-89 into the air in search of the missing F-89, Lt. Mingenbach, believes he heard a radio transmission from the pilot of the missing plane, Lt. Moncla, about 40 minutes after the F-89 disappeared from radar.



Oct. 13—Texas Bigfoot Conference, Jefferson, TX, 877-529-5550, www.texasbigfoot.com.

Oct. 14—Massachusetts MUFON Fall Event, Watertown, MA, featuring Stan Gordon, Greg Berghorn, Mark Petty, and Chris Pittman. www.massmufon.com.

Oct. 28—Mysteries of Space & Sky III, near Annapolis, MD, featuring Don Berliner, Rob/Sue Swiatek, Anna Jamerson, Dr. Charles Emmons, and conference organizer Dr. S. Peter Resta (spr100@aol.com) 410-360-1168 X 8.

Oct. 28—Roswell Halloween Special Venue: Roswell, NM, featuring Eve Lorgen (tentative), David Flynn (not confirmed), Greg Bishop, Adam GoRightly, and William Schnoebelen. www.roswellufoconference.com

Nov. 10-12—UFO Crash Retrieval Conference, Las Vegas, NV, featuring Stanton Friedman, Dr. Michael Salla, Richard Dolan, Paul Schatzkin, Ryan Wood, Michael Lindemann, Peter Merlin, George Knapp, Dr. Robert M. Wood, Nick Redfern, Frank Feschino, Linda Moulton Howe, Dr. Bruce Maccabee, and Matthew E. Thuney; www.ufoconference.com, 720-887-8171.

Nov. 17-20—Crop Circles & Keys to Higher Consciousness, Tempe, AZ, featuring J.J. Hurtak, Russell Targ, William Henry, Jim Marrs, Linda Moulton Howe, Francine Blake, Nancy Talbott, Flordemayo, Philip Gardiner, Bert Janssen, Heather Clewett, & Chet & Kallista Snow. www.chetsnow.com, 928-204-1955.

Dec. 1-3—National UFO Conference, San Diego, CA, 858-523-1068, www.nufoc.org.

Another version

The following testimony regarding Kinross by an individual requesting that his name not be used has been quoted on the Internet and in *Flying Saucer Review*, but the *Journal* has been unable thus far to contact this person:

"...I'd like to fill in the gaps in the UFO "anomoly" incident over Lake Superior in 1953. I was stationed in Battle Creek, Michigan, at a radar AC&W (Air Craft Control and Warning), and was on duty when the incident took place.

"When we were notified of the "bogy" to the north of us, we increased our radar range. We spotted the target, which was stationary, by a bright blip on the screen over the east end of the lake. Two F-89C interceptors were heading west from Kinross AFB.

"One of the F-89's had to abort the flight because of mechanical problems. The pilot aborting asked the other pilot if he wanted to return home or wait for another wingman. He (Moncla) said 'Negative' to both, and continued to intercept.

"I was watching it unfold and was able to monitor the transmissions from the aircraft to his ground controller. The transmission was something like this:

"The first report from the pilot, 'No Joy' (No Contact). On the scope he was closing in on the bogey. As he got closer he announced (slight static), 'I have an eyeball on the target, am going in for a closer look.' (more static) Each time he transmitted, it became more and more unintelligible.

"As his aircraft converged with the target, there came steadier and louder static each time he transmitted until they merged. Then all was silent. From my position the now merged blip started northwest for a short time and then disappeared.

"The strangest thing about the incident was the closer he got to the bogey, the fewer words were heard due to the increase in static. The static was present only when he transmitted. A word here and there was heard. As the targets merged there was a long blast of static. His last transmission???"



FILER'S FILES

By George Filer
Director, MUFON Eastern Region

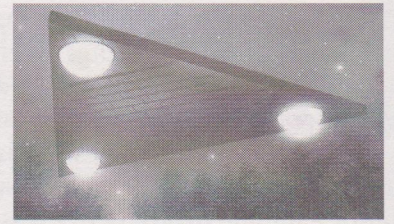

Note: These reports are presented in order to keep readers informed of some of the vast number of sightings being reported. However, these cases have not been officially investigated, unless noted.

UFO lands on Scottish mall?

The Paisley Daily Express reports that the mysterious appearance of a "crop circle" on the roof of Paisley's leading shopping center has led to claims that aliens landed in the town.

The bizarre circle, measuring six meters (18 feet) across, appeared on the flat roof area of the Paisley Center following a series of strange goings-on at the popular mall.

Center manager Andrew MacKinnon said, "This is not a joke. I believe it was a UFO."

The circle, which is grayish in color and has a gold-colored edging, appears to have been burned into the roof's gravel covering.

The appearance followed the simultaneous malfunctioning of office electrical equipment at the center that included blow-outs on a photocopier, a fax, and the vitally important CCTV equipment.

MacKinnon said the roof is a secured area and not accessible to the general public. The manager's theory is that a UFO attempted to make contact with the people of Paisley via the radio equipment located on the roof.

A satellite dish housed near the possible landing area also malfunctioned after the appearance of the circle.

Jamie Lavery, 47, a maintenance engineer, said, "While undertaking some roof maintenance, I briefly saw what appeared to be a brightly-lit flying object." A strange metal-like material was found on the center roof after the appearance of the circle that has been sent for analysis.

Object enters Lake Superior

Lake Superior—On Sunday, Sept. 3, 2006, at or near 11:30 PM, witness E D T, reports: "While sitting outdoors looking across White Fish Bay toward Canada, gazing at the red beacons from many electricity generating windmills on an island in the bay, I suddenly became aware of a brilliant gold-white sphere of light just below the cloud layer to my east.



George Filer

"I was in a lawn chair and had binoculars with me. Seeing this light appear below the overcast, my first thought was of an aircraft with its landing light turned on.

As an airplane watcher I kept my eye on the light, expecting to see and hear an aircraft approach directly toward me. I said nothing to my wife, who was next to me tending our fire.

"I picked up my binoculars for a better view and noticed while watching the light that I was lowering the glasses to keep it in view as the surface of the lake was becoming visible.

"I realized the object was not heading toward me, but instead was in a slow, controlled, steady descent. As it neared the lake's surface, its own brilliance formed a reflection on the water.

"As the object continued its descent, the reflection on the water grew brighter and larger. The object, visible only as a ball of light (which may have had a dark band across the center), lowered itself, and the object and its reflection merged at the surface of the lake and the object was gone from view.

"As I watched the object, it had descended into and below the surface of

the lake. It had taken about a minute.

"Not a ripple or other disturbance appeared on the surface. There was no dark outline of a landed craft.

"There were no sounds. There was never any steady, flashing, or strobing red, green, or white navigation lights as would appear on a conventional air or watercraft.

"I continued to watch, but nothing more was seen, just empty, still water. I eliminated all the mundane, prosaic things to come to mind: conventional aircraft, watercraft, meteors, fireballs, parachute flares, signal flares, balloons, etc.

"This object behaved like none of these things. It took about a minute. I felt I had witnessed something unusual." Thanks to MUFON CMS

Tennessee plane in near miss

Johnson City—Kim Shaffer, director of AUFORC, reports that the FAA has confirmed that a pilot of a regional service airline reported a close encounter with an object.

At 10:03 he was just west of Tri Cities Regional Airport when he was nearly struck by a "meteor" while at an altitude of 4,500 feet.

The pilot stated, "The meteor was in level flight and going "slow." Those of us who understand such things realize that meteors do not fly slowly, and not at 4,500 feet. The control tower at "Tri" had also received a few calls concerning a burning aircraft.

Immediately following this event, a witness in Johnson City, TN, reported seeing a large dark cigar-shaped object hovering near downtown.

"She described the object as "looking like one of those Vietnam helicopters (we assume a Chinook) without props."

The object, according to the witness, hovered, with its long portion some 45 degrees tilted up in the rear. It had a white light top and bottom.

It also had a large spotlight-like illumination on its front, pointing down. She assured the investigator that this was no helicopter, and that it made absolutely no sound. The object hovered for some time, then sped off quickly to the southeast.

Subsequently, at about 10:30 PM, a witness reported hearing a conversation between two police officers or sheriff deputies on a scanner in Carter County regarding a flying object. There were “chuckles” and a request that this subject be discussed by phone. Carter County 911 has no record of this discussion.

Polish pilots told to shoot UFO

Slupsk—Mr. Stanislaw Z reports, “I was on commanding duty as a navigator when we received information that radar tracked a UFO over Slupsk Military Airport on July 6, 1983, at 11:26 AM.

“Shortly an alert was announced, and Capt. Praszczalek was sent to make contact with the UFO. After several minutes, the pilot replied, ‘I can see the target. It is steel in color, rotating around its axis—a boomerang, without any engines nor markings.’

“It was decided to notify the General Command of Air Forces in Warsaw, and in 20 minutes the decision came ordering the pilot to fire on the UFO. The pilot attempted to intercept, but the object made a sharp turn and disappeared!

“Chaos reigned as navigators began registering thousands of unknown signals. For the next ten hours, military aircraft unsuccessfully searched the entire area.

“The next day the Military Special Service members began their investigation, but its final verdict isn’t known.” Thanks to Marcin Wawrzak, NPN © - <http://www.npn.ehost.pl/>.

New Jersey flying triangle

Lumbertson—The witness reports,

“I was up late, listening to music on my headphones on Oct. 12, 1979, and noticed out the west window three red lights in a triangle that appeared to be hovering.

“We lived near Burlington County Airpark so lights in the sky are no biggie. But there was no sound, and the lights were stationary. After about three minutes the lights began to move toward the south, and disappeared out of the west window only to reappear in the south.

“The lights continued to move, now seemingly upward and over the house, only to reappear in the west window again. It remained there for maybe a minute or so and suddenly veered southward at incredible speed and disappeared. I was so scared I could not talk.” Thanks to MUFON CMS

Argentina traces

Santa Rosa, La Pampa—Salvatore Valentin Carta, of Planeta UFO, reports that “on Saturday, Aug. 26, 2006, Mrs. O. had just finished watering her backyard about 8 PM, when she saw a dark red object with the appearance of a plow disc with lights around it.

“But the lights ‘were not solid, and it looked like each of them was a small spiral.’ Technically speaking, it was a vortex. The object remained static between a three-line barbed wire fence.

“The next day she noticed that the soil was drier than normal, and with a more solid consistency. I have ascertained that the barbed wire is darkened or covered by something resemble oxide; it is high resistance galvanized wire measuring 3 mm thick and was put up a year ago.

“Upon visiting her farm, a “fairy ring” was clearly visible on the property, measuring 2.50 meters (between seven and eight feet) in diameter.

“She also indicated that five days before she had seen a light to the northwest that she described as ‘a very large bottle shooting fire outward’ (plasma ionization?).

“The neighborhood dogs were quite alarmed. In the morning she found the grass as though burned and very dry

with regard to the surrounding vegetation.” (Special thanks to Salvatore Valentin Carta and Planeta UFO. Translation (c) 2006, S. Corrales, IHU.

Disc reported in Australia

“I was watching TV on Aug. 29, 2006,” says the witness, “when my satellite signal was blocked by something. I went outside to investigate and noticed a series of lights in the sky.

“Upon closer inspection, I saw the shape of the flying object; it was a disc-like shape. I stayed outside for about 20 minutes as the object came closer to the ground when suddenly a car backfired and the object began to fly away at a fast pace.

“It rose vertically until it disappeared completely in about two minutes. I was left confused about the incident.” Thanks to Always Vigilant, Lewis Grimwood.

Canadian chem trails?

Edmonton—“On Sept. 7, 8, and 9 the sky was inundated with chemtrails,” says the witness. “A UFO was filmed during a 39-minute filming of chemtrails. So much was going on during this film! A still-by-still examination of the UFO is revealing!

“The UFO appeared to be ‘overseeing’ the chemtrail spraying, which began before dawn and continued east of Edmonton until 7:30 AM.

“Meanwhile, another discovery—as one who has filmed chemtrails for eight years—was the nearby simultaneous aerosol spraying of both black and white chemtrails by the same lengthy black plane.

“One would do well to examine the DVD on a 72-inch screen, as well as slow it to the slowest-possible speed in film rendering software. There is so much going on in this film, I don’t know where to start.”

Thanks to Stephen Volk, MUFON CMS.

Iowa circular lights

Ankeny Airfield—The witness reports, “I was driving down Interstate 35 near Ankeny Airfield around 9:45

PM, on Aug. 26, 2006, and watched a craft, expecting it to descend. It had flashing bright white lights in a circular pattern.

“As we actually passed it, I could see it much more clearly because of the lights. It was hovering maybe a hundred feet above the ground immediately off the interstate, and it was black and triangular. I could even see the texture of it.

“It had lights on each corner, and they were flashing in succession. It was maybe 4 or 5 feet thick. I watched the object for probably a total of 2 minutes.”

Utah bright white trapezoid

Moab—The witness reports, “I was lying on my back on the lawn at 3:45 PM on Aug. 29, 2006, when I asked my companion, ‘What’s that?’

“We both observed a bright white trapezoid-shaped object moving across the sky at a walking pace and in a meandering manner, overhead.

“The object periodically stopped, rotated, or tumbled. Its apparent size was 1/4 thumb’s width. It was moving slowly north and had distinct edges. The Sun was high (about 45 degrees in the west) and southwest of the object, and would have been illuminating it.

“However, I noticed that there seemed to be no shadowing of the object on the side away from the sun. The object was uniformly illuminated, and I could tell it was rotating, because the edges and angles of the object moved as I watched.

“The object was quite white and shiny with a surface like highly polished white metal. I watched it for two minutes, then it was obscured by trees. My companion thought it was a balloon, but the shape was not consistent with a balloon and it flew fast across the sky.” Thanks to MUFON CMS

California square object

Hayward—“While driving on the 580 Freeway about 2:45 AM on Aug. 10, 2006,” says the witness, “I noticed a set of low flying lights coming just over the freeway from the east. The

Oakland Airport is to the west, so I just watched these lights approach.

“We were headed north, and the lights seemed to be going about six miles an hour. I figured they would cross right over us when we reached the top of the hill, where we would make our turn.

“The lights looked like huge car headlights, with a smaller diamond-looking light gracing either side of them. They looked like this...o-OO-o

“It had no lights flashing, and it banked a bit, and back, as they approached about 700 feet above the freeway. These lights were a soft goldish color, but they were still bright. There was no noise as the lights flew slowly over us.

“It was a near perfect square. No wings or fuselage, only a large light in each corner, the same size as the ‘headlights’ in the front, and the same color. Between each large light was a small light, so the object could have been octagon shaped. There was also a very tiny red light on each side of the object.

“There was a soft pearl-colored light in the middle. The lights on the object did not light the underside at all, nor did they flash. Even with all those lights, the object itself was blacker than pitch.

“Its intense blackness made it stand out even darker than the night sky, so with the placement of the lights, I could still perceive a great thickness about it, rather than it being flat.

“It was at least the size of nine large Cadillacs parked in a square, but it could have been larger. It was very much like a large flying lozenge. The whole sighting took six minutes.”

New Hampshire colored lights

Franklin—“I witnessed a strange event on the night of Dec. 1, 2004, with my two older children and fiance. We were watching a movie when above my curtains I saw colors of light, which were pink, blue, and red, oscillating around.

“I looked out the window and I saw beautiful colors going round and round. I yelled to my fiance to come look. Everyone saying what the heck is that? So my fiance ran outside and looked up,

and everything disappeared immediately. There was no noise.

“I was scared, so I called the police station in Franklin and asked them if there were any low flying planes or anything in the area?

“They asked me what happened, so I told them, and two of the cops mentioned that one week earlier they had a similar call from a man driving down Route 4 in Boscawen, seeing lights just like that.” Thanks to UFOINFO.

Two black objects in Indiana

St John/Cedar Lake—“On Aug. 17, 2006, at just after 9 PM,” says the witness, “I pulled into a gas station off Highway 41.

“Glancing up I noticed seven large discs in a military type formation approaching from the northeast.

“I am a six-year veteran of the USAF as a law officer stationed at both SAC and TAC bases, and know aircraft. These seven lights were moving fairly slow.

“There were four across, then one slightly behind on the left, and two slightly behind on the right, together looking like a flying wedge. As they approached, the outside discs pulled closer to the center four.

“Now losing its original formation it confirmed that this was not one aircraft with seven running lights. Then the seven discs moved closer, flying four to five hundred yards in altitude. They were flying at blimp speed, and headed north over Lake Michigan.

“They then accelerated and elevated at a remarkable pace. They were a clear, almost flat, white color, and large like a standard size door. I contacted both the St John and Cedar Lake Police Departments to see if anyone else had reported them. I was the only caller.”

Mexico object photographed

Tlalnepantla—Two months ago in June a disc-shaped object was video taped over the mountains.

The disc is estimated to be 25 feet in diameter, and similar to others often video taped in the region. Thanks to Scott Corrales, IHU. Translation (c) 2006.

The Truth About UFOs and Aliens by Tim Donovan, Publish America, Baltimore, 6x9 soft cover, 74 pages.

Reviewed by Dwight Connelly

Those of us who have been puzzled by the motives of our alien visitors need be puzzled no more. Tim Donovan has the answers.

Utilizing case reports and logic, he concludes that the aliens are here simply to gradually introduce themselves to the human race.

Dismissing out of hand the ancient astronaut and human evolution theories, he says that aliens are a comparatively recent phenomenon, and that abductions are done to gain attention, not to study humans or create hybrids.

Donovan suggests that the aliens are so knowledgeable that they do not need to study the Earth or humans, and so powerful that if they intended to do harm, they would have already done so.

The author contends that the aliens are already working with our government, but both parties are taking extreme measures to avoid admitting this.

Donovan says, in fact, that the UFOs have shot down military planes just to make it seem unlikely that the aliens and the government are cooperating—a little collateral damage.

Donovan's logic seems to come and go, and the "Alien Symbolism" chapter is more puzzling than enlightening.

If you like happy endings and prefer a positive view of aliens, this book is for you:

"Our rapid, exponential rate of progress," says the author, "means that we'll attain the Ets' level in a historically short time. No doubt the aliens want us to become part of their united system."

The eventual result, he says, is that "in perhaps a century or so our descendants will dwell in a virtual paradise. They will have all of the benefits of a far advanced civilizations without fear that technology will be used to destroy them."

There is, of course, no way of knowing if Donovan is right about all of this—but he is never in doubt.

Australian UFO Wave an admitted hoax

The Australian UFO website which showed 31 video clips of alleged UFOs between June and mid-August, now admits that 29 of the clips were hoaxes.

In April, 2006, the Australian Film Commission funded an experimental digital video project by director Christopher Kenworthy. The 31 video clips were distributed over the internet via websites and video podcasts.

Writers crafted background stories for the sightings, and reportedly answered numerous e-mails using a fictional persona.

"Very few people suspected that the clips were manufactured," says Kenworthy. "Gradually, the level of plausibility was reduced, but only when the last two clips were uploaded did a large number of people get suspicious."

Two of the UFO clips distributed were "quite genuine," according to Kenworthy, "and no researcher was able to pick which two they were." He did not identify these two clips nor explain how they had been evaluated.

No MUFON analysts have evaluated any of the clips.

However, ufowatchdog.com, which did question the clips, says the better ufologists thought the site was a joke.

Kenworthy said one goal of the project was "to improve research into videos of genuine UFOs. We want ufology to improve as a result of this experiment."

Another goal, he said, was "to show skeptics that they often rely on faith rather than evidence. Many skeptics made bold statements about the clips being nothing more than balloons, space junk, stars etc without doing their research. They were more easily misled than the ufologists."

Cell phone paging on CMS now available

The CMS development team continues to improve CMS and add new features and enhancements. The latest new feature is Cell Phone Paging on CMS.

You can now be paged immediately once a sighting for your state is received. This will give you greater freedom from having to check CMS or your e-mail all the time to see if you have a sighting waiting.

To enable this new feature, follow these simple instructions;

1. Login to CMS.
2. Click on "Edit My Profile."
3. Enter your cell phone number into CMS where it says "Cell Phone."
4. Click on the down arrow under the heading "Cell Phone Provider" and select your cell phone provider.
5. Click "SAVE."

Please test that it works and provide us your feedback. Your suggestions are always welcome. Please send them to janharzan@hotmail.com.

If you wish to discontinue Cell Phone Paging in CMS, remove your cell number from your profile and press Save. Then go back and re-enter your cell phone number if desired, but DO NOT select a provider. This will keep your Cell Phone number on file, but you will no longer receive pages.

Special thanks to Terry Groff and Tomas Karlsson for making this CMS enhancement possible.

Delbert Newhouse dies

Delbert C. Newhouse, 93, the Navy photographer who filmed a famous movie of about a dozen UFOs on July 2, 1952, near Tremonton, Utah, died Aug. 11, in Portland, OR, according to David Rudiak..

"I was told of Newhouse's death by David Cherniack, a Canadian documentary film-maker, who was just about to film an interview with Newhouse," says Rudiak.

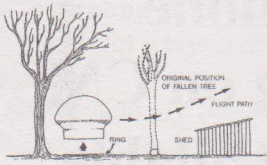

Physical Traces

By Ted Phillips

CE 2 events

As my files are slowly entered into an electronic database, I have entered cases in reverse order from 2006 back.

When the data has been saved in summary format, I will begin formatting to conform to the Pandora Project files. When completed, MUFON will have all of my files available for research.

The following will begin with a look at significant physical trace events from 2006 to 1980.

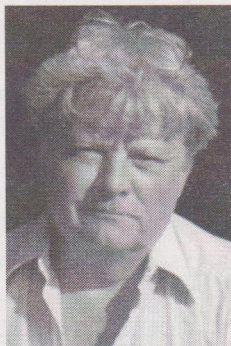

Ted Phillips

Odd light

On **June 17, 2006**, an odd light was observed near the ground near Casey, Iowa.

The report was given to me by Iowa State Director Jim King, along with soil samples taken in the flight path. These samples are being tested.

The witness was awakened by her dog barking, indicating it needed to go out at 0230. As she waited on the dog, she saw a flash of light on a hill south of the house near a storage shed.

As she watched, it reappeared down the hill toward the house. It appeared to be a solid light which flashed off and on. It was moving down the hill at an estimated ten feet at a time, and was some five feet off the ground.

This same thing happened 6 or 7 times until it was about 15 feet from the house. At the near point it turned to the right and flew into the woods. Soil samples were taken, due to the proximity of the object to the ground.

Two burned rings

Jan. 23, 2006, near Crespo, Uruguay. At 3 AM, Enrique Hurtado and

his mother were awakened for no apparent reason. They looked out the window and didn't see anything unusual, but dogs were barking at the time. They went outside at sunrise and found two burned rings, each 15 paces in diameter. While no object was seen, circular burns should be checked by soil analysis.

Burn marks left

On **May 8, 2004**, at 10 AM, near Havana, Cuba, a silver object was observed by Raul Beltran after he saw a bright light through the window.

"It was like a glowing ball with a tail in its lower section," he explains. "I showed it to my mother quickly and ran outside to see where it would fall."

Raul's mother said, "It was small and glowed a lot; it looked like a mirror."

The object landed in an open field surrounded by trees on a farm near Havana.

"It lifted off rather perpendicularly," says Raul, "and then it left through the palm trees. It didn't make any noise nor issue any smoke."

"The only thing I'm sure of is its size; more or less the size of a pickup truck tire or thereabouts."

Remigio Sanchez, at a school nearby, claims to have observed a light in the sky at the same time: "It was a powerful glow. When I got to Raul's home, they told me a device had landed nearby."

The grass and small plants at the spot where the object landed were somewhat burned.

Guard loses consciousness

On **April 10, 2004**, 44-year-old Eduardo Perez, a security guard at a high scale condominium, was in his guard shack when he saw a strong luminosity coming from outside. As he

went out he lost consciousness.

He was found later by another guard 600 meters away from his post in a state of confusion, and with a three-day growth of beard, the hands of his quartz watch were turning in the opposite direction.

His superior touched the man and was thrown back by a violent discharge of static electricity. Local police found odd ground traces at the nearby golf course.

Markings on pavement

March 12, 2004. The witness was driving at 4 AM near Sault Sainte Marie, Canada, when he saw a beam of light hovering from the top of a hill. His vehicle stopped, and he saw a small dark figure.

He found himself 100 feet from the figure and beam, heard a loud pop, and saw a bright light ascending. He found three circle-shaped burn markings on the pavement.

Object leaves depressions

Feb. 10, 2004. At Meanwood in Leeds, UK, Raymond Mulhall and seven other witnesses, including two policemen, observed an object 16 meters (50 feet) in diameter and 6 meters (18 feet) thick descending without sound.

It appeared to land in an area named "The Witches Quarry." They found damaged trees and three triangular depressions in the ground.

These were 7.7 meters (25 feet) apart, and depressed into the ground to a depth of 20 centimeters (8 inches). Heat could be felt rising from the soil.

Light leaves ring

Dec. 15, 2003, at Louisburg, MO. The witness reported, "On the night of 12/15/2003, as my wife and I were pulling up to our driveway after a dinner

out, we noticed a bright light back in our fields. We live on a farm, and our fields extend out for a mile behind our house.

"It was raining, and the air was thick as fog. But we could see this bright light in the field. The light shoots straight up into the sky, disappearing into the clouds. I didn't see anything but a big ball of light.

"The next day we walking about half a mile and found a ring 10 feet in diameter. I never believed in UFOs before, and had never seen anything like this." The ring was depressed with the central area undisturbed.

Entities stop car

Aug. 11, 2003, at Szczecinek, Poland. Lech Hacinski was driving home after work at 5 AM when he saw three figures. One left the others and walked to the middle of the road with one of its hands raised up.

Lech was forced to stop his car, and the figure asked him questions about his car and how it operated.

It then floated to the others and they all floated to a nearby field where a large dark round device rested on the ground.

The bottom of the device was surrounded by fog. The figures disappeared into the object, and it ascended to the west at very high speed.

On the field where the object had landed a 50 meter (150 feet) wide circular area of flattened wheat was found. This is one of several interesting events I investigated in Poland, the Czech Republic, and Slovakia during one of my trips there.

Light and entities

Aug. 8, 2003 at St. Laurent, Canada. Four witnesses were in a car when they saw a flashing light over and above buildings on a golf course. The lights were hovering in one area and very low to the ground.

The witnesses thought someone might be breaking into the buildings, and two of them went into the area to investigate. When in the area they heard a loud, piercing scream.

They walked another 100 feet and a three-foot tall being ran in front of them 25 feet away. Both men ran toward the road as the others arrived. They found unusual holes in the ground throughout the area.

Woman floated towards object

May, 2003, Moscow, Russia, region. A woman and her mother were sitting on the porch when they saw an unusual cloud.

Later in the night they were both awakened with severe headaches and an odd vibration.

A bright beam of light came through the window and moved across the room. As soon as they were out of the light the headache ceased.

The daughter went to the porch and saw a pear-shaped "cloud" just like the one seen earlier. It was now brighter, with silvery-blue beams of light and a protrusion resembling an antenna.

She ran toward the "cloud," and suddenly her body felt weightless, and she seemed to float above the ground.

She floated quickly toward the object, and when she was less than 2 meters (6 feet) away she fell and lost consciousness. She regained consciousness three hours later, lying on the cold ground.

She and her mother went to the spot where the object had been and found a circular burnt patch on the potato bed. Nothing grew on the area for three months.

Object enters water

April 18, 2003, Kaliningrad, Russia. At 6:17 PM a large number of local residents observed a "flying wing" fly over at high speed and plunge into Kaliningrad Harbor.

The event was caught on video by a local RTR Russian State Television news crew, which was filming a documentary on the Russian Baltic Fleet.

A Russian Naval Commander stated that the object had been tracked on radar.

The light-colored gray device, with no visible seams or rivet patterns, was estimated to be the size of a small airliner, with no sound. Radiation was re-

portedly detected, and debris less than one meter in size was recovered.

Vanishing object and entities

Feb. 23, 2003, Las Pailas, Argentina. At 9 AM 24-year-old Milagros Linquin had gone into a rocky hillside to retrieve her goats when she noticed a shiny object on the nearby hill.

Close to the summit was a metallic object similar to a bus, rectangular in shape with numerous windows and doors on one of its visible sides. She counted eight windows.

The object appeared to be made of a shiny metal which reflected the Sun. Around the device she saw other shiny objects, square in shape, some larger than the others. She counted 14 of these.

At this point, her father, 74-year-old Don Linquin, came up and observed the same details. Milagros had climbed closer and saw several human-like figures, wearing white tight-fitting garments, moving around the main object.

They appeared to be working on the metallic square objects. There were six figures visible.

The father also noted, a little further down from the summit three additional human-like figures dressed in black tight-fitting outfits.

After about 30 minutes, Milagros climbed higher in order to approach the object and the figures, but when she did, the whole scene appeared to have vanished.

They went to the site and found a deep rectangular track in the ground.

Object strikes car

Dec. 29, 2002, Benson, NC. Linda Moore was driving her Toyota west on I-40 with her cousin, Vicki Wright, in the front passenger seat, and Mrs. Moore's two nieces in the back seat.

Vicki saw a black object traveling at high speed approaching from above a tall pine tree and hitting the car just in front of the side mirror.

The 14-year-old niece also saw the object approaching. The object gouged a large dent in the car and scratched off paint. The object was not found. The event took place in daylight at 4:20 PM.



PERCEPTIONS

By Stanton T. Friedman

Unscientific CSICOP

Over the past few years I have pointed out that a more accurate explanation for the acronym SETI than the intended one of Search for Extraterrestrial Intelligence is "Silly Effort To Investigate."

I wish I could come up with a suitable replacement for CSICOP. It is supposed to stand for Committee for the Scientific Investigation of Claims of the Paranormal.

They cover a lot of ground—with as much or more arrogance as the SETI cultists. Perhaps the simplest would be Committee for the Unscientific Investigation of Claims of the Paranormal.

The trigger for this column is a combination of two recent press releases.

One is a listing of 10 "best" UFO-related claims. The other is sort of a self tribute to CSICOP from Kendrick Frazier, editor of CSICOP's *Skeptical Inquirer* (CSICOP is good at press releases) in honor of their 30 years of saving the world from ignorance, false beliefs, etc.

Of course he doesn't mention the irrational unscientific claims made by CSICOP.

CSICOP has taken full advantage of having very respectable people on their own list. They include Nobel Prize winners and well-known writers and scientists such as Isaac Asimov and Carl Sagan.

Unfortunately, one finds that CSICOP (and its high status members) itself does precious little research. Very often their science is done by others such as the late Philip Klass, who made a mockery of scientific investigation.

The chief investigator for CSICOP is a paid employee, Dr. Joseph Nickell. However, he has three degrees in English and a long connection with the world of magic (not MAJIC).

Magicians such as the Amazing

Randi (sort of officially disfranchised by CSICOP because of some legal troubles) have often taken the lead.

Almost all the CSICOP efforts are based on a host of such silly assumptions as obviously there are no alien visitors, therefore no alien abductions, therefore no recovery of wreckage of an alien spacecraft at Roswell or any-

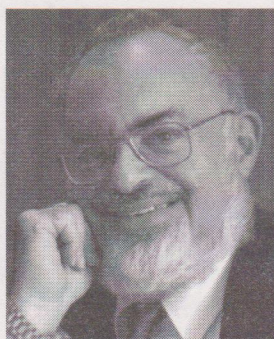

Stan Friedman

where else. Their stock in trade is the use of the tools of the propagandist, such as selective choice of data, positive and negative, name calling, false reasoning, etc.

I have had several close encounters with Nickell. For example, he claimed that the Eisenhower Briefing Document (an important Majestic 12 item received in 1984 on a roll of film) was obviously a fraud because the date format of 18 November, 1952 violated the US Government style manual because the comma should not have been there.

However, I had discovered examples of this same format as used by two MJ-12 members (CIA Directors W.B. Smith and Roscoe H. Hillenkoetter).

Furthermore, at the various Presidential libraries and others of the 20 archives I have visited, I found many different date formats for those pre-computerized years.

One file folder had seven different date formats. I published in my "Final Report on Operation Majestic 12" three brief items from CIA Director Allen Dulles to Presidential Staff Secretary Andrew Goodpaster written within a 10-day period in 1956 having three different date formats.

Nickell, as reported in Frank Feschino's book *The Braxton County Monster: Coverup of the Flatwoods Monster Revealed*, claimed that the explanation for the "monster" which scared a bunch of people near a big tree on a hillside in Flatwoods, WV—after a UFO landing and the emission of a sickening gas—was a 6-foot tall owl!

He did visit Flatwoods, but didn't visit the site of the event nor talk to the key witnesses still alive. This hardly qualifies as a scientific investigation.

He and other csicopians make much use of the four basic rules of debunkery: . 1. What the public doesn't know, I am not going to tell them. 2 Don't bother me with the facts, my mind is made up. 3. If I can't attack the data, I will attack the people, it is easier. And 4. Do one's research by proclamation, because investigation is too much trouble.

We had another close encounter, this time with me in front of a camera in Roswell, and Joe in front of one in Los Angeles. He "knew" that the explanation for Roswell was that the PR guy made up the story to get attention!

I said, "You don't even know his name, do you?" "Well, no." I said, "It was Walter Haut. I have been in his home and had meals with him. He is extremely well respected in Roswell for his community activities.

"He had an outstanding record during WW 2 as a bombardier navigator in over 20 bombing missions over Japan. He was selected to drop the instrument package to obtain measurements during the explosion of an atomic bomb in Operation Crossroads in the Pacific in 1946.

"His outfit, the 509th Composite Bomb Group, was the most elite military unit in the world, having also dropped the two atomic bombs on Japan. The notion that he would have made up a story is totally absurd."

Carl Sagan has said, "There are in-

teresting UFO sightings that are not reliable and reliable sightings that aren't interesting, but there are no interesting and reliable sightings." No reference was given, no source mentioned.

This proclamation is flat out false, as demonstrated by the Quality Evaluations of "Project Blue Book Special Report 14," which showed that for 3,201 sightings, the more reliable the sighting, the more likely to be unexplainable.

Isaac Asimov was sent a copy of my MUFON paper, "UFOs: Myth and Mystery," and responded with two of the silliest articles on record in *TV Guide* and *Fantasy and Science Fiction*. They were loaded with false claims and, surprisingly, with a lot of silly, unscientific reasoning.

I discussed these in detail in "Flying Saucers, Science Fiction and UFOs." I received a postcard saying he had received a copy, but would henceforth not reply.

The *Skeptical Inquirer* this summer issued a list of top 10 UFO stories with brief and gross descriptions. Alien abductions (Number 2) brought forth this claim:

"There may be several causes of the alien abduction experience. Many of these experiences are only recovered years later, during psychological treatment for other issues. Research has proven that false memories can be created in the course of therapy by careless psychologists.

"People can actually come to believe they were abducted or abused, whether or not they have been. Other researchers have shown that a common psychological process called sleep paralysis may be misinterpreted as an alien abduction (reference to Susan Blackmore's work in the UK)."

And Barry Bonds may strike out sometimes. Which of course has nothing to do with whether he hits home runs. Pretty silly stuff.

Number 1 on the list was The Roswell Incident. "The most famous UFO crash in history occurred in 1947 on a ranch just outside of Roswell, a dusty New Mexican town."

The site is actually about 80 miles

from Roswell, the last 10 without a road,

Yes, Roswell was dusty, as with so many desert areas. It was also the home, as noted above, of the most highly rated military group in the world.

People involved in the event included the base commander, Col. Blanchard, who went on to become a four-star general and was vice-chief of staff of the USAF when he died of a heart attack at the Pentagon; Retired Gen. Thomas Jefferson Dubose, chief of staff to General Roger Ramey, head of the 8th Air Force; Maj. Jesse Marcel, intelligence officer of the 509th; and the aforementioned Walter Haut.

There is no mention of any of this, which is as silly as the failure of the Peter Jennings UFO show to take note of the fact that interviewee Jesse Marcel Jr. was a colonel in the Army, a medical doctor, flight surgeon, and helicopter pilot who served a year in Iraq starting at age 67. He had handled Roswell wreckage.

His credibility would have been enhanced if any of these facts had been noted. Jennings and CSICOP would probably think it OK to describe Harry S. Truman as a well known Missouri haberdasher, and not mention that he served 10 years in the US Senate, was elected vice president, and then President, serving seven years in the latter office.

"There was indeed a cover-up of what crashed outside Roswell, but authorities were hiding, not a crashed alien saucer, but a weather balloon from a secret spy program called project Mogul. The debris described by the original eyewitnesses exactly matches the balloons used in the program."

Talk about silly!

None of the components were secret. Mogul had standard conventional neoprene weather balloons. Mac Brazel had recovered two earlier, and stated that what he recovered was not a weather balloon.

The balloons rot pretty quickly in the sun. None had foil-like memory metal that could be bent, but returned to its original shape after being folded, and could not be torn.

None had I-beams which were very light weight, could not be broken or burned, and which had lavender colored strange symbols. Marcel and Blanchard were familiar with weather balloons. The debris field was much too large for a Mogul balloon, etc etc. Siliness is the name of the game.

A survey conducted by *Industrial Research and Development Magazine* showed that about 2/3 of engineers and scientists involved in Research and Development activities accepted the reality of UFOs.

Gallup Polls have shown that the greater the education, the more likely to accept UFO reality.

The Amazing Randi demonstrated his ignorance of astronomy in an attack on the Marjorie Fish star map work related to the Betty Hill UFO abduction in his book *Flim Flam*.

He even placed the Hill story in John Fuller's *Incident at Exeter*, rather than in the *Interrupted Journey*, and obviously didn't understand what Marjorie Fish did or the relationships of stars in a constellation to each other..

A splendid example of CSICOP's silly, unscientific, vicious debunkery involved their treatment of one of their original founders, a scientist, Dennis Rawlins, when he pointed out that in their attack on astrology-related work by Michel Gauquelin, they had cheated and tried to shoot the messenger rather than dealing scientifically with the data. Rawlins resigned.

Anybody who admires CSICOP should read Jerome Clark's outstanding article in the UFO Encyclopedia or STARBABY by Rawlins (cura.free.fr/xv/14starbb.html). A good historical overview, though dated, is "CSICOP and the Skeptics: An Overview" by George P. Hansen." www.tricksterbook.com/ArticlesOnline/CSICOPoverview.htm

My point here is not to defend everything related to anything paranormal. It is to make people aware that almost no attacks on ufological material by CSICOP can be trusted to be honest, fair, or scientific.

www.stantonfriedman.com
fsphys@rogers.com

Directors' Message

(Continued from page 2)

IN; Rev. **Carol Breen** of West Palm Beach, FL; **Patty Donahue** of Eagle, MI; **Pat King** of Albia, IA; **Ken Pfeifer** of Monroe-ville, NJ; **Rafael Sanchez Navarro** of San Jose, CA; **Dianne Phipps** of Live Oak, TX; **Jeremy Ray** of Sacramento, CA; **Tyron Cole Thompson** of Muncie, IN and **J. D. Wilson** of Del City, OK; have passed the MUFON Field Investigator's Exam and are now MUFON Field Investigators.

All Field Investigator Trainees are urged to self-study the *MUFON Field Investigator's Manual* and take the exam. The manual is available from MUFON Headquarters for \$25 plus \$3.50 p&h in the U.S. Total price for delivery outside the U.S. is \$49.50. It may also be purchased via the Internet at www.mufon.com using PayPal.

James Carrion's Report

I have been taking advantage of the short time that I have left before officially assuming the International Director position on Nov. 1 to work on a number of important transition items.

The two warehouses in Denver were emptied, and their contents stored at my home in Bellvue, CO. Colorado MUFON was instrumental in assisting with this move, and all of their hard work is appreciated.

The new MUFON office is coming along quite nicely and will feature a UFO library from the many books and periodicals MUFON has collected over the past 36 years.

The library holdings are being inventoried, and the results will be posted on the MUFON web site.

If you have UFO-related books that you would like to donate to the MUFON library, please send them to MUFON, Post Office Box 279, Bellvue, CO 80512-0279. Any duplicates will be sold, and the monies deposited in the MUFON Special Projects Fund.

Having inherited all the MUFON administrative files, I have been also delving into the history of the organi-

zation and its inner workings. One of the many goals I have set for myself is to beef up the content on the MUFON web page to include an in-depth history of MUFON so we can share our proud heritage with the rest of the world.

While perusing the administrative files, I have the records of a number of historical volunteer efforts and ideas, some that were completed and some that never really got off the ground.

I am recycling the best of these ideas for future implementation to ensure MUFON is a dynamic organization that constantly strives to meet its mission and goals while enhancing the services it provides to its members.

If you have any suggestions or ideas you would like to share with me to improve MUFON as an organization, please email them to jcarrion@mntview.com.

I am working closely with the new MUFON Director of Investigations, Chuck Reeve, who has been hard at work rewriting the *MUFON Field Investigator's Manual*. We will all be very happy with the new manual.

MUFON still has a couple of key vacant volunteer positions that we would like to fill this year—the MUFON Director of Research and the MUFON Director of Public Education.

If you are interested in one of these positions, please send a letter of introduction and your resume to jcarrion@mntview.com.

John Schuessler's Report

This is my last Director's Report as the MUFON International Director. All future reports will come to you from our new leader, **James Carrion**.

Although I was a founding member of MUFON in May, 1969, and an active member from that time forward, I never realized the scope of the job was so broad until I was elected to the position of International Director in 2000.

Leading MUFON for the past six years has been a very important and intriguing job. I want to thank you all for your support and guidance.

I could write a book about all the

things I have learned during this time period, but some of the things that stand out in my mind are as follows:

·UFOs are real, and they are not ours. We have thousands of pieces of evidence that would stand up in a court of law attesting to this fact.

·The *MUFON UFO Journal* is an international treasure. It has been published on a regular basis since the month the organization was born, and continues to this day, bringing you the latest and best UFO news. Our dedicated editor makes sure it is published on time and is loaded with useful information and reports.

·MUFON has a fantastic cadre of leaders, field investigators, research specialists, and consultants, all volunteering their time, energy, and money to fulfill MUFON's mission—"The scientific study of UFOs for the benefit of humanity through investigation, research, and education."

·MUFON members are some of the finest, nicest, and most capable people that anyone could want to work with.

·In addition to being fascinating, UFO work is difficult, demanding, and exceedingly important to the future of the planet.

·The MUFON Business Board of Directors is doing a very effective job of providing direction and guidance for MUFON operations. They are paving the road that makes the organization viable well into the future.

·We have dozens of projects planned for the future. Each one will make a difference in the UFO field. They need to be worked—and soon.

·Financing the new projects is extremely difficult because there are so many causes out there demanding support from all funding sources. MUFON needs funding for this very important work.

Kathy and I want to thank you all for your friendship, support, and assistance. We are not leaving MUFON. We are just moving into a less demanding position, so we look forward to hearing from you from time to time and seeing you at future MUFON events.

BEYOND ROSWELL

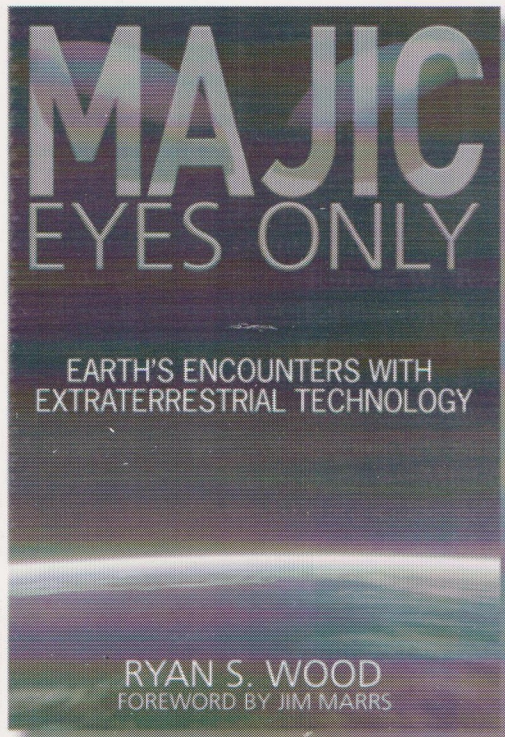

Landmark synthesis and review of every credible UFO Crash Retrieval

- Covers 74 UFO crash events, starting in 1897 with Aurora Texas
- A dozen UFO Crashes before the 1947 Roswell events
- Never before seen pictures of UFO crash debris and Top Secret documents
- Authenticity ratings for each crash event

10-06

NOW AVAILABLE
WWW.MAJICEYESONLY.COM
720.887.8171

LEARN THE TRUTH

2000: UFO FLAP IN REMOTE AZ AREA; GOV/MILITARY & MURDER & COVER-UP; ALTERNATE "AREA 51"?

2000-2005: COPTER HARASSMENTS; ATTEMPTED MURDER; PHONES CONTROLLED AND BUGGED; NUMEROUS SIGHTINGS; SHOCKING PHOTOS; MUCH MORE.

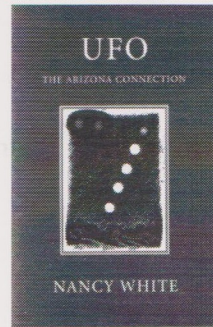

**"UFO-
THE ARIZONA
CONNECTION"**
 BY
NANCY WHITE

Send check or M.O. for \$20 (includes S&H) to:
 George Parks, AZ MUFON State Dir.,
 630 W. Paseo Norteno
 Tucson, AZ 85704-4641

The Largest Selection of UFO Products on the Internet



Send for our
**FREE UFO
 Products Catalog**

- Hundreds of UFO documentaries on DVD and VHS
- Vintage UFO radio shows
- Gifts & Accessories

www.theUFOstore.com

24 hour Order / FAX line at
541.523.2630

theUFOstore
 1930 Ash Street, Suite 9M
 Baker City, Oregon 97814, USA

email: sales@theUFOstore.com

Advertising rates

	1x	3x	6x
Back cover	\$450	\$425	\$400
Inside back cover	\$425	\$400	\$375
Full page	\$350	\$325	\$300
1/2 page	\$250	\$225	\$200
1/4 page	\$150	\$125	\$100
"Calling card"	\$55	\$50	\$45

For advertising, contact John Schuessler at
 schuessler@mho.net, 303-948-6224



The Night Sky

By Gavin A. J. McLeod

November sky

Moon Phases:

Full Moon: Nov. 5
Last Quarter: Nov. 12
New Moon: Nov. 20
First Quarter: Nov. 28

Bright Planets (Evening Sky)

Venus (magnitude -3.8): Moving from Libra into Ophiuchus. For northern hemisphere observers, Venus will not be observable until early December. For more favored southern hemisphere observers, Venus will slowly emerge in the west-southwest evening twilight in the last week of November.

Mars (magnitude 1.6): Moving from Virgo into Libra. For northern and southern hemisphere observers, Mars will not be visible this month.

Jupiter (magnitude -1.7): In Libra. For northern hemisphere observers, Jupiter will not be observable this month. For more favored southern hemisphere observers, Jupiter may be glimpsed early in the month very low in the west-southwest after sunset.

Bright Planets (Morning Sky)

Mercury (magnitude 1.3 to -0.2): In Libra. For northern hemisphere observers, Mercury will emerge in the east-southeast morning twilight in the second half of the month. This will be the best viewing of the year for northern observers. For less favored southern hemisphere observers, Mercury will remain very low in the east-southeast before sunrise at month's end.

Saturn (magnitude 0.5): In Leo. For northern hemisphere observers, Saturn will rise near 11 PM in the east-northeast, and will stand nearly 60 degrees high in the south-southeast at the beginning of morning twilight. For southern hemisphere observers, Saturn will rise before 1 AM in the east-northeast and will stand about 30 degrees high in the north-east at the beginning of morning twilight.

Procyon.

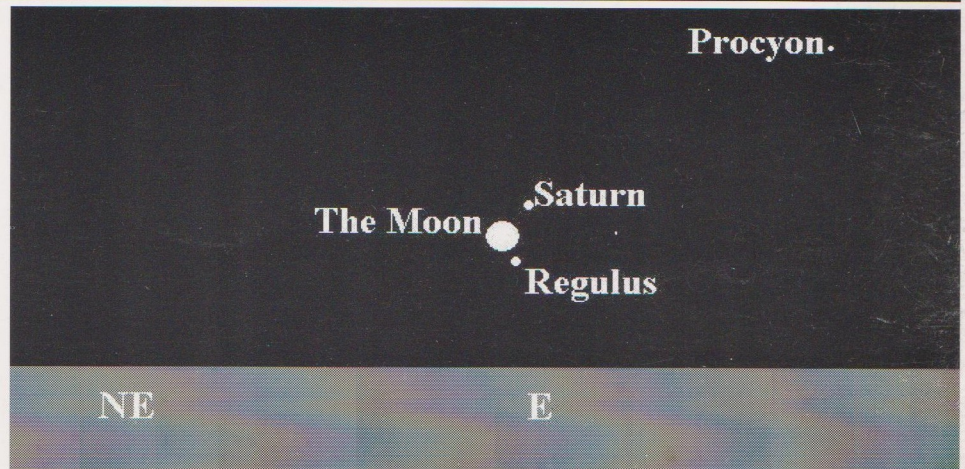

Before sunrise on Nov. 28.

Other Celestial Phenomena:

Meteor Showers

South Taurids: The South Taurids will peak on Nov. 4-7. This is a minor meteor shower which will be further weakened by the presence of the full Moon.

North Taurids: The North Taurids will peak on Nov. 12. The North Taurids are also a minor meteor shower which will also be diminished by the presence of the full Moon.

Leonids: Peaking on Nov. 17. The Leonids meteor shower is probably the most famous meteor shower of all after the high hourly rates of a few years ago. This shower is the result of the Earth's passage through the dust and debris left by the comet 55P/Tempel-Tuttle.

Comet 55P/Tempel-Tuttle returns to the inner solar system every 33 years. Each time it passes through our part of the solar system, it leaves a trail of dust along its path. These small grains of dust become the bright and beautiful meteors in our skies.

In 2006 the Leonids will certainly not be at meteor storm levels, but there is a reasonably good chance we'll see somewhat higher than average hourly rates, as many as 150 per hour, due to the Earth's passage through a dust stream left during Comet 55P/Tempel-

Tuttle's 1932 passage through the inner Solar System. Fortunately the Moon will not obscure any of these meteors for us this year.

Conjunctions and Occultations

Nov. 13: Saturn 1.6 degrees south of the Moon.

Nov. 18: Spica 0.6 degrees north of the Moon.

Nov. 19: Mercury 6 degrees north of the Moon.